



2022

catalogo
listino prezzi

catalogue
price list



MUNDIAL

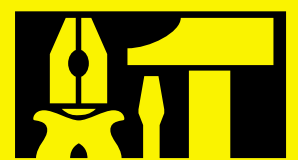

Utensileria Alfredo Casartelli **ITALY**

utensili professionali

www.mundial-casartelli.it

professional tools



Misura
Measure

Numero articolo
Article number

Numero pezzi per confezione
Pieces number for package

Prezzo
Price

Codice
Code

Numero pezzi nella serie
Pieces number in set

Aggiungere al codice "-9" per ordinare nella confezione self-service vedi codici pagina 209
 Add "-9" to the code to order in the self-service package see codes page 209

Codice a barre
Bar code

1030.055-9	5,5-5,5	8011578030001	00,00
1030.060-9	6-6	8011578030018	00,00
1030.070-9	7-7	8011578030032	00,00
1030.080-9	8-8	8011578030070	00,00

- Pro**
INDUSTRIAL
- Quality**
GARANITTI
GUARANTEE
- Cr-Mo**
CROMO-VANADIO
CHROM-VANADIUM
- x5**
- DVE**
- COMOCRIP**
MUNDIAL



pagina
12
page



pagina
18
page



pagina
38
page



pagina
56
page



pagina
61
page



pagina
86
page



pagina
102
page



pagina
108
page



pagina
114
page



pagina
148
page



pagina
152
page



pagina
182
page



pagina
209
page





dal
 since **1929**

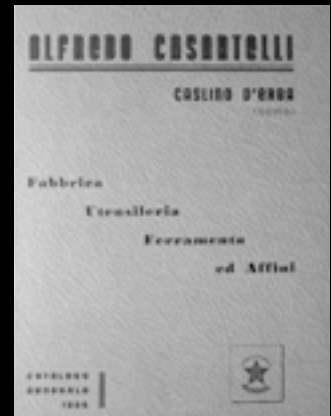



dal 1929 produzione e distribuzione utensili professionali
 since 1929 professional tools manufacture and distribution



qualità garantita
 quality guarantee

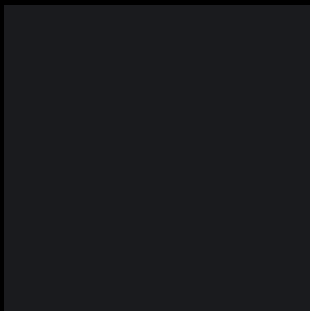

gamma completa
 complete range

Mundial Alfredo Casartelli srl produce e distribuisce utensili a mano professionali. Qualità, design, innovazione e competitività sono caratteristiche che dal 1929 accompagnano i prodotti Mundial sul mercato nazionale ed internazionale. Mundial offre una gamma completa di utensili professionali: giraviti, pinze, chiavi, chiavi a bussola, scalpelli, martelli, carrelli portautensili... tutti prodotti con materiali selezionati e con le tecnologie più innovative frutto dell'esperienza acquisita in oltre 70 anni d'attività.

Mundial Alfredo Casartelli s.r.l. is a manufacturer and distributor of professional hand tools. Since 1929, quality, design, innovation and competitiveness are Mundial's leading features, both on national and international markets. The firm offers a full-spectrum range of professional tools: screwdrivers, pliers, wrenches, sockets, chisels, trolleys... all made of selected materials and employing the most innovative technologies developed over a more than 70 year-long activity. Mundial range addresses professional workers in the fields of hardware tools, industry, automotive, electric, hydraulics, building, always providing high quality standards.



La gamma Mundial si rivolge ai professionisti dei settori utensileria, industria, autoriparazione, elettrico, idraulica, edilizia... garantendo alti standard qualitativi. Il continuo impegno aziendale è rivolto al miglioramento dei materiali alla realizzazione di nuovi prodotti e allo sviluppo di nuove impugnature ergonomiche. Mundial supporta la distribuzione con espositori specifici per categoria di utensili e propone l'intera gamma anche in confezione self-service appendibile per la vendita a libero servizio.

Mundial's ongoing engagement is focused on material improvement and new products manufacturing, not to mention developing new ergonomic handles. Category-based displays underlie Mundial's distribution; moreover, hanging self-service packaging are available with the whole range of products, focusing on self-service sellings. Nowadays, Mundial's image on the market represents its great tradition along with modernity and an ongoing renewal to offer customers a complete and steadfast service.



servizio al cliente
 customer care

Mundial attualmente si propone sul mercato come un'azienda di grande tradizione ma moderna ed in continuo rinnovamento per dare sempre un servizio completo e costante alla clientela.

Mundial's image on the market represents its great tradition along with modernity and an ongoing renewal to offer customers a complete and steadfast service.



carrello-pro trolley-pro



piano di lavoro in ABS con divisori
ABS top with grid

paracolpi angolare
angular bumpers

chiusura ANTIRIBALTAMENTO apertura singola cassetti
one drawer opening safety system

ruote rinforzate
reinforced wheels

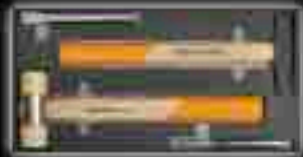

professional

professional

professional



carrelli per utensili con moduli morbidi in spugna bicolore

- resistente a prodotti chimici
- bicolore per immediata identificazione utensili mancanti
- sagomatura precisa per ogni utensile
- moduli intercambiabili con altri tipi

trolleys for tools with soft sponge double colour modules

- chemical product resistant
- double-colour for missing tools identification
- precision profile for each tools
- interchangeable modules



utensili isolati
certificati VDE 1000 Volt 60900
impugnatura bicomponente
ergonomica

*insulated tools
VDE 1000 Volt 60900 certificated
ergonomic bicomponent handle*



Pro
INDUSTRIAL





COMMOGRIP

giravite professionale
impugnatura bicomponente
ergonomica

lama in acciaio
chrom-molibdenum HRC60

*professional screwdriver
ergonomic bicomponent handle
chrom-molybdenum steel HRC60 blade*



foro per appendere
hanging hole



profilo triangolare
per trasmissione sforzo
*triangle section for
force transmission*



sezione cilindrica
per rotazione rapida
*cylindric section
for fast rotation*



codice a barre e simbolo
bar code and symbol



acciaio - *steel*
chrom-molybdenum
durezza - *hardness* HRC60

professional





cassette chiavi a bussola
blow case sockets



chiavi combinate a cricchetto
snodate - reversibili - semplici

combination wrench
flex - reversible - simple



180°

72 denti - teeth



5° ripresa



mm 8 ÷ 24



acciaio-steel
chrom-vanadium
standard ISO





forbici per elettricisti - professionali
scissors for electricians - professional



pinze e tronchesi universale
a leva grande effetto - industria
*high leverage combination
pliers and nippers - industrial*





martelli professionali
professional hammer



utensileria tools



0010 Espositore 572 utensili - **UTENSILERIA**
 Display stand 572 tools - **TOOLS**

Contenuto - content:
 0068.010 Nr. 1
 0439.410 Nr. 1
 0439.915 Nr. 1
 1050.015 Nr. 1
 1064.015 Nr. 1
 1570.015 Nr. 1
 0062.010 Nr. 2

Dimensione-dimension: mm 1000 x 450 x h. 2050

0010.015 572 PZ. **3.776,20**

punto vendita-sales point
mundial merchandising
 esposizione organizzata
 organized exhibition

- espositori personalizzati e funzionali
 per categorie di utensili
 special display for each tools range
- riduzione dello spazio espositivo
 reduced exhibition area

0020 Espositore da parete - **VUOTO**
 Wall display stand - **EMPTY**

Per espositori / For display stand:
 0010 - 0012 - 0014 - 0015 - 0016 - 0017

Dimensione-dimension: mm 1000 x 450 x h. 2050

0020.210 vuoto/empty **400,00**





industria industry

0012 Espositore 480 utensili - **INDUSTRIA**
 Display stand 480 tools - **INDUSTRY**

Contenuto - content:

0077.010	Nr. 1	0478.010	Nr. 2
0096.010	Nr. 1	0347.090	Nr. 6
0344.990	Nr. 1	0351.090	Nr. 6
0439.510	Nr. 1	0366.090	Nr. 6
0623.010	Nr. 1	0593.910	Nr. 2
1100.015	Nr. 1	1070.020	Nr. 2
1150.080	Nr. 2	1070.025	Nr. 2
1150.100	Nr. 2	1070.030	Nr. 2
1150.130	Nr. 2	1723.001	Nr. 1
1150.170	Nr. 2	1350.035	Nr. 1
0376.035	Nr. 2	1350.050	Nr. 1
0380.030	Nr. 6		
0380.050	Nr. 6		
0474.025	Nr. 2		

Dimensione-dimension: mm 1000 x 450 x h. 2050

0012.015 480 PZ. **4.510,60**

idraulica hydraulics

0014 Espositore 143 utensili - **IDRAULICA**
 Display stand 143 tools - **HYDRAULICS**

Contenuto - content:

0502.054	Nr. 2	0492.024	Nr. 6	1070.030	Nr. 4
0502.040	Nr. 2	0770.022	Nr. 2	1070.025	Nr. 4
0502.032	Nr. 2	0772.032	Nr. 2	1070.020	Nr. 4
0502.025	Nr. 2	0773.010	Nr. 2	0560.025	Nr. 4
0502.740	Nr. 2	0774.032	Nr. 2	0561.010	Nr. 2
0502.732	Nr. 2	0777.127	Nr. 2	0562.010	Nr. 2
0503.030	Nr. 2	0782.002	Nr. 1	0563.010	Nr. 2
0503.041	Nr. 2	0790.042	Nr. 2	0564.010	Nr. 2
0503.052	Nr. 2	0792.042	Nr. 2	0565.010	Nr. 2
0503.062	Nr. 2	0794.063	Nr. 2	0566.010	Nr. 2
0504.025	Nr. 2	0796.100	Nr. 2	0567.010	Nr. 2
0504.030	Nr. 2	0798.240	Nr. 2	0568.010	Nr. 2
0504.725	Nr. 2	0500.022	Nr. 2	0351.090	Nr. 6
0504.735	Nr. 2	0501.010	Nr. 2	0840.010	Nr. 2
0504.950	Nr. 2	0504.118	Nr. 2	0841.010	Nr. 2
0490.030	Nr. 6	0504.124	Nr. 2	0807.010	Nr. 1
0490.024	Nr. 6	0593.910	Nr. 2	0815.010	Nr. 1
0490.018	Nr. 6	1051.247	Nr. 2	1548.010	Nr. 2
0491.024	Nr. 6	1051.224	Nr. 2	0064.010	Nr. 2

Dimensione-dimension: mm 1000 x 450 x h. 2050

0014.010 143 PZ. **4.226,10**





edilizia building

0015 Espositore 280 utensili - **EDILIZIA**
 Display stand 280 tools - **BUILDING**

Contenuto - content:			
0062.010	Nr. 2	0404.020	Nr. 6
0066.010	Pz. 102	0420.022	Nr. 6
0094.010	Nr. 2	0420.025	Nr. 6
0347.090	Nr. 6	0420.028	Nr. 6
0382.925	Nr. 6	0417.020	Nr. 6
0382.930	Nr. 6	0417.022	Nr. 6
0382.940	Nr. 6	0417.025	Nr. 6
0383.908	Nr. 6	0503.041	Nr. 2
0383.910	Nr. 6	0560.025	Nr. 2
0383.912	Nr. 6	0563.010	Nr. 6
0402.045	Nr. 1	0635.010	Pz. 48
0402.060	Nr. 1	0683.010	Nr. 12
0402.075	Nr. 1	0792.042	Nr. 2
1023.080	Nr. 2		
1033.080	Nr. 2		
1052.212	Nr. 6		
1053.212	Nr. 2		

Dimensione-dimension: mm 1000 x 450 x h. 2050

0015.010 280 PZ. **2.800,80**

autoattrezzature automotive

0016 Esp. 357 utens. - **AUTOATTEZZATURE**
 Disp. stand 357 tools - **AUTOMOTIVE**

Contenuto - content:			
0066.010	Nr. 1	1334.272	Nr. 1
0512.110	Nr. 1	1383.010	Nr. 2
1064.015	Nr. 1	1702.100	Nr. 1
1570.015	Nr. 1	1702.200	Nr. 1
1150.080	Nr. 1	1360.011	Nr. 1
1150.100	Nr. 1	1360.015	Nr. 2
1150.130	Nr. 1	1362.015	Nr. 2
1150.170	Nr. 1	1363.015	Nr. 1
1150.190	Nr. 1	1364.010	Nr. 1
1152.030	Nr. 1	1386.010	Nr. 2
1152.040	Nr. 1	1388.038	Nr. 2
1152.050	Nr. 1	1388.055	Nr. 2
1155.005	Nr. 2	1723.001	Nr. 1
1155.020	Nr. 2	1723.002	Nr. 1
1336.179	Nr. 1		

Dimensione-dimension: mm 1000 x 450 x h. 2050

0016.015 357 PZ. **3.779,20**





elettrico electric

0017 Espositore 341 utensili - **ELETRICO**
 Display stand 341 tools - **ELECTRIC**

Contenuto - content:

0066.010	Pz. 102	0525.010	Nr. 6	0750.010	Nr. 2
0094.010	Nr. 3	0526.010	Nr. 6	0751.010	Nr. 2
0095.010	Nr. 3	0527.010	Nr. 6	0752.010	Nr. 2
0096.010	Pz. 101	0680.010	Nr. 12	0756.010	Nr. 2
0377.030	Nr. 6	0683.010	Nr. 12		
0383.908	Nr. 6	0686.110	Nr. 12		
0520.010	Nr. 6	0728.010	Pz. 36		
0522.010	Nr. 6	0700.010	Nr. 2		
0524.010	Nr. 6	0741.020	Nr. 2		

Dimensione-dimension: mm 1000 x 450 x h. 2050

0017.010 341 PZ. **3.548,40**

giraviti screwdrivers

0070 Espositore 477 giraviti - **metallo**
 Display stand 477 screwdrivers - **metal**

Dimensione-dimension: mm 500 x 777 x h. 2000

0070.010 477 PZ. **2.779,35**

50



libero servizio self-service

0024.010 Esp. 634 utensili - **SELF-SERVICE**
 Disp. stand 634 tools - **SELF-SERVICE**

Contenuto - content:

0050.307-9	Nr. 12	0344.040-9	Nr. 6	1030.060-9	Nr. 12	1500.080-9	Nr. 6
0050.410-9	Nr. 12	0344.050-9	Nr. 6	1030.070-9	Nr. 12	1500.090-9	Nr. 6
0050.512-9	Nr. 12	0377.020-9	Nr. 6	1030.080-9	Nr. 12	1500.100-9	Nr. 6
0050.612-9	Nr. 12	0377.030-9	Nr. 6	1030.090-9	Nr. 12	1500.110-9	Nr. 6
0050.615-9	Nr. 6	0412.916-9	Nr. 6	1030.100-9	Nr. 12	1500.120-9	Nr. 6
0050.815-9	Nr. 6	0417.022-9	Nr. 6	1030.110-9	Nr. 12	1500.130-9	Nr. 6
0052.010-9	Nr. 12	0440.918-9	Nr. 6	1030.120-9	Nr. 12	1500.140-9	Nr. 6
0052.108-9	Nr. 12	0440.920-9	Nr. 6	1030.130-9	Nr. 12	1500.150-9	Nr. 6
0052.210-9	Nr. 12	0463.916-9	Nr. 6	1030.140-9	Nr. 12	1500.160-9	Nr. 6
0052.315-9	Nr. 6	0466.916-9	Nr. 6	1030.150-9	Nr. 12	1500.170-9	Nr. 6
0053.108-9	Nr. 12	0474.025-9	Nr. 2	1030.160-9	Nr. 12	1500.180-9	Nr. 6
0053.210-9	Nr. 12	0490.024-9	Nr. 6	1030.170-9	Nr. 12	1500.190-9	Nr. 6
0075.100-9	Nr. 6	0680.010	Nr. 12	1030.180-9	Nr. 6	1500.210-9	Nr. 6
0075.150-9	Nr. 6	0347.090	Nr. 6	1030.190-9	Nr. 6	1500.220-9	Nr. 6
0075.200-9	Nr. 6	0366.090	Nr. 6	1030.200-9	Nr. 6	1505.010-9	Nr. 2
0075.250-9	Nr. 6	1020.067-9	Nr. 12	1030.210-9	Nr. 6	1508.125-9	Nr. 4
0090.310-9	Nr. 6	1020.089-9	Nr. 12	1030.220-9	Nr. 6	1510.010-9	Nr. 6
0090.410-9	Nr. 6	1020.101-9	Nr. 12	1033.080	Nr. 2	1512.010-9	Nr. 6
0092.110-9	Nr. 6	1020.123-9	Nr. 12	1067.080-9	Nr. 6	0062.010	Nr. 2
0344.025-9	Nr. 6	1020.145-9	Nr. 12	1067.100-9	Nr. 6	1548.010	Nr. 2
0344.030-9	Nr. 6	1023.080	Nr. 2	1067.130-9	Nr. 6		

Dimensione-dimension: mm 1000 x 450 x h. 2050

0024.010 634 PZ. **4.135,40**



- confezioni appendibili personalizzate per categorie di utensili
hanged special packaging for each tools range
- ingombro ridotto della confezione appendibile
smaller hanged packaging
- valorizzazione dell'utensile
make the most of tools
- per prodotto confezionato self-service aggiungere al codice "-9"
(es: 1030.130 - 9). Vedi pagina 209.
for products in self-service packing add to code "-9" (ex. 1030.130-9).
See page 209.





libero servizio self-service

0025.030 Esp. 1116 utensili - **SELF-SERVICE**
 Disp. stand 1116 tools - **SELF-SERVICE**

Contenuto - content:

0344.320-9	Nr. 6	1020.202-9	Nr. 6	1055.100-9	Nr. 6	1500.140-9	Nr. 6	0051.415-9	Nr. 12	0090.615-9	Nr. 6	0490.018-9	Nr. 6
0344.325-9	Nr. 6	1023.080	Nr. 2	1055.130-9	Nr. 6	1500.150-9	Nr. 6	0051.515-9	Nr. 12	0092.007-9	Nr. 6	0490.024-9	Nr. 6
0344.330-9	Nr. 6	1030.060-9	Nr. 12	1055.170-9	Nr. 6	1500.160-9	Nr. 6	0052.010-9	Nr. 12	0092.110-9	Nr. 6	0490.030-9	Nr. 6
0344.340-9	Nr. 6	1030.070-9	Nr. 12	1055.190-9	Nr. 6	1500.170-9	Nr. 6	0052.108-9	Nr. 12	0092.210-9	Nr. 6	0505.018-9	Nr. 6
0344.350-9	Nr. 6	1030.080-9	Nr. 12	1092.067-9	Nr. 6	1500.180-9	Nr. 6	0052.112-9	Nr. 12	0094.010	Nr. 1	0506.017-9	Nr. 6
0344.360-9	Nr. 6	1030.090-9	Nr. 12	1092.089-9	Nr. 6	1500.190-9	Nr. 6	0052.210-9	Nr. 12	0344.020-9	Nr. 6	0510.018-9	Nr. 6
0347.090	Nr. 6	1030.100-9	Nr. 12	1092.101-9	Nr. 6	1500.210-9	Nr. 6	0052.215-9	Nr. 6	0344.025-9	Nr. 6	0511.017-9	Nr. 6
0366.090	Nr. 6	1030.120-9	Nr. 12	1092.123-9	Nr. 6	1500.220-9	Nr. 6	0052.315-9	Nr. 6	0344.030-9	Nr. 6	0560.025-9	Nr. 2
0351.090	Nr. 6	1030.110-9	Nr. 12	1092.145-9	Nr. 6	1500.240-9	Nr. 6	0053.108-9	Nr. 12	0344.040-9	Nr. 6	0580.060-9	Nr. 6
0502.032-9	Nr. 2	1030.130-9	Nr. 12	1092.167-9	Nr. 6	1500.270-9	Nr. 6	0053.210-9	Nr. 12	0344.050-9	Nr. 6	0580.100-9	Nr. 6
0503.030-9	Nr. 2	1030.140-9	Nr. 12	1098.080-9	Nr. 6	1500.300-9	Nr. 6	0055.603-9	Nr. 12	0370.035	Nr. 4	0580.140-9	Nr. 6
0503.041-9	Nr. 2	1030.150-9	Nr. 12	1098.100-9	Nr. 6	1500.320-9	Nr. 6	0056.103-9	Nr. 12	0372.030	Nr. 4	0580.180-9	Nr. 6
0504.030-9	Nr. 2	1030.160-9	Nr. 12	1098.130-9	Nr. 6	1505.010-9	Nr. 2	0058.430-9	Nr. 6	0377.020	Nr. 6	0680.010	Nr. 12
0504.045-9	Nr. 1	1030.170-9	Nr. 12	1098.170-9	Nr. 6	1508.125-9	Nr. 4	0059.130-9	Nr. 6	0377.030	Nr. 6	0683.010	Nr. 2
0770.022-9	Nr. 2	1030.180-9	Nr. 6	1098.190-9	Nr. 6	1508.250-9	Nr. 4	0062.010	Nr. 2	0404.020-9	Nr. 6	1070.015-9	Nr. 2
0774.032-9	Nr. 2	1030.190-9	Nr. 6	1150.080-9	Nr. 6	1510.010-9	Nr. 6	0064.010	Nr. 2	0412.916-9	Nr. 6	1070.020-9	Nr. 2
0790.042-9	Nr. 2	1030.200-9	Nr. 6	1150.100-9	Nr. 6	1512.010-9	Nr. 6	0075.060-9	Nr. 6	0417.022-9	Nr. 6	1070.025-9	Nr. 2
0792.042-9	Nr. 2	1030.210-9	Nr. 6	1150.130-9	Nr. 2	1527.160-9	Nr. 6	0075.100-9	Nr. 6	0417.025-9	Nr. 6	1442.010	Nr. 1
1020.067-9	Nr. 12	1030.220-9	Nr. 6	1150.170-9	Nr. 6	0050.307-9	Nr. 12	0075.150-9	Nr. 6	0425.020-9	Nr. 6	1548.010	Nr. 1
1020.089-9	Nr. 12	1030.240-9	Nr. 6	1500.080-9	Nr. 6	0050.410-9	Nr. 12	0075.200-9	Nr. 6	0440.918-9	Nr. 6		
1020.101-9	Nr. 12	1030.270-9	Nr. 6	1500.090-9	Nr. 6	0050.512-9	Nr. 12	0075.250-9	Nr. 6	0440.920-9	Nr. 6		
1020.123-9	Nr. 12	1030.300-9	Nr. 6	1500.100-9	Nr. 6	0050.612-9	Nr. 12	0075.300-9	Nr. 6	0463.916-9	Nr. 6		
1020.145-9	Nr. 12	1033.080	Nr. 2	1500.110-9	Nr. 6	0050.615-9	Nr. 6	0090.310-9	Nr. 6	0466.916-9	Nr. 6		
1020.167-9	Nr. 12	1033.120	Nr. 2	1500.120-9	Nr. 6	0050.815-9	Nr. 6	0090.410-9	Nr. 6	0467.916-9	Nr. 6		
1020.189-9	Nr. 6	1055.080-9	Nr. 6	1500.130-9	Nr. 6	0051.310-9	Nr. 12	0090.512-9	Nr. 6	0474.025-9	Nr. 2		

Dimensione-dimension: mm 2000 x 450 x h. 2050

0025.030

1116 PZ.

9.509,90



50

GIRAVITE PER VITI INTAGLIO-MECCANICI - acciaio chrom-vanadium-molibdeno finitura cromata punta nera
SCREWDRIVER FOR SLOTTED HEAD SCREWS-MECHANIC - chrom-vanadium-molybdenum steel chrome plated black finish tip

Pro
INDUSTRIAL

Cr-Mo
ACCIAIO CHROM-VANADIUM-MOLIBDENO

acciaio chrom-molybdenum durezza HRC 60
 chrom-molybdenum steel hardness HRC 60

sezione cilindrica per rotazione rapida
 cylindrical section for fast rotation

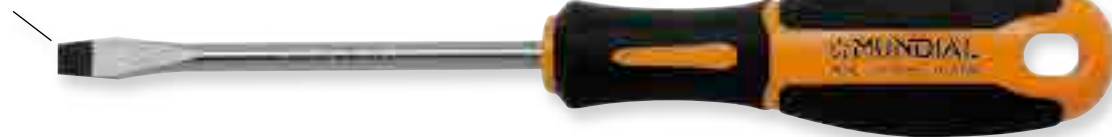

profilo triangolare per trasmissione sforzo
 triangle section for force transmission

DIN 5265 ISO 2380 HRC 60 Chrom-Vanadium-Molibdeno

Icona	ISO	ISO	ISO	ISO	ISO	ISO	ISO	ISO	ISO	ISO	€
0050.307	3,0 x 0,5 x 75	87,5 x 25,4	30	12	8011578950002	2,60					
0050.310	3,0 x 0,5 x 100	87,5 x 25,4	32	12	8011578950033	2,85					
0050.410	4,0 x 0,8 x 100	109 x 31,7	64	12	8011578950095	3,80					
0050.412	4,0 x 0,8 x 125	109 x 31,7	64	12	8011578950125	4,05					
0050.510	5,5 x 1,0 x 100	109 x 31,7	72	12	8011578950156	4,10					
0050.512	5,5 x 1,0 x 125	109 x 31,7	74	12	8011578950187	4,25					
0050.515	5,5 x 1,0 x 150	109 x 31,7	78	12	8011578950217	4,40					
0050.610	6,5 x 1,2 x 100	117 x 34,0	86	12	8011578950248	5,20					
0050.612	6,5 x 1,2 x 125	117 x 34,0	94	12	8011578950279	5,50					
0050.615	6,5 x 1,2 x 150	117 x 34,0	98	6	8011578950309	5,85					
0050.815	8,0 x 1,2 x 150	127 x 36,9	125	6	8011578950330	7,70					
0050.820	8,0 x 1,2 x 200	127 x 36,9	164	6	8011578950361	8,55					
0050.920	10,0 x 1,6 x 200	127 x 36,9	200	6	8011578950378	11,25					

COMOGrip
MUNDIAL

51

GIRAVITE PER VITI INTAGLIO-LAME PARALLELE - acciaio chrom-vanadium-molibdeno finitura cromata punta nera
SCREWDRIVER FOR SLOTTED HEAD SCREWS-CABINET - chrom-vanadium-molybdenum steel chrome plated black finish tip

DIN 5265 ISO 2380 HRC 60

Icona	ISO	ISO	ISO	ISO	ISO	ISO	ISO	ISO	ISO	ISO	€
0051.256	2,5 x 0,4 x 60	87,5 x 25,4	28	12	8011578950392	3,15					
0051.310	3,0 x 0,5 x 100	87,5 x 25,4	32	12	8011578950422	3,50					
0051.412	4,0 x 0,8 x 125	109 x 31,7	64	12	8011578950453	4,00					
0051.415	4,0 x 0,8 x 150	109 x 31,7	62	12	8011578950484	4,40					
0051.515	5,0 x 1,0 x 150	109 x 31,7	72	12	8011578950545	4,65					



Pro
INDUSTRIAL

Cr-Mo
ACCIAIO CHROM-VANADIUM-MOLIBDENO

52

GIRAVITE PER VITI CROCE PHILLIPS - acciaio chrom-vanadium-molibdeno finitura cromata punta nera
SCREWDRIVER FOR PHILLIPS CROSS HEAD SCREWS - chrom-vanadium-molybdenum steel chrome plated black finish tip

DIN 5262 ISO 8764 HRC 60

Icona	ISO	ISO	ISO	ISO	ISO	ISO	ISO	ISO	ISO	ISO	€
0052.006	PH 0 x 60 x 3,0	87,5 x 25,4	30	12	8011578950606	2,60					
0052.010	PH 0 x 100 x 3,0	87,5 x 25,4	34	12	8011578950637	2,85					
0052.108	PH 1 x 80 x 4,5	109 x 31,7	68	12	8011578950668	3,75					
0052.112	PH 1 x 125 x 4,5	109 x 31,7	76	12	8011578950699	4,35					
0052.210	PH 2 x 100 x 6,0	117 x 34,0	92	12	8011578950729	5,10					
0052.215	PH 2 x 150 x 6,0	117 x 34,0	98	6	8011578950750	5,95					
0052.315	PH 3 x 150 x 8,0	127 x 36,9	146	6	8011578950781	7,70					



Pro
INDUSTRIAL

Cr-Mo
ACCIAIO CHROM-VANADIUM-MOLIBDENO

53

GIRAVITE PER VITI CROCE POZIDRIV - acciaio chrom-vanadium-molibdeno finitura cromata punta nera
SCREWDRIVER FOR POZIDRIV CROSS HEAD SCREWS - chrom-vanadium-molybdenum steel chrome plated black finish tip

DIN 5262 ISO 8764 HRC 60

Icona	ISO	ISO	ISO	ISO	ISO	ISO	ISO	ISO	ISO	ISO	€
0053.006	PZ 0 x 60 x 3,0	87,5 x 25,4	30	12	8011578950811	2,70					
0053.108	PZ 1 x 80 x 4,5	109 x 31,7	66	12	8011578950842	3,85					
0053.112	PZ 1 x 125 x 4,5	109 x 31,7	72	12	8011578950873	4,45					
0053.210	PZ 2 x 100 x 6,0	117 x 34,0	88	12	8011578950903	5,60					
0053.215	PZ 2 x 150 x 6,0	117 x 34,0	102	6	8011578950934	6,05					
0053.315	PZ 3 x 150 x 8,0	127 x 36,9	148	6	8011578950965	7,90					



Pro
INDUSTRIAL

Cr-Mo
ACCIAIO CHROM-VANADIUM-MOLIBDENO

55
GIRAVITE PER VITI INTAGLIO-MECCANICI - acciaio chrom-vanadium-molibdeno finitura cromata punta nera
SCREWDRIVER FOR SLOTTED HEAD SCREWS-MECHANIC - chrom-vanadium-molybdenum steel chrome plated black finish tip

DIN 5265 ISO 2380

Icon	Model	Size	Length	Weight	Material	Barcode	Price
	0055.403	5,0 x 0,8 x 38	55 x 32	34	12	8011578950996	3,65
	0055.603	6,5 x 1,0 x 38	55 x 32	36	12	8011578951023	3,75

**56**
GIRAVITE PER VITI CROCE PHILLIPS - acciaio chrom-vanadium-molibdeno finitura cromata punta nera
SCREWDRIVER FOR PHILLIPS CROSS HEAD SCREWS - chrom-vanadium-molybdenum steel chrome plated black finish tip

DIN 5262 ISO 8764

Icon	Model	Size	Length	Weight	Material	Barcode	Price
	0056.103	PH 1 x 38 x 4,5	55 x 32	34	12	8011578951054	3,65
	0056.203	PH 2 x 38 x 6,0	55 x 32	36	12	8011578951085	3,75

**57**
GIRAVITE PER VITI CROCE POZIDRIV - acciaio chrom-vanadium-molibdeno finitura cromata punta nera
SCREWDRIVER FOR POZIDRIV CROSS HEAD SCREWS - chrom-vanadium-molybdenum steel chrome plated black finish tip

DIN 5262 ISO 8764

Icon	Model	Size	Length	Weight	Material	Barcode	Price
	0057.103	PZ 1 x 38 x 4,5	55 x 32	34	12	8011578951115	3,75
	0057.203	PZ 2 x 38 x 6,0	55 x 32	36	12	8011578951146	3,85

**58**
GIRAVITE PER VITI INTAGLIO-LAME PARALLELE - acciaio chrom-vanadium-molibdeno finitura cromata punta nera
SCREWDRIVER FOR SLOTTED HEAD SCREWS-CABINET - chrom-vanadium-molybdenum steel chrome plated black finish tip

mm 300 - 400

Icon	Model	Size	Length	Weight	Material	Barcode	Price
	0058.330	3,0 x 0,5 x 300	87,5 x 25,4	42	6	8011578951177	5,35
	0058.430	4,0 x 0,8 x 300	109 x 31,7	80	6	8011578951207	6,25
	0058.440	4,0 x 0,8 x 400	109 x 31,7	85	6	8011578963286	7,30
	0058.530	5,0 x 0,8 x 300	109 x 31,7	96	6	8011578951238	7,05
	0058.630	6,0 x 1,0 x 300	117 x 34,0	130	6	8011578951269	9,30
	0058.640	6,0 x 1,0 x 400	117 x 34,0	135	6	8011578963309	10,10

**59**
GIRAVITE PER VITI CROCE PHILLIPS - acciaio chrom-vanadium-molibdeno finitura cromata punta nera
SCREWDRIVER FOR PHILLIPS CROSS HEAD SCREWS - chrom-vanadium-molybdenum steel chrome plated black finish tip

Icon	Model	Size	Length	Weight	Material	Barcode	Price
	0059.030	PH 0 x 300 x 3,0	87,5 x 25,4	42	6	8011578951290	4,75
	0059.130	PH 1 x 300 x 4,5	109 x 31,7	98	6	8011578951320	6,85
	0059.140	PH 1 x 400 x 4,5	109 x 31,7	102	6	8011578963323	7,10
	0059.230	PH 2 x 300 x 6,0	117 x 34,0	130	6	8011578951351	9,30
	0059.240	PH 2 x 400 x 6,0	117 x 34,0	134	6	8011578963347	10,25



62

SERIE 5 GIRAVITI intaglio - croce PH - cartone
SET 5 SCREWDRIVERS slotted - cross PH - box

Pro
INDUSTRIAL

Cr-Mo
ACQUADRENATI
CROMIUMVANADIUM
MULTICENTRO



Contenuto-content:

- 0050.307 3,0 x 0,5 x 75
- 0050.410 4,0 x 0,8 x 100
- 0050.612 6,5 x 1,2 x 125
- 0052.108 PH 1 x 80 - 4,5
- 0052.210 PH 2 x 100 - 6

 **0062.010**  310 x 180 x 37

 490

 8011578 000004
8011578956356

€ **23,30**



63

SERIE 5 GIRAVITI intaglio - croce PZ - cartone
SET 5 SCREWDRIVERS slotted - cross PZ - box

Pro
INDUSTRIAL

Cr-Mo
ACQUADRENATI
CROMIUMVANADIUM
MULTICENTRO



Contenuto-content:

- 0050.307 3,0 x 0,5 x 75
- 0050.410 4,0 x 0,8 x 100
- 0050.612 6,5 x 1,2 x 125
- 0053.108 PZ 1 x 80 - 4,5
- 0053.210 PZ 2 x 100 - 6

 **0063.010**  310 x 180 x 37

 484

 8011578 000004
8011578956387

€ **23,90**



64

SERIE 7 GIRAVITI intaglio - croce PH - cartone
SET 7 SCREWDRIVERS slotted - cross PH - box

Pro
INDUSTRIAL

Cr-Mo
ACQUADRENATI
CROMIUMVANADIUM
MULTICENTRO



Contenuto-content:

- 0050.307 3,0 x 0,5 x 75
- 0050.410 4,0 x 0,8 x 100
- 0050.510 5,5 x 1,0 x 100
- 0050.612 6,5 x 1,2 x 125
- 0052.006 PH 0 x 60 - 3
- 0052.108 PH 1 x 80 - 4,5
- 0052.210 PH 2 x 100 - 6

 **0064.010**  330 x 220 x 40

 636

 8011578 000004
8011578956417

€ **31,05**



66
ESPOSITORE 102 GIRAVITI - metallo
 DISPLAY STAND 102 SCREWDRIVERS - metal

Contenuto-content:

0050.307	3,0 x 0,5 x 75	Nr. 9
0050.410	4,0 x 0,8 x 100	Nr. 8
0050.512	5,5 x 1,0 x 125	Nr. 8
0050.612	6,5 x 1,2 x 125	Nr. 7
0050.815	8,0 x 1,2 x 150	Nr. 6
0051.310	3,0 x 0,5 x 100	Nr. 9
0051.415	4,0 x 0,8 x 150	Nr. 8
0051.515	5,0 x 1,0 x 150	Nr. 8
0052.010	PH 0 x 100 - 3	Nr. 9
0052.108	PH 1 x 80 - 4,5	Nr. 8
0052.210	PH 2 x 100 - 6	Nr. 7
0053.108	PZ 1 x 80 - 5	Nr. 8
0053.210	PZ 2 x 100 - 6	Nr. 7

 0066.010 495 x 280 x h 450
 0066.210 vuoto - empty



 14000
 6800

 80115781000004
 8011578956448
 8011578949143



 437,75
 70,00
**68**
ESPOSITORE 159 GIRAVITI - metallo
 DISPLAY STAND 159 SCREWDRIVERS - metal

Contenuto-content:

0050.307	3,0 x 0,5 x 75	Nr. 9
0050.410	4,0 x 0,8 x 100	Nr. 8
0050.512	5,5 x 1,0 x 125	Nr. 8
0050.612	6,5 x 1,2 x 125	Nr. 7
0050.615	6,5 x 1,2 x 150	Nr. 7
0050.815	8,0 x 1,2 x 150	Nr. 6
0051.310	3,0 x 0,5 x 100	Nr. 9
0051.415	4,0 x 0,8 x 150	Nr. 8
0051.515	5,0 x 1,0 x 150	Nr. 8
0052.010	PH 0 x 100 - 3	Nr. 9
0052.108	PH 1 x 80 - 4,5	Nr. 8
0052.112	PH 1 x 125 - 4,5	Nr. 8
0052.210	PH 2 x 100 - 6	Nr. 7
0052.215	PH 2 x 150 - 6	Nr. 7
0052.315	PH 3 x 150 - 8	Nr. 6
0053.006	PZ 0 x 60 - 3	Nr. 9
0053.108	PZ 1 x 80 - 5	Nr. 8
0053.210	PZ 2 x 100 - 6	Nr. 7
0053.315	PZ 3 x 150 - 8	Nr. 6
0055.603	6,0 x 1,0 x 30 - 6	Nr. 7
0056.103	PH 1 x 30 - 4,5	Nr. 7

 0068.010 770 x 280 x h 450
 0068.210 vuoto - empty

 23500
 8700

 80115781000004
 8011578956479
 8011578949167

 724,85
 110,00

70

ESPOSITORE 477 GIRAVITI - metallo
DISPLAY STAND 477 SCREWDRIVERS - metal



Contenuto-content:

0050.307	3,0 x 0,5 x 75	Nr. 9
0050.410	4,0 x 0,8 x 100	Nr. 8
0050.412	4,0 x 0,8 x 125	Nr. 8
0050.512	5,5 x 1,0 x 125	Nr. 8
0050.612	6,5 x 1,2 x 125	Nr. 7
0050.615	6,5 x 1,2 x 150	Nr. 7
0050.815	8,0 x 1,2 x 150	Nr. 6
0051.256	2,5 x 0,4 x 60	Nr. 9
0051.310	3,0 x 0,5 x 100	Nr. 9
0051.415	4,0 x 0,8 x 150	Nr. 8
0051.515	5,0 x 1,0 x 150	Nr. 8
0055.403	5,0 x 0,8 x 38	Nr. 7
0055.603	6,5 x 1,0 x 38	Nr. 7

0052.010	PH 0 x 100 - 3	Nr. 9
0052.108	PH 1 x 80 - 4,5	Nr. 8
0052.112	PH 1 x 125 - 4,5	Nr. 8
0052.210	PH 2 x 100 - 6	Nr. 7
0052.215	PH 2 x 150 - 6	Nr. 7
0052.315	PH 3 x 150 - 8	Nr. 6
0053.006	PZ 0 x 60 - 3	Nr. 9
0053.108	PZ 1 x 80 - 5	Nr. 8
0053.210	PZ 2 x 100 - 6	Nr. 7
0053.315	PZ 3 x 150 - 8	Nr. 6
0056.103	PH 1 x 38 - 4,5	Nr. 7
0056.203	PH 2 x 38 - 6	Nr. 7
0057.103	PZ 1 x 38 - 4,5	Nr. 7

0075.060	TX 6 x 60	Nr. 9
0075.070	TX 7 x 60	Nr. 9
0075.080	TX 8 x 60	Nr. 9
0075.090	TX 9 x 60	Nr. 9
0075.100	TX 10 x 80	Nr. 8
0075.150	TX 15 x 80	Nr. 8
0075.200	TX 20 x 100	Nr. 8
0075.250	TX 25 x 100	Nr. 8
0075.270	TX 27 x 100	Nr. 8
0075.300	TX 30 x 100	Nr. 7
0075.400	TX 40 x 125	Nr. 6
0075.450	TX 45 x 125	Nr. 6
0084.010	1/4" x 100	Nr. 6

0090.258	2,5 x 0,4 x 80	Nr. 9
0090.310	3,0 x 0,5 x 100	Nr. 9
0090.410	4,0 x 0,8 x 100	Nr. 8
0090.512	5,5 x 1,0 x 125	Nr. 8
0090.615	6,5 x 1,2 x 150	Nr. 7
0090.817	8,0 x 1,6 x 175	Nr. 6
0092.007	PH 0 x 75	Nr. 9
0092.110	PH 1 x 100	Nr. 8
0092.210	PH 2 x 100	Nr. 7
0092.315	PH 3 x 150	Nr. 6
0093.007	PZ 0 x 75	Nr. 9
0093.110	PZ 1 x 100	Nr. 8
0093.210	PZ 2 x 100	Nr. 7

0082.050	5	Nr. 6
0082.055	5,5	Nr. 6
0082.060	6	Nr. 6
0082.070	7	Nr. 6
0082.080	8	Nr. 6
0082.090	9	Nr. 6
0082.100	10	Nr. 6
0082.110	11	Nr. 6
0082.120	12	Nr. 6
0082.130	13	Nr. 6
0082.140	14	Nr. 6
0058.430	4,0 x 0,8 x 300	Nr. 6
0059.130	PH 1 x 300 - 5	Nr. 6



	— L —	
0070.010	500 x 500 x 2000	68900
0070.210	vuoto - empty	30300















8011578956509	2.779,35
8011578949181	260,00

€

72
GIRAVITE PER VITI TORX - acciaio chrom-vanadium-molibdeno finitura cromata punta nera
SCREWDRIVER FOR TORX HEAD SCREWS - chrom-vanadium-molybdenum steel chrome plated black finish tip

HRC 60

Icona	Modello	Dimensioni	Spessore	Materiali	Quantità	Barcode	Prezzo
	0072.060	TX 6 x 60	87,5 x 25,4	28	6	8011578951382	3,30
	0072.070	TX 7 x 60	87,5 x 25,4	28	6	8011578951412	3,30
	0072.080	TX 8 x 80	87,5 x 25,4	28	6	8011578951443	3,30
	0072.090	TX 9 x 80	87,5 x 25,4	54	6	8011578951474	4,10
	0072.100	TX 10 x 80	109 x 31,7	56	6	8011578951504	4,20
	0072.150	TX 15 x 80	109 x 31,7	56	6	8011578951535	4,20
	0072.200	TX 20 x 100	109 x 31,7	60	6	8011578951566	4,40
	0072.250	TX 25 x 100	109 x 31,7	66	6	8011578951597	4,60
	0072.270	TX 27 x 100	109 x 31,7	66	6	8011578951627	4,60
	0072.300	TX 30 x 100	117 x 34,0	86	6	8011578951658	6,15
	0072.400	TX 40 x 125	127 x 36,9	136	6	8011578951689	8,35
	0072.450	TX 45 x 125	127 x 36,9	136	6	8011578951719	8,35

**73**
SERIE 5 GIRAVITI TORX - cartone
SET 5 TORX SCREWDRIVERS - box

Contenuto-content:

0072.100 TX 10 x 80
 0072.150 TX 15 x 80
 0072.200 TX 20 x 100
 0072.250 TX 25 x 100
 0072.300 TX 30 x 100

Icona	Dimensioni	Spessore	Barcode	Prezzo
	0073.010	310 x 180 x 37	8011578956530	26,10

**73**
SERIE 7 GIRAVITI TORX - cartone
SET 7 TORX SCREWDRIVERS - box

Contenuto-content:

0072.060 TX 6 x 60
 0072.080 TX 8 x 80
 0072.100 TX 10 x 80
 0072.150 TX 15 x 80
 0072.200 TX 20 x 100
 0072.250 TX 25 x 100
 0072.300 TX 30 x 100

Icona	Dimensioni	Spessore	Barcode	Prezzo
	0073.020	330 x 220 x 40	8011578980054	33,75 new

**74**
ESPOSITORE 101 GIRAVITI TORX - metallo
DISPLAY STAND 101 TORX SCREWDRIVERS - metal

Contenuto-content:

0072.060	TX 6 x 60	Nr. 9	0072.250	TX 25 x 100	Nr. 8
0072.070	TX 7 x 60	Nr. 9	0072.270	TX 27 x 100	Nr. 8
0072.080	TX 8 x 60	Nr. 9	0072.300	TX 30 x 100	Nr. 7
0072.090	TX 9 x 60	Nr. 9	0072.400	TX 40 x 125	Nr. 6
0072.100	TX 10 x 80	Nr. 8	0072.450	TX 45 x 125	Nr. 6
0072.150	TX 15 x 80	Nr. 8	0084.010	1/4" x 100	Nr. 6
0072.200	TX 20 x 100	Nr. 8			





Icona	Dimensioni	Spessore	Barcode	Prezzo
	0074.010	500 x 280 x 450	8011578956561	482,75
	0074.210	vuoto - empty	8011578949204	70,00



75

GIRAVITE PER VITI TORX CON FORO - acciaio chrom-vanadium-molibdeno finitura cromata punta nera
SCREWDRIVER FOR TORX WITH HOLE HEAD SCREWS - chrom-vanadium-molybdenum steel chrome plated black finish tip

HRC 60

Icona	Modello	Dimensione	Lunghezza	Spessore	Quantità	Barcode	Prezzo
		X				011578 000004	€
	0075.060	TX 6 x 60	87,5 x 25,4	28	6	8011578951740	3,70
	0075.070	TX 7 x 60	87,5 x 25,4	28	6	8011578951771	3,70
	0075.080	TX 8 x 80	87,5 x 25,4	30	6	8011578951801	3,70
	0075.090	TX 9 x 80	109 x 31,7	56	6	8011578951832	4,35
	0075.100	TX 10 x 80	109 x 31,7	58	6	8011578951863	4,45
	0075.150	TX 15 x 80	109 x 31,7	60	6	8011578951894	4,45
	0075.200	TX 20 x 100	109 x 31,7	62	6	8011578951924	4,60
	0075.250	TX 25 x 100	109 x 31,7	70	6	8011578951955	4,95
	0075.270	TX 27 x 100	109 x 31,7	66	6	8011578951986	4,95
	0075.300	TX 30 x 100	117 x 34,0	88	6	8011578952013	6,50
	0075.400	TX 40 x 125	127 x 36,9	138	6	8011578952044	8,80
	0075.450	TX 45 x 125	127 x 36,9	138	6	8011578952075	8,80



76

SERIE 5 GIRAVITI TORX CON FORO - cartone
SET 5 TORX SCREWDRIVERS WITH HOLE - box



Contenuto-content:

- 0075.100 TX 10 x 80
- 0075.150 TX 15 x 80
- 0075.200 TX 20 x 100
- 0075.250 TX 25 x 100
- 0075.300 TX 30 x 100

Icona	Dimensione	Spessore	Quantità	Barcode	Prezzo
	L-L			011578 000004	€
	0076.010	310 x 180 x 37	476	8011578956592	27,50 new



76

SERIE 7 GIRAVITI TORX CON FORO - cartone
SET 7 TORX SCREWDRIVERS WITH HOLE - box



Contenuto-content:

- 0075.060 TX 6 x 60
- 0075.080 TX 8 x 80
- 0075.100 TX 10 x 80
- 0075.150 TX 15 x 80
- 0075.200 TX 20 x 100
- 0075.250 TX 25 x 100
- 0075.300 TX 30 x 100

Icona	Dimensione	Spessore	Quantità	Barcode	Prezzo
	L-L			011578 000004	€
	0076.020	330 x 220 x 40	630	8011578983567	35,95 new



77

ESP. 101 GIRAVITI TORX CON FORO - metallo
DISP. STAND 101 TORX SCREWDRIVERS WITH HOLE - metal

Contenuto-content:

0075.060	TX 6 x 60	Nr. 9	0075.250	TX 25 x 100	Nr. 8
0075.070	TX 7 x 60	Nr. 9	0075.270	TX 27 x 100	Nr. 8
0075.080	TX 8 x 60	Nr. 9	0075.300	TX 30 x 100	Nr. 7
0075.090	TX 9 x 60	Nr. 9	0075.400	TX 40 x 125	Nr. 6
0075.100	TX 10 x 80	Nr. 8	0075.450	TX 45 x 125	Nr. 6
0075.150	TX 15 x 80	Nr. 8	0084.010	1/4" x 100	Nr. 6
0075.200	TX 20 x 100	Nr. 8			

Icona	Dimensione	Spessore	Quantità	Barcode	Prezzo
	L-L			011578 000004	€
	0077.010	500 x 280 x 450	13000	8011578956622	514,85
	0077.210	vuoto - empty	6800	8011578949228	70,00



78
CHIAVE MASCHIO ESAGONALE SFERICA - acciaio chrom-vanadium-molibdeno finitura cromata punta nera
SPHERICAL HEXAGONAL MALE WRENCH - chrom-vanadium-molybdenum steel chrome plated black finish tip

HRC 60

Icona	Modello	Dimensioni	Lunghezza	Spessore	Materiali	Quantità	Barcode	Prezzo
	0078.025	2,5 x 75	87,5 x 25,4	28	6	6	8011578952082	2,75
	0078.030	3,0 x 75	87,5 x 25,4	28	6	6	8011578952105	2,75
	0078.040	4,0 x 100	109 x 31,7	60	6	6	8011578952136	3,80
	0078.050	5,0 x 100	109 x 31,7	70	6	6	8011578952167	3,80
	0078.060	6,0 x 125	117 x 34,0	94	6	6	8011578952198	5,10

**80**
CHIAVE MASCHIO QUADRATA
SQUARE MALE WRENCH

HRC 60

Icona	Modello	Dimensioni	Lunghezza	Spessore	Materiali	Quantità	Barcode	Prezzo
	0080.100	SQ1 x 100 x 4	109 x 31,7	58	12	12	8011578952228	4,00
	0080.200	SQ2 x 125 x 5	109 x 31,7	70	12	12	8011578952259	5,05
	0080.300	SQ3 x 150 x 6	117 x 34,0	96	6	6	8011578952280	7,15

**82**
CHIAVE A BUSSOLA ESAGONO FORO PROFONDO
DEEP HOLE HEXAGON SOCKET

Icona	Modello	Dimensioni	Lunghezza	Spessore	Materiali	Quantità	Barcode	Prezzo
	0082.050	5,0 x 37 x 150	117 x 34	118	6	6	8011578952310	8,55
	0082.055	5,5 x 37 x 150	117 x 34	118	6	6	8011578952341	8,55
	0082.060	6,0 x 37 x 150	117 x 34	118	6	6	8011578952372	8,55
	0082.070	7,0 x 72 x 150	117 x 34	136	6	6	8011578952402	9,55
	0082.080	8,0 x 72 x 150	117 x 34	126	6	6	8011578952433	10,30
	0082.090	9,0 x 72 x 150	117 x 34	128	6	6	8011578952464	10,90
	0082.100	10,0 x 72 x 150	117 x 34	126	6	6	8011578952495	10,90
	0082.110	11,0 x 72 x 150	117 x 34	158	6	6	8011578952525	11,65
	0082.120	12,0 x 72 x 150	117 x 34	146	6	6	8011578952556	11,65
	0082.130	13,0 x 72 x 150	117 x 34	152	6	6	8011578952587	12,25
	0082.140	14,0 x 72 x 150	117 x 34	152	6	6	8011578952617	12,25

**83**
SERIE 5 CHIAVI BUSSOLA FORO PROFONDO - scatola
SET 5 DEEP HOLE SOCKETS - box

Contenuto-content:

0082.060	6	0082.100	10
0082.070	7	0082.130	13
0082.080	8		

Icona	Modello	Dimensioni	Spessore	Barcode	Prezzo
	0083.005	6 ÷ 13	1578	8011578980061	51,55



83

SERIE 10 CHIAVI BUSSOLA FORO PROFONDO - scatola
 SET 10 DEEP HOLE SOCKETS - box



Contenuto-content:

0082.050 0082.080 0082.120
 0082.055 0082.090 0082.130
 0082.060 0082.100
 0082.070 0082.110

    €

0083.010 5 ÷ 13 1578 8011578956653 **102,85**





83A

ESPOSITORE 78 CHIAVI BUSSOLA
 DISPLAY STAND 78 DEEP HOLE SOCKETS

Contenuto-content:

0082.050 5 x 37 Nr. 6 0082.110 11 x 72 Nr. 6
 0082.055 5,5 x 37 Nr. 6 0082.120 12 x 72 Nr. 6
 0082.060 6 x 37 Nr. 6 0082.130 13 x 72 Nr. 6
 0082.070 7 x 72 Nr. 6 0082.140 17 x 72 Nr. 6
 0082.080 8 x 72 Nr. 6 0084.010 1/4" x 100 Nr. 6
 0082.090 9 x 72 Nr. 6 0087.010 1/4" x 190 Nr. 6
 0082.100 10 x 72 Nr. 6

    €

0083.110 500 x 280 x 450 17220 8011578956684 **787,50**
0083.210 vuoto - empty 6800 8011578949242 **55,00**





84

PORTAINSERTI MAGNETICO ATTACCO 1/4"
 MAGNETIC BIT HOLDER 1/4"

1/4"

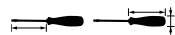

    €

0084.010 1/4" 100 117 x 34 100 **6** 8011578952648 **6,25**

con 6 bit / with 6 bits mm 4 - 5 - PH1 - PH2 - PZ1 - PZ2

0084.310 con 6 bit / with 6 bits 190 **2** 8011578985509 **9,65**





87

PORTAINSERTI FLESSIBILE ATTACCO 1/4"
 FLEXIBLE BIT HOLDER 1/4"

1/4"

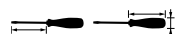

    €

0087.010 1/4" 190 117 x 34 154 **6** 8011578952679 **9,90**

con 6 bit / with 6 bits mm 4 - 5 - PH1 - PH2 - PZ1 - PZ2

0087.310 con 6 bit / with 6 bits 190 **2** 8011578960728 **14,60**



utensili isolati
certificati VDE 1000 Volt 60900
impugnatura bicomponente
ergonomica

*insulated tools
VDE 1000 Volt 60900 certificated
ergonomic bicomponent handle*

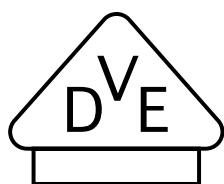

90

GIRAVITE ISOLATO 1000 volt VDE - PER VITI INTAGLIO - acciaio chrom-vanadium-molibdeno finitura punta nera
INSULATED SCREWDRIVER 1000 volt VDE - FOR SLOTTED HEAD - chrom-vanadium-molybdenum steel black finish tip

GOMMOGRIP MUNDIAL Impugnatura morbida bicomponente.
 Soft bicomponent handle.



Pro
INDUSTRIAL

Cr-Mo
ACCIAIO CRROMANIO
CHROMIUM VANADIUM MOLYBDENUM

HRC 60

Model	Tip Size	Length	Weight	Material	Price (€)	Tip Type
0090.258	2,5 x 0,4 x 80	87,5 x 25,4	28	6	4,20	Ridotto - Recessed
0090.310	3,0 x 0,5 x 100	87,5 x 25,4	32	6	4,60	Ridotto - Recessed
0090.410	4,0 x 0,8 x 100	109 x 31,7	60	6	5,35	Ridotto - Recessed
0090.512	5,5 x 1,0 x 125	109 x 31,7	46	6	6,40	Ridotto - Recessed
0090.615	6,5 x 1,2 x 150	117 x 34,0	104	6	8,35	Ridotto - Recessed
0090.817	8,0 x 1,6 x 150	127 x 36,9	156	6	11,10	Ridotto - Recessed

Ridotto
Recessed



92

GIRAVITE ISOLATO 1000 volt VDE - PER VITI CROCE PHILLIPS
INSULATED SCREWDRIVER 1000 volt VDE - FOR PHILLIPS CROSS

HRC 60

Model	Tip Size	Length	Weight	Material	Price (€)	Tip Type
0092.007	PH 0 x 75	87,5 x 25,4	30	6	3,60	Ridotto - Recessed
0092.110	PH 1 x 100	109 x 31,7	70	6	5,40	Ridotto - Recessed
0092.210	PH 2 x 100	117 x 34,0	86	6	7,45	Ridotto - Recessed
0092.315	PH 3 x 150	127 x 36,9	146	6	10,40	Ridotto - Recessed



Pro
INDUSTRIAL

Cr-Mo
ACCIAIO CRROMANIO
CHROMIUM VANADIUM MOLYBDENUM

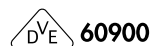

93

GIRAVITE ISOLATO 1000 volt VDE - PER VITI CROCE POZIDRIV
INSULATED SCREWDRIVER 1000 volt VDE - FOR POZIDRIV CROSS

HRC 60

Model	Tip Size	Length	Weight	Material	Price (€)	Tip Type
0093.007	PZ 0 x 75	87,5 x 25,4	28	6	4,05	Ridotto - Recessed
0093.110	PZ 1 x 100	109 x 31,7	68	6	6,35	Ridotto - Recessed
0093.210	PZ 2 x 100	117 x 34,0	88	6	8,00	Ridotto - Recessed
0093.315	PZ 3 x 150	127 x 36,9	142	6	11,20	Ridotto - Recessed



Pro
INDUSTRIAL

Cr-Mo
ACCIAIO CRROMANIO
CHROMIUM VANADIUM MOLYBDENUM

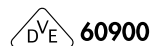

94

SERIE 5 GIRAVITI ISOLATI 1000 volt VDE - cartone
SET 5 INSULATED SCREWDRIVERS 1000 Volt VDE - box

Contenuto-content:

- 0090.310 3,0 x 0,5 x 100
- 0090.410 4,0 x 0,8 x 100
- 0090.512 5,5 x 1,0 x 125
- 0092.110 PH 1 x 100
- 0092.210 PH 2 x 100

Pro
INDUSTRIAL

Cr-Mo
ACCIAIO CRROMANIO
CHROMIUM VANADIUM MOLYBDENUM



Model	Dimensions	Weight	Price (€)
0094.010	310 x 180 x 37	474	31,75



95
SERIE 7 GIRAVITI ISOLATI 1000 volt VDE - cartone
 SET 7 INSULATED SCREWDRIVERS 1000 Volt VDE - box

Contenuto-content:

0090.310 3,0 x 0,5 x 100
 0090.410 4,0 x 0,8 x 100
 0090.512 5,5 x 1,0 x 125
 0090.615 6,5 x 1,2 x 150
 0092.007 PH 0 x 75
 0092.110 PH 1 x 100
 0092.210 PH 2 x 100



 0095.010 330 x 220 x 40



 646

 80115781000004
 8011578956745



 € 44,75
**96**
ESPOSITORE 101 GIRAVITI ISOLATI 1000 volt VDE - metallo
 DISPLAY STAND 101 INSULATED SCREWDRIVERS 1000 volt VDE - metal

Contenuto-content:

0090.258 2,5 x 0,4 x 80 Nr. 9
 0090.310 3,0 x 0,5 x 100 Nr. 9
 0090.410 4,0 x 0,8 x 100 Nr. 8
 0090.512 5,5 x 1,0 x 125 Nr. 8
 0090.615 6,5 x 1,2 x 150 Nr. 7
 0090.817 8,0 x 1,6 x 175 Nr. 6
 0092.007 PH 0 x 75 Nr. 9
 0092.110 PH 1 x 100 Nr. 8
 0092.210 PH 2 x 100 Nr. 7
 0092.315 PH 3 x 150 Nr. 6
 0093.007 PZ 0 x 75 Nr. 9
 0093.110 PZ 1 x 100 Nr. 8
 0093.210 PZ 2 x 100 Nr. 7



 0096.010 500 x 280 x 450
 0096.210 vuoto - empty



 14200
 6800

 80115781000004
 8011578956776
 8011578949266



 € 631,65
 70,00
**730**
ESPOSITORE GIRAVITI E PINZE ISOLATE 1000 volt VDE
 DISPLAY INSULATED SCREWDRIVERS AND PLIERS 1000 volt VDE

Contenuto-content:

0090.258 2,5 x 0,4 x 80 Nr. 9
 0090.310 3,0 x 0,5 x 100 Nr. 9
 0090.410 4,0 x 0,8 x 100 Nr. 8
 0090.512 5,5 x 1,0 x 125 Nr. 8
 0090.615 6,5 x 1,2 x 150 Nr. 7
 0090.817 8,0 x 1,6 x 175 Nr. 6
 0092.007 PH 0 x 75 Nr. 9
 0092.110 PH 1 x 100 Nr. 8
 0092.210 PH 2 x 100 Nr. 7
 0092.315 PH 3 x 150 Nr. 6
 0093.007 PZ 0 x 75 Nr. 9
 0093.110 PZ 1 x 100 Nr. 8
 0093.210 PZ 2 x 100 Nr. 7
 0710.018 Nr. 6
 0710.020 Nr. 6
 0712.016 Nr. 6
 0712.020 Nr. 6
 0714.020 Nr. 6
 0716.016 Nr. 6



 0730.010 475 x 215 x 600

 29250

 80115781000004
 8011578730000

 € 1.486,05

115 GIRAVITE PER VITI INTAGLIO-MECCANICI - acciaio chrom-vanadium finitura brunita - impugnatura in acetato
SCREWDRIVER FOR SLOTTED HEAD SCREWS-MECHANIC - chrom-vanadium steel black finish - acetate handle

DIN 5265 ISO 2380

Icona	Modello	Spina	Lunghezza	Manico	Capo	Barra	Barcode	Prezzo
	0115.206	2,0 x 0,4 x 60	60 x 12	7	12	8011578900014	€ 1,80	
	0115.256	2,5 x 0,4 x 60	60 x 12	8	12	8011578900045	€ 1,90	
	0115.307	3,0 x 0,5 x 75	69 x 16	18	12	8011578900106	€ 1,60	
	0115.310	3,0 x 0,5 x 100	69 x 16	18	12	8011578900137	€ 1,70	
	0115.410	4,0 x 0,8 x 100	93 x 21	42	12	8011578900199	€ 1,95	
	0115.512	5,5 x 1,0 x 125	93 x 21	52	12	8011578900281	€ 2,15	
	0115.612	6,5 x 1,2 x 125	102 x 24	76	12	8011578900373	€ 2,90	
	0115.615	6,5 x 1,2 x 150	102 x 24	78	12	8011578900403	€ 3,00	
	0115.815	8,0 x 1,2 x 150	114 x 28	140	6	8011578900434	€ 3,95	
	0115.920	10,0 x 1,6 x 200	128 x 34	264	6	8011578900496	€ 6,90	



116 GIRAVITE PER VITI CROCE PHILLIPS - acciaio chrom-vanadium finitura brunita - impugnatura in acetato
SCREWDRIVER FOR PHILLIPS CROSS HEAD SCREWS - chrom-vanadium steel black finish - acetate handle

DIN 5262 ISO 8764

Icona	Modello	Spina	Lunghezza	Manico	Capo	Barra	Prezzo
	0116.002	PH 00 x 60 x 2,0	60 x 12	8	12	8011578900526	€ 1,80
	0116.006	PH 0 x 60 x 3,0	69 x 16	16	12	8011578900557	€ 1,65
	0116.010	PH 0 x 100 x 3,0	69 x 16	18	12	8011578900588	€ 1,75
	0116.108	PH 1 x 80 x 4,5	93 x 21	42	12	8011578900618	€ 2,10
	0116.112	PH 1 x 125 x 4,5	93 x 21	48	12	8011578900649	€ 2,20
	0116.210	PH 2 x 100 x 6,0	102 x 24	70	12	8011578900670	€ 2,90
	0116.215	PH 2 x 150 x 6,0	102 x 24	80	12	8011578900700	€ 3,05
	0116.315	PH 3 x 150 x 8,0	114 x 28	138	6	8011578900731	€ 4,00



119C SERIE 5 GIRAVITI - cartone
SET 5 SCREWDRIVERS - box

Contenuto-content:

0115.307	3 x 75	0116.108	PH 1 x 80
0115.410	4 x 100	0116.210	PH 2 x 100
0115.612	6 x 125		

Icona	Modello	Dimensioni	Barra	Prezzo
	0119.310	310 x 180 x 37	396	8011578119157 € 13,65



119D SERIE 7 GIRAVITI - cartone
SET 7 SCREWDRIVERS - box

Contenuto-content:

0115.307	3 x 75	0116.006	PH 0 x 60
0115.410	4 x 100	0116.108	PH 1 x 80
0115.512	5 x 125	0116.210	PH 2 x 100
0115.612	6 x 125		

Icona	Modello	Dimensioni	Barra	Prezzo
	0119.410	330 x 220 x 40	506	8011578119171 € 18,35



121 ESPOSITORE 98 GIRAVITI - metallo
DISPLAY STAND 98 SCREWDRIVERS - metal

Contenuto-content:

0115.206	2 x 60	Nr. 9	0116.006	PH 0 x 60	Nr. 9
0115.307	3 x 75	Nr. 9	0116.108	PH 1 x 80	Nr. 7
0115.410	4 x 100	Nr. 14	0116.210	PH 2 x 100	Nr. 6
0115.512	5 x 125	Nr. 14	0137.160	6 x 30	Nr. 6
0115.612	6 x 125	Nr. 12	0137.210	PH 1 x 30	Nr. 6
0115.815	8 x 150	Nr. 6			

Icona	Modello	Dimensioni	Barra	Prezzo
	0121.010	410 x 230 x 200	9370	8011578121051 € 221,95
	0121.210	vuoto - empty	4700	8011578121105 € 55,00



130 GIRAVITE PER VITI INTAGLIO-MECCANICI - acciaio chrom-vanadium finitura cromata - impugnatura in acetato

SCREWDRIVER FOR SLOTTED HEAD SCREWS-MECHANIC - chrom-vanadium steel chrome plated finish - acetate handle

DIN 5265 ISO 2380

Icona	X	Diagramma	Icona	Icona	Icona	Barcode	€	Icona
						011578 000004		
0130.307	3,0 x 0,5 x 75	77 x 21	25	12	8011578901424	1,90		
0130.310	3,0 x 0,5 x 100	77 x 21	25	12	8011578901455	1,95		
0130.410	4,0 x 0,8 x 100	91 x 25	50	12	8011578901516	2,40		
0130.412	4,0 x 0,8 x 125	91 x 25	50	12	8011578901547	2,45		
0130.510	5,5 x 1,0 x 100	91 x 25	60	12	8011578901608	2,60		
0130.512	5,5 x 1,0 x 125	91 x 25	60	12	8011578901639	2,60		
0130.515	5,5 x 1,0 x 150	91 x 25	64	12	8011578901660	2,75		
0130.610	6,5 x 1,2 x 100	106 x 30	100	12	8011578901691	3,30		
0130.612	6,5 x 1,2 x 125	106 x 30	100	12	8011578901721	3,40		
0130.615	6,5 x 1,2 x 150	106 x 30	104	12	8011578901752	3,55		
0130.815	8,0 x 1,2 x 150	115 x 34	170	6	8011578901783	5,00		



132 GIRAVITE PER VITI INTAGLIO-LAME PARALLELE - acciaio chrom-vanadium finitura cromata - impugnatura in acetato

SCREWDRIVER FOR SLOTTED HEAD SCREWS-CABINET - chrom-vanadium steel chrome plated finish - acetate handle

DIN 5265 ISO 2380

Icona	X	Diagramma	Icona	Icona	Icona	Barcode	€	Icona
						011578 000004		
0132.310	3 x 0,5 x 100	77 x 21	25	12	8011578901844	1,95		
0132.415	4 x 0,8 x 150	91 x 25	53	12	8011578901905	2,60		
0132.515	5 x 1,0 x 150	91 x 25	60	12	8011578901967	2,75		



135 GIRAVITE PER VITI CROCE PHILLIPS - acciaio chrom-vanadium finitura cromata - impugnatura in acetato

SCREWDRIVER FOR PHILLIPS CROSS HEAD SCREWS - chrom-vanadium steel chrome plated finish - acetate handle

DIN 5262 ISO 8764

Icona	X	Diagramma	Icona	Icona	Icona	Barcode	€	Icona
						011578 000004		
0135.006	PH 0 x 60 x 3,0	77 x 21	24	12	8011578902056	1,95		
0135.010	PH 0 x 100 x 3,0	77 x 21	26	12	8011578902087	2,00		
0135.108	PH 1 x 80 x 4,5	91 x 25	52	12	8011578902117	2,65		
0135.112	PH 1 x 125 x 4,5	91 x 25	58	12	8011578902148	2,80		
0135.210	PH 2 x 100 x 6,0	106 x 30	94	12	8011578902179	3,45		
0135.215	PH 2 x 150 x 6,0	106 x 30	104	12	8011578902209	3,70		
0135.315	PH 3 x 150 x 8,0	115 x 34	172	6	8011578902230	5,10		



136 GIRAVITE PER VITI CROCE POZIDRIV - acciaio chrom-vanadium finitura cromata - impugnatura in acetato

SCREWDRIVER FOR POZIDRIV CROSS HEAD SCREWS - chrom-vanadium steel chrome plated finish - acetate handle

DIN 5262 ISO 8764

Icona	X	Diagramma	Icona	Icona	Icona	Barcode	€	Icona
						011578 000004		
0136.006	PZ 0 x 60 x 3,0	77 x 21	24	12	8011578902261	2,60		
0136.108	PZ 1 x 80 x 4,5	91 x 25	52	12	8011578902292	3,35		
0136.112	PZ 1 x 125 x 4,5	91 x 25	56	12	8011578902322	3,50		
0136.210	PZ 2 x 100 x 6,0	106 x 30	94	12	8011578902353	4,80		
0136.215	PZ 2 x 150 x 6,0	106 x 30	104	12	8011578902384	5,20		
0136.315	PZ 3 x 150 x 8,0	115 x 34	172	6	8011578902414	6,80		



137A GIRAVITE PER VITI INTAGLIO - acciaio chrom-vanadium finitura cromata - impugnatura in acetato

SCREWDRIVER FOR SLOTTED HEAD SCREWS - chrom-vanadium steel chrome plated finish - acetate handle

EX 118A DIN 5265 ISO 2380

Icona	X	Diagramma	Icona	Icona	Icona	Barcode	€	Icona
						011578 000004		
0137.140	4,0 x 0,8 x 30	52 x 30	32	12	8011578902445	2,25		
0137.160	6,5 x 1,2 x 30	52 x 30	40	12	8011578902476	2,45		









137B GIRAVITE PER VITI CROCE PHILLIPS
 SCREWDRIVER PHILLIPS CROSS HEAD SCREWS

EX 118B







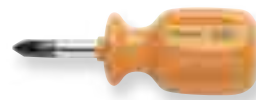

DIN 5262 ISO 8764

							€
0137.210	PH 1 x 30x4,5	52 x 30	34	12	8011578902506		2,30
0137.220	PH 2 x 30x6,0	52 x 30	40	12	8011578902537		2,45







137C GIRAVITE PER VITI CROCE POZIDRIV
 SCREWDRIVER POZIDRIV CROSS HEAD SCREWS



DIN 5262 ISO 8764







							€
0137.310	PZ 1 x 30x4,5	52 x 30	34	12	8011578902568		3,25
0137.320	PZ 2 x 30x6,0	52 x 30	40	12	8011578902599		3,50

138 GIRAVITE PER VITI INTAGLIO SERIE LUNGA - acciaio chrom-vanadium finitura cromata - impugnatura in acetato
 SCREWDRIVER FOR SLOTTED HEAD SCREWS LONG TYPE - chrom-vanadium steel chrome plated finish - acetate handle

							€
0138.325	3 x 0,5 x 250	77 x 21	34	6	8011578902681		3,90
0138.430	4 x 0,8 x 300	91 x 25	68	6	8011578902742		4,90
0138.630	6 x 1,2 x 300	106 x 30	132	6	8011578902803		6,00



139 GIRAVITE PER VITI CROCE PHILLIPS SERIE LUNGA - acciaio chrom-vanadium finitura cromata - impugnatura in acetato
 SCREWDRIVER FOR PHILLIPS CROSS HEAD SCREWS LONG TYPE - chrom-vanadium steel chrome plated finish - acetate handle

							€
0139.025	PH 0 x 250 x 3,0	77 x 21	34	6	8011578902834		4,65
0139.130	PH 1 x 300 x 4,5	91 x 25	76	6	8011578902896		5,45
0139.230	PH 2 x 300 x 6,0	106 x 30	132	6	8011578902957		6,35



147C SERIE 5 GIRAVITI - cartone
 SET 5 SCREWDRIVERS - box

Contenuto-content:

0130.307	3 x 75	0135.108	PH 1 x 80
0130.410	4 x 100	0135.210	PH 2 x 100
0130.612	6 x 125		

				€		
0147.310	310 x 180 x 37	468	8011578147051	15,50		



147D SERIE 7 GIRAVITI - cartone
 SET 7 SCREWDRIVERS - box

Contenuto-content:

0130.307	3 x 75	0135.006	PH 0 x 60
0130.410	4 x 100	0135.108	PH 1 x 80
0130.510	5 x 100	0135.210	PH 2 x 100
0130.612	6 x 125		

				€		
0147.410	330 x 220 x 40	588	8011578147099	21,65		



148 ESPOSITORE 98 GIRAVITI - metallo
 DISPLAY STAND 98 SCREWDRIVERS - metal

Contenuto-content:

0130.307	3 x 75	Nr. 9	0130.612	6 x 125	Nr. 6
0130.310	3 x 100	Nr. 9	0130.815	8 x 150	Nr. 6
0130.410	4 x 100	Nr. 7	0135.006	PH 0 x 60	Nr. 9
0130.412	4 x 125	Nr. 7	0135.108	PH 1 x 80	Nr. 7
0130.510	5 x 100	Nr. 7	0135.210	PH 2 x 100	Nr. 6
0130.512	5 x 125	Nr. 7	0137.160	6 x 30	Nr. 6
0130.610	6 x 100	Nr. 6	0137.210	PH 1 x 30	Nr. 6

				€		
0148.010	410 x 230 x 200	10500	8011578148058	260,50		
0148.210	vuoto - empty	4600	8011578148102	55,00		



162
GIRAVITE PER VITI INTAGLIO - elettronica - acciaio chrom-vanadium fin. cromata punta nera - impugnatura bicomponente
SCREWDRIVER FOR SLOTTED HEAD SCREWS - electronics - chrom-vanadium steel chrome plated finish tip - bicomp. handle

DIN 5265 ISO 2380

Icona	Modello	Dimensioni	Lunghezza	Spessore	Quantità	Barcode	Prezzo	Icona
		X				81157811000004	€	
	0162.105	1,5 x 0,3 x 50	88 x 16	15	12	8011578904661	2,20	
	0162.206	2,0 x 0,4 x 50	88 x 16	15	12	8011578904692	2,20	
	0162.207	2,5 x 0,4 x 50	88 x 16	15	12	8011578904722	2,20	
	0162.310	3,0 x 0,5 x 50	88 x 16	15	12	8011578904753	2,20	

163
GIRAVITE PER VITI CROCE PHILLIPS - elettronica - acciaio chrom-vanadium fin. cromata punta nera - imp. bicomponente
SCREWDRIVER FOR PHILLIPS CROSS HEAD SCREWS - electronics - chrom-vanadium steel chrome plated finish tip - bicomp. handle

DIN 5262 ISO 8764



Icona	Modello	Dimensioni	Lunghezza	Spessore	Quantità	Barcode	Prezzo	Icona
		X				81157811000004	€	
	0163.005	PH 000 x 50 x 2,5	88 x 16	15	12	8011578904814	2,20	
	0163.006	PH 00 x 50 x 3,0	88 x 16	15	12	8011578904845	2,20	
	0163.015	PH 0 x 50 x 3,0	88 x 16	15	12	8011578904876	2,20	

163X
GIRAVITE PER VITI TORX - elettronica - acciaio chrom-vanadium fin. cromata punta nera - impugnatura bicomponente
SCREWDRIVER FOR TORX-HEAD SCREWS - electronics - chrom-vanadium steel chrome plated finish tip - bicomp. handle

Icona	Modello	Dimensioni	Lunghezza	Spessore	Quantità	Barcode	Prezzo	Icona
		X				81157811000004	€	
	0163.904	TX 4 x 50	82 x 16	13	12	8011578985226	2,20	
	0163.905	TX 5 x 50	82 x 16	13	12	8011578985264	2,20	
	0163.906	TX 6 x 50	82 x 16	13	12	8011578933265	2,20	
	0163.907	TX 7 x 50	82 x 16	13	12	8011578933289	2,20	
	0163.908	TX 8 x 50	82 x 16	13	12	8011578933302	2,20	
	0163.909	TX 9 x 50	82 x 16	13	12	8011578933326	2,20	
	0163.910	TX 10 x 50	82 x 16	14	12	8011578933340	2,20	
	0163.915	TX 15 x 50	82 x 16	16	12	8011578933364	2,20	
	0163.920	TX 20 x 50	82 x 16	18	12	8011578933388	2,20	

164
SERIE 7 GIRAVITI INTAGLIO - CROCE - TORX - PER ELETTRONICA
SET 7 SCREWDRIVERS SLOT - CROSS- TORX - FOR ELECTRONICS



Contenuto-content:

0162.105	1,5 x 50	  
0162.206	2 x 50	
0163.005	PH 000 x 50	
0163.006	PH 00 x 50	
0163.905	TX 5 x 50	
0163.906	TX 6 x 50	
0163.908	TX 8 x 50	

Icona	Modello	Dimensioni	Quantità	Barcode	Prezzo	Icona
				81157811000004	€	
	0164.010	170 x 130 x 25	214	8011578164003	15,90	new



170 GIRAVITE per viti INTAGLIO tipo STANDARD - acciaio chrom-vanadium fin. cromata punta nera - imp. bicomponente
 SCREWDR. for SLOT. HEAD screws - STANDARD type - chrom-vanadium steel chrome plated black fin. tip - bic. handle

		X					€	
0170.307	3,0 x 0,5 x 75	88 x 27	36	12	8011578980108	1,90 new		
0170.410	4,0 x 0,8 x 100	88 x 27	43	12	8011578980160	2,05 new		
0170.510	5,5 x 1,0 x 100	100 x 31	63	12	8011578980184	2,45 new		
0170.612	6,5 x 1,2 x 125	110 x 34	88	12	8011578980245	3,00 new		

172 GIRAVITE per viti CROCE PHILLIPS tipo STANDARD - acciaio chrom-vanadium fin. cromata punta nera - imp. bicomp.
 SCREWDR. for PHILLIPS CROSS HEAD screws - STANDARD type - chrom-vanadium st. chrome plated black fin. tip - bic. han.

		X					€	
0172.007	PH 0 x 70 x 3,0	88 x 27	36	12	8011578980306	1,90 new		
0172.110	PH 1 x 100 x 4,5	100 x 31	65	12	8011578980368	2,45 new		
0172.210	PH 2 x 100 x 6,0	110 x 34	88	12	8011578980382	2,90 new		

173 GIRAVITE per viti CROCE POZIDRIV tipo STANDARD - acciaio chrom-vanadium fin. cromata punta nera - imp. bicomp.
 SCREWDR. for POZIDRIV CROSS HEAD screws - STANDARD type - chrom-vanadium st. chrome plat. black finish tip - bicomp. han.

		X					€	
0173.110	PZ 1 x 100 x 4,5	100 x 31	65	12	8011578980443	2,55 new		
0173.210	PZ 2 x 100 x 6,0	110 x 34	88	12	8011578980467	2,90 new		

177 SERIE 5 GIRAVITI tipo STANDARD - impugnatura bicomponente - intaglio - croce PH - termoformato
 SET 5 SCREWDRIVERS - STANDARD type - bicomponent handle - slotted - cross PH - thermoformed



Contenuto-content:
 0170.410 4 x 100
 0170.615 6 x 150
 0172.007 PH 0 x 75
 0172.108 PH 1 x 100
 0172.210 PH 2 x 100

Espositore banco Pz. 12 - Table display Pc. 12

					€		
0177.010	315 x 135 x 40	410	12	8011578963125	13,90 new		





179 ESPOSITORE 72 GIRAVITI tipo STANDARD - cartone
 DISPLAY STAND 72 SCREWDRIVERS - STANDARD type - box



Contenuto-content:
 170.307 3 x 75 Nr. 12 0172.007 PH 0 x 70 Nr. 12
 170.410 4 x 100 Nr. 12 0172.108 PH 1 x 100 Nr. 12
 170.612 6 x 125 Nr. 12 0172.210 PH 2 x 100 Nr. 12



					€	
0179.010	470 x 260 x 100	6900		8011578980481	170,40 new	

184 GIRAVITE PER VITI INTAGLIO - acciaio chrom-vanadium finitura nichelata - impugnatura in acetato
SCREWDRIVER FOR SLOTTED HEAD SCREWS - chrom-vanadium steel nickel plated finish - acetate handle

Icona	Modello	Dimensioni	Lunghezza	Spessore	Quantità	Barcode	Prezzo
	0184.307	3,0 x 0,5 x 75	69 x 16	16	12	8011578905293	1,25
	0184.407	4,0 x 0,8 x 75	93 x 21	40	12	8011578905323	1,70
	0184.510	5,5 x 1,0 x 100	93 x 21	52	12	8011578905354	1,80
	0184.612	6,5 x 1,2 x 125	102 x 24	76	12	8011578905385	2,00





186 GIRAVITE PER VITI CROCE PHILLIPS - acciaio chrom-vanadium finitura nichelata - impugnatura in acetato
SCREWDRIVER FOR PHILLIPS CROSS HEAD SCREWS - chrom-vanadium steel nickel plated finish - acetate handle

Icona	Modello	Dimensioni	Lunghezza	Spessore	Quantità	Barcode	Prezzo
	0186.006	PH 0 x 60 x 3,0	69 x 16	16	12	8011578905415	1,25
	0186.108	PH 1 x 80 x 4,5	93 x 21	42	12	8011578905446	1,70
	0186.210	PH 2 x 100 x 6,0	102 x 24	68	12	8011578905477	2,00



188 GIRAVITE PER VITI CROCE POZIDRIV - acciaio chrom-vanadium finitura nichelata - impugnatura in acetato
SCREWDRIVER FOR POZIDRIV CROSS HEAD SCREWS - chrom-vanadium steel nickel plated finish - acetate handle

Icona	Modello	Dimensioni	Lunghezza	Spessore	Quantità	Barcode	Prezzo
	0188.108	PZ 1 x 80 x 4,5	93 x 21	42	12	8011578905507	1,80
	0188.210	PZ 2 x 100 x 6,0	102 x 24	72	12	8011578905538	2,10



190 SERIE 6 GIRAVITI - termoformato
SET 6 SCREWDRIVERS - thermoformed



Contenuto-content:
0184.307 3 x 75 0184.612 6 x 125
0184.407 4 x 75 0186.108 PH 1 x 80
0184.510 5 x 100 0186.210 PH 2 x 100

Espositore banco Pz. 12 - Table display Pz. 12

Icona	Modello	Dimensioni	Quantità	Barcode	Prezzo
	0190.010	240 x 90 x 27	320	12 8011578190002	11,15

193 ESPOSITORE 144 GIRAVITI - cartone
DISPLAY STAND 144 SCREWDRIVERS - box



Contenuto-content:
0184.307 3 x 75 Nr. 24 0186.006 PH 0 x 60 Nr. 24
0184.407 4 x 75 Nr. 24 0186.108 PH 1 x 80 Nr. 24
0184.612 6 x 125 Nr. 24 0186.210 PH 2 x 100 Nr. 24

Icona	Modello	Dimensioni	Quantità	Barcode	Prezzo
	0193.010	470 x 260 x 100	6900	12 8011578193058	237,60



206 GIRAVITE REVERSIBILE INTAGLIO-CROCE
 REVERSIBLE SCREWDRIVER SLOTTED-CROSS



0206.060 PH 2 x 60 x 6,0 90 x 20 48 12 8011578905682 € 1,90

222 GIRAVITE CERCAFASE
 CIRCUIT TESTER SCREWDRIVER



0222.410 4 x 100 95 x 25 32 12 8011578943141 € 3,20

223 GIRAVITE CERCAFASE
 CIRCUIT TESTER SCREWDRIVER



0223.306 3 x 60 88 x 21 20 12 8011578943165 € 2,90

225 GIRAVITE CERCAFASE - chrom-vanadium - lama isolata
 CIRCUIT TESTER SCREWDRIVER - chrom-vanadium - insulated blade



CE
 0225.410 4 x 0,8 x 100 90 x 18 34 12 8011578905897 € 2,10

232 GIRAVITE CERCAFASE - chrom-vanadium - lama isolata
 CIRCUIT TESTER SCREWDRIVER - chrom-vanadium - insulated blade



CE
 0232.306 3 x 0,5 x 60 75 x 15 22 12 8011578905927 € 1,80



0010.015

0012.015



234 SERIE 31 INSERTI E PORTAINSERTI SGANCIO RAPIDO
 SET 31 BITS AND QUICK RELEASE HOLDER



Contenuto-content:

239.010		253.100	TX 10	
249.350	3,5 x 25	253.150	TX 15	
249.400	4 x 25	253.200	TX 20	
249.550	5,5 x 25	253.250	TX 25	
249.600	6 x 25	253.270	TX 27	
249.650	6,5 x 25	253.300	TX 30	
250.100	PH 1 x 25	Nr. 2	253.400	TX 40
250.200	PH 2 x 25	Nr. 2	263.020	ES. /HEX. mm 2
250.300	PH 3 x 25		263.025	ES. /HEX. mm 2,5
251.100	PZ 1 x 25	Nr. 2	263.030	ES. /HEX. mm 3
251.200	PZ 2 x 25	Nr. 2	263.040	ES. /HEX. mm 4
251.300	PZ 3 x 25		263.050	ES. /HEX. mm 5
253.080	TX 8		263.060	ES. /HEX. mm 6
253.090	TX 9			



 **0234.010**   270 **9**  8011578237059  **21,00**

234.900 ESPOSITORE 9 SERIE 31 INSERTI E PORTAINSERTI SGANCIO RAPIDO
 CARTON 9 DISPLAY SET 31 BITS AND QUICK RELEASE HOLDER



Contenuto-content:

0234.010 Nr. 9



 **0234.900**  300 x 200 x 260  2700  8011578972547  **189,00**

236 SERIE 10 INSERTI E PORTAINSERTI
 SET 10 BITS AND HOLDER



Contenuto-content:

0240.010		0250.200	PH 2 x 25
0249.400	4 x 25	0250.300	PH 3 x 25
0249.500	5 x 25	0251.100	PZ 1 x 25
0249.600	6 x 25	0251.200	PZ 2 x 25
0250.100	PH 1 x 25	0251.300	PZ 3 x 25



 **0236.010**  114 **10**  8011578236052  **9,90**

236.900 ESPOSITORE IN CARTONE 10 SERIE INSERTI E PORTAINSERTI
 CARTON DESK DISPLAY 10 SET BITS AND HOLDER



Contenuto-content:

0236.010 Nr. 10



 **0236.900**  260 x 260 x 260  1315  8011578949488  **99,00**

238 PORTAUTENSILI 1/4" - magnetico - prendivite
HOLDER 1/4" - magnetic - Screw cap



					€
0238.010	1/4"	60	24 6	8011578933401	8,10

239 PORTAUTENSILI 1/4" - sgancio rapido - magnetico
HOLDER 1/4" - quick release - magnetic



					€
0239.010	1/4"	60	30 6	8011578933425	7,20

240 PORTAINSERI CON ANELLO 1/4" - magnetico
HOLDER WITH RING 1/4" - magnetic



DIN 7427

					€
0240.005	1/4"	50	28 6	8011578960940	3,15
0240.010	1/4"	75	36 6	8011578906016	4,40
0240.020	1/4"	100	40 6	8011578946685	5,55
0240.030	1/4"	150	50 6	8011578972561	10,50
0240.040	1/4"	200	60 6	8011578972585	12,60

241 ADATTATORE 1/4"
ADAPTER 1/4"



					€
0241.014	1/4"	50	15 6	8011578906047	1,25
0241.038	3/8"	50	22 6	8011578906078	1,65
0241.120	1/2"	50	25 6	8011578949501	2,35

243 CHIAVE A BUSSOLA 1/4" - magnetica
NUTSETTERS 1/4" - magnetic



DIN 7424

					€
0243.060	6	45	18 6	8011578933449	2,55
0243.070	7	45	18 6	8011578933463	2,55
0243.080	8	45	22 6	8011578933487	2,55
0243.100	10	45	24 6	8011578933500	2,75
0243.110	11	45	26 6	8011578933524	2,95
0243.120	12	45	32 6	8011578933548	2,95
0243.130	13	45	32 6	8011578933562	3,50
0243.170	17	45	40 6	8011578972769	5,30
0243.380	3/8"	45	32 6	8011578965884	3,15

244 CHIAVE A BUSSOLA 1/4" - lunga - magnetica
NUTSETTERS 1/4" - long - magnetic

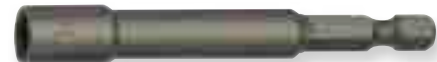

					€
0244.045	4	100	22 6	8011578949525	3,80
0244.055	5	100	22 6	8011578949549	3,80
0244.065	6	100	23 6	8011578946760	3,80
0244.075	7	100	23 6	8011578946807	3,80
0244.085	8	100	24 6	8011578946845	3,80
0244.105	10	100	29 6	8011578946883	4,25
0244.125	12	100	37 6	8011578946944	4,55
0244.135	13	100	37 6	8011578947002	5,05

245 INSERTO PHILLIPS 1/4" - lungo
BIT PHILLIPS HEAD SCREWS 1/4"



DIN 3128 ISO 1173

					€
0245.100	PH 1	75	12 6	8011578906108	1,20
0245.109	PH 1	90	14 6	8011578945688	1,80
0245.115	PH 1	150	22 6	8011578945701	3,00
0245.200	PH 2	75	15 6	8011578906139	1,20
0245.209	PH 2	90	20 6	8011578945725	1,80
0245.215	PH 2	150	34 6	8011578945749	3,00

246 INSERTO POZIDRIV 1/4" - lungo
BIT POZIDRIV HEAD SCREWS 1/4"



DIN 3128 ISO 1173

					€
0246.100	PZ 1	75	12 6	8011578906160	1,20
0246.109	PZ 1	90	14 6	8011578945763	1,80
0246.115	PZ 1	150	22 6	8011578945787	3,00
0246.200	PZ 2	75	15 6	8011578906191	1,20
0246.209	PZ 2	90	20 6	8011578945800	1,80
0246.215	PZ 2	150	34 6	8011578945824	3,00

249 INSERTO PER VITI INTAGLIO 1/4"
BIT FOR SLOTTED HEAD SCREWS 1/4"



DIN 3127 ISO 2351

					€
0249.400	4	25	4 12	8011578906221	0,60
0249.400-100	4	25	4 100	8011578949846	0,50
0249.500	5	25	4 12	8011578906252	0,60
0249.500-100	5	25	4 100	8011578949860	0,50
0249.600	6	25	4 12	8011578906283	0,60
0249.600-100	6	25	4 100	8011578949884	0,50

250 INSERTO CROCE PHILLIPS 1/4" - acciaio legato speciale
BIT PHILLIPS CROSS HEAD SCREWS 1/4" - sp. alloy steel

 ACR antiscivolo/no slip
DIN 3128 ISO 1173



Model	Size	Length	Material	Quantity	Price
0250.100	PH 1	25	5 12	8011578906313	0,60
0250.100-100	PH 1	25	5 100	8011578949907	0,50
0250.200	PH 2	25	5 12	8011578906344	0,60
0250.200-100	PH 2	25	5 100	8011578949921	0,50
0250.300	PH 3	25	5 12	8011578906375	0,60
0250.300-100	PH 3	25	5 100	8011578949945	0,50

250T INSERTO PER VITI CROCE PHILLIPS 1/4" - titanium
BIT PHILLIPS CROSS HEAD SCREWS 1/4" - titanium

 ACR antiscivolo/no slip
DIN 3128 ISO 1173



Model	Size	Length	Material	Quantity	Price
0250.910	PH 1	25	5 12	8011578934125	1,20
0250.920	PH 2	25	5 12	8011578934149	1,20
0250.930	PH 3	25	5 12	8011578934163	1,20

250Z INSERTO CROCE PHILLIPS 1/4" - TORSION
BIT PH CROSS HEAD SCREWS 1/4" - TORSION



Model	Size	Length	Material	Quantity	Price
0250.810	PH 1	25	4 12	8011578972608	0,85
0250.820	PH 2	25	4 12	8011578972622	0,85

251 INSERTO CROCE POZIDRIV 1/4" -
BIT PZ CROSS HEAD SCREWS 1/4"

 ACR antiscivolo/no slip
DIN 3128 ISO 1173



Model	Size	Length	Material	Quantity	Price
0251.100	PZ 1	25	5 12	8011578906405	0,60
0251.100-100	PZ 1	25	5 100	8011578949969	0,50
0251.200	PZ 2	25	5 12	8011578906436	0,60
0251.200-100	PZ 2	25	5 100	8011578949983	0,50
0251.300	PZ 3	25	5 12	8011578906467	0,60
0251.300-100	PZ 3	25	5 100	8011578960001	0,50

251T INSERTO CROCE POZIDRIV 1/4" - titanium
BIT PZ CROSS HEAD SCREWS 1/4" - titanium

 ACR antiscivolo/no slip



Model	Size	Length	Material	Quantity	Price
0251.910	PZ 1	25	4 12	8011578934187	1,20
0251.920	PZ 2	25	5 12	8011578934200	1,20
0251.930	PZ 3	25	5 12	8011578934224	1,20

251Z INSERTO CROCE POZIDRIV 1/4" - TORSION
BIT PZ CROSS HEAD SCREWS 1/4" - TORSION



Model	Size	Length	Material	Quantity	Price
0251.810	PZ 1	25	4 12	8011578972646	0,85
0251.820	PZ 2	25	4 12	8011578972660	0,85

253 INSERTO PER VITI TORX 1/4"
BIT FOR TORX HEAD SCREWS 1/4"



Model	Size	Length	Material	Quantity	Price
0253.060	TX 6	25	4 12	8011578947040	0,65
0253.070	TX 7	25	4 12	8011578947064	0,65
0253.080	TX 8	25	4 12	8011578906498	0,65
0253.090	TX 9	25	4 12	8011578906528	0,65
0253.100	TX 10	25	4 12	8011578906559	0,65
0253.150	TX 15	25	5 12	8011578906580	0,65
0253.200	TX 20	25	5 12	8011578906610	0,65
0253.250	TX 25	25	5 12	8011578906641	0,65
0253.270	TX 27	25	5 12	8011578906672	0,65
0253.300	TX 30	25	5 12	8011578906702	0,65
0253.400	TX 40	25	5 12	8011578971816	0,65

255 INSERTO TORX CON FORO 1/4"
BIT TORX HEAD SCREWS WITH HOLE 1/4"



Model	Size	Length	Material	Quantity	Price
0255.060	TX 6	25	4 12	8011578933586	0,90
0255.070	TX 7	25	4 12	8011578933609	0,90
0255.080	TX 8	25	4 12	8011578932350	0,90
0255.090	TX 9	25	4 12	8011578932381	0,90
0255.100	TX 10	25	4 12	8011578932411	0,90
0255.150	TX 15	25	5 12	8011578932442	0,90
0255.200	TX 20	25	5 12	8011578932473	0,90
0255.250	TX 25	25	5 12	8011578932503	0,90
0255.270	TX 27	25	5 12	8011578932534	0,90
0255.300	TX 30	25	5 12	8011578932565	0,90
0255.400	TX 40	25	5 12	8011578938666	0,90

255Z INSERTO TORX CON FORO 1/4"
BIT TORX HEAD SCREWS WITH HOLE 1/4"



Model	Size	Length	Material	Quantity	Price
0255.906	TX 6	50	8 12	8011578945848	1,35
0255.907	TX 7	50	8 12	8011578945862	1,35
0255.908	TX 8	50	8 12	8011578945886	1,35
0255.909	TX 9	50	8 12	8011578945909	1,35
0255.910	TX 10	50	8 12	8011578945923	1,35
0255.915	TX 15	50	8 12	8011578945947	1,35
0255.920	TX 20	50	8 12	8011578945961	1,35
0255.925	TX 25	50	10 12	8011578945985	1,35
0255.927	TX 27	50	10 12	8011578946005	1,35
0255.930	TX 30	50	12 12	8011578946029	1,35
0255.940	TX 40	50	12 12	8011578946043	1,35

256 INSERTO QUADRO 1/4"
 BIT-SQUARE 1/4"



Icon	Model	Length	Width	Quantity	Barcode	Price	
						€	
	0256.100	SQ 1	25	4	12	8011578933623	0,65
	0256.200	SQ 2	25	5	12	8011578933647	0,65
	0256.300	SQ 3	25	5	12	8011578943660	0,65

258 INSERTO POZIDRIV 1/4"
 BIT POZIDRIV HEAD SCREWS 1/4"



DIN 3128 ISO 1173

Icon	Model	Length	Width	Quantity	Barcode	Price	
						€	
	0258.100	PZ 1	50	11	12	8011578906733	0,90
	0258.100-100	PZ 1	50	11	100	8011578960025	0,80
	0258.200	PZ 2	50	11	12	8011578906764	0,90
	0258.200-100	PZ 2	50	11	100	8011578960049	0,80
	0258.300	PZ 3	50	11	12	8011578906795	0,90
	0258.300-100	PZ 3	50	11	100	8011578960063	0,80
	0258.400	PZ 4	50	12	12	8011578943844	2,15

258T INSERTO POZIDRIV 1/4" - titanium
 BIT POZIDRIV HEAD SCREWS 1/4" - titanium



DIN 3128 ISO 1173

Icon	Model	Length	Width	Quantity	Barcode	Price	
						€	
	0258.910	PZ 1	50	11	12	8011578960902	2,15
	0258.920	PZ 2	50	11	12	8011578960926	2,15

258Z INSERTO POZIDRIV 1/4" - TORSION
 BIT POZIDRIV HEAD SCREWS 1/4" - TORSION



DIN 3128 ISO 1173

Icon	Model	Length	Width	Quantity	Barcode	Price	
						€	
	0258.810	PZ 1	50	4	12	8011578972721	1,50
	0258.820	PZ 2	50	4	12	8011578972745	1,50

260 INSERTO CROCE PHILLIPS 1/4"
 BIT PHILLIPS CROSS HEAD SCREWS 1/4"



DIN 3128 ISO 1173

Icon	Model	Length	Width	Quantity	Barcode	Price	
						€	
	0260.100	PH 1	50	11	12	8011578906825	0,90
	0260.100-100	PH 1	50	11	100	8011578960100	0,80
	0260.200	PH 2	50	11	12	8011578906856	0,90
	0260.200-100	PH 2	50	11	100	8011578960124	0,80
	0260.300	PH 3	50	11	12	8011578906887	0,90
	0260.300-100	PH 3	50	11	100	8011578960148	0,80
	0260.400	PH 4	50	12	12	8011578946067	2,15

260T INSERTO CROCE PHILLIPS 1/4" - titanium
 BIT PHILLIPS CROSS HEAD SCREWS 1/4" - titanium



DIN 3128 ISO 1173

Icon	Model	Length	Width	Quantity	Barcode	Price	
						€	
	0260.910	PH 1	50	11	12	8011578960841	2,15
	0260.920	PH 2	50	11	12	8011578960865	2,15

260Z INSERTO CROCE PHILLIPS 1/4" - TORSION
 BIT PHILLIPS CROSS HEAD SCR. 1/4" - TORSION



DIN 3128 ISO 1173

Icon	Model	Length	Width	Quantity	Barcode	Price	
						€	
	0260.810	PH 1	50	11	12	8011578972684	1,50
	0260.820	PH 2	50	11	12	8011578972707	1,50

262 INSERTO PER VITI INTAGLIO 1/4"
 BIT FOR SLOTTED HEAD SCREWS 1/4"



Icon	Model	Length	Width	Quantity	Barcode	Price	
						€	
	0262.400	4	50	11	12	8011578906917	0,90
	0262.400-100	4	50	11	100	8011578960186	0,75
	0262.500	5	50	11	12	8011578906948	0,90
	0262.500-100	5	50	11	100	8011578960209	0,75
	0262.600	6	50	11	12	8011578906979	0,90
	0262.600-100	6	50	11	100	8011578960223	0,75

263 INSERTO VITI ESAGONO 1/4"
 BIT HEXAGON HEAD SCREWS 1/4"



DIN 7426

Icon	Model	Length	Width	Quantity	Barcode	Price	
						€	
	0263.015	1,5	25	4	12	8011578933685	0,60
	0263.020	2,0	25	4	12	8011578943585	0,60
	0263.025	2,5	25	4	12	8011578907006	0,60
	0263.030	3,0	25	4	12	8011578907037	0,60
	0263.040	4,0	25	5	12	8011578907099	0,60
	0263.050	5,0	25	5	12	8011578907129	0,60
	0263.060	6,0	25	6	12	8011578907150	0,60

263Z INSERTO ESAGONO MASCHIO
 HEXAGON MALE BIT



DIN 7426

Icon	Model	Length	Width	Quantity	Barcode	Price	
						€	
	0263.930	3	50	8	12	8011578946081	1,00
	0263.940	4	50	10	12	8011578946104	1,00
	0263.950	5	50	12	12	8011578946128	1,00
	0263.960	6	50	12	12	8011578946142	1,00



266 CASSETTA CACCIAVITE A PERCUSSIONE 1/2" CON 6 INSERTI
 SET IMPACT SCREWDRIVER 1/2" WITH 6 BITS

Contenuto-content:

- PH 2
- PH 3
- INTAGLIO - SLOT mm 8
- INTAGLIO - SLOT mm 10



 **0266.010**   1100 **1**  8011578974589  **40,30**

1420 ADATTATORE 1/4" portainseriti univ. es. 1/4"
 ADAPTER COUPLER 1/4" for bit hexagon 1/4"

1/4"



 **1420.010**   14 **6**  8011578929626  **3,45**

1470 ADATTATORE 3/8" portainseriti univ. es. 1/4"
 ADAPTER COUPLER 3/8" for bit hexagon 1/4"

3/8"



 **1470.010**   24 **6**  8011578930370  **3,85**

1520 ADATTATORE 1/2" portainseriti univ. es. 1/4"
 ADAPTER COUPLER 1/2" for bit hexagon 1/4"

1/2"







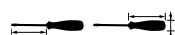

 **1520.010**   52 **6**  8011578949563  **4,35**

84 PORTAINSERITI MAGNETICO ATTACCO 1/4"
 MAGNETIC BIT HOLDER 1/4"

1/4"

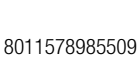

 **0084.010** **1/4"**  100 117 x 34   100 **6**  8011578952648  **6,25**







con 6 bit / with 6 bits mm 4 - 5 - PH1 - PH2 - PZ1 - PZ2
0084.310 con 6 bit / with 6 bits 190 **2**  8011578985509  **9,65**





87 PORTAINSERITI FLESSIBILE ATTACCO 1/4"
 FLEXIBLE BIT HOLDER 1/4"

1/4"

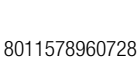

 **0087.010** **1/4"**  190 117 x 34   154 **6**  8011578952679  **9,90**

con 6 bit / with 6 bits mm 4 - 5 - PH1 - PH2 - PZ1 - PZ2
0087.310 con 6 bit / with 6 bits 190 **2**  8011578960728  **14,60**



270 INSERTO ESAGONO MASCHIO mm 10
 HEXAGON MALE BIT mm 10



Icona	Modello	Spessore	Lunghezza	Spessore	Quantità	Barcode	Prezzo
	0270.040	4	75	44	6	8011578946166	2,30
	0270.050	5	75	44	6	8011578946180	2,30
	0270.060	6	75	46	6	8011578946203	2,30
	0270.080	8	75	48	6	8011578946227	2,30
	0270.100	10	75	51	6	8011578946241	2,30

274 INSERTO XZN mm 10
 XZN BIT mm 10



Icona	Modello	Spessore	Lunghezza	Spessore	Quantità	Barcode	Prezzo
	0274.005	XZN 5	75	44	6	8011578946425	2,75
	0274.006	XZN 6	75	46	6	8011578946449	2,75
	0274.008	XZN 8	75	46	6	8011578946463	2,75
	0274.010	XZN 10	75	48	6	8011578946487	2,75
	0274.012	XZN 12	75	62	6	8011578946500	2,75

272 INSERTO TORX mm 10
 TORX BIT mm 10



Icona	Modello	Spessore	Lunghezza	Spessore	Quantità	Barcode	Prezzo
	0272.020	TX 20	75	44	6	8011578946265	2,35
	0272.025	TX 25	75	44	6	8011578946289	2,35
	0272.027	TX 27	75	42	6	8011578946302	2,35
	0272.030	TX 30	75	44	6	8011578946326	2,35
	0272.040	TX 40	75	46	6	8011578945664	2,35
	0272.045	TX 45	75	46	6	8011578946364	2,35
	0272.050	TX 50	75	48	6	8011578946388	2,35
	0272.055	TX 55	75	50	6	8011578946401	2,35

275 INSERTO RIBE mm 10
 RIBE BIT mm 10



Icona	Modello	Spessore	Lunghezza	Spessore	Quantità	Barcode	Prezzo
	0275.005	RIBE 5	75	43	6	8011578946524	2,75
	0275.006	RIBE 6	75	44	6	8011578946548	2,75
	0275.007	RIBE 7	75	45	6	8011578946562	2,75
	0275.008	RIBE 8	75	46	6	8011578946586	2,75
	0275.009	RIBE 9	75	46	6	8011578946609	2,75
	0275.010	RIBE 10	75	48	6	8011578946623	2,75
	0275.012	RIBE 12	75	62	6	8011578946647	2,75

276A ADATTATORE PER INSERTI mm 10
 ADAPTER FOR BITS mm 10



Icona	Modello	Spessore	Lunghezza	Spessore	Quantità	Barcode	Prezzo
	0276.004	F 3/8"	M 10 mm.28	28	6	8011578947088	4,20
	0276.006	F 1/2"	M 10 mm.50	50	6	8011578947101	5,65

276 CASSETTA 40 INSERTI ESAGONO-TORX-XZN 10 mm 3/8" - 1/2" - acciaio chrom-vanadium
 SET 40 BITS HEX-TORX-XZN 10 mm 3/8" - 1/2" chrom-vanadium steel

3/8" 1/2"

Contenuto-content:

0276.004	0272.050	0272.020
0276.006	0272.055	0272.025
0270.040	0274.005	0272.030
0270.050	0274.006	0272.040
0270.060	0274.008	0272.045
0270.070	0274.010	0272.050
0270.080	0274.012	0272.055
0270.100	0271.040	0274.005
0270.120	0271.050	0274.006
0272.020	0271.060	0274.008
0272.025	0271.070	0274.010
0272.030	0271.080	0274.012
0272.040	0271.100	
0272.045	0271.120	



Icona	Modello	Spessore	Lunghezza	Spessore	Quantità	Barcode	Prezzo
	0276.010	330 x 130 x 40		1700	1	8011578947125	54,00



278 CHIAVE A BUSSOLA ESAGONALE LAMA FLESSIBILE CON IMPUGNATURA
 HEXAGONAL SOCKET WITH FLEXIBLE BLADE WITH HANDLE



Icona	Ø X	L	L	L	W	W	Barcode	€
	7,0	170	105 x 30	150	6	6	8011578907457	7,40
	8,0	170	105 x 30	150	6	6	8011578907488	7,40
	10,0	170	105 x 30	154	6	6	8011578907549	7,40

303A SPUNTONE - punta quadra - impugnatura acetato
 PUNCH - square tip - acetate handle

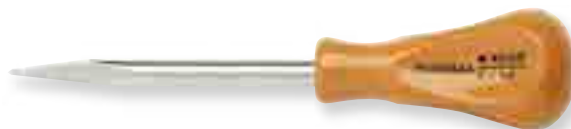

Icona	Ø X	L	L	W	W	Barcode	€
	8 x125	75 x 37	89	12	12	8011578907907	4,35

303B SPUNTONE - punta tonda - impugnatura acetato
 PUNCH - round tip - acetate handle



Icona	Ø X	L	L	W	W	Barcode	€
	8 x125	75 x 37	90	12	12	8011578907938	4,35

304A PUNTERUOLO - punta quadra - impugnatura acetato
 PUNCH - square tip - acetate handle



Icona	Ø X	L	L	W	W	Barcode	€
	6 x 90	102 x 24	65	12	12	8011578907969	3,80

304B PUNTERUOLO - punta tonda - impugnatura acetato
 PUNCH - round tip - acetate handle







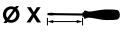

Icona	Ø X	L	L	W	W	Barcode	€
	6 x 90	102 x 24	62	12	12	8011578907990	3,80

305A PUNTERUOLO - punta quadra - impugnatura acetato

PUNCH - square tip - acetate handle













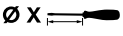



0305.110 4 x 65 93 x 21 36 12 8011578908027 € 3,05

305B PUNTERUOLO - punta tonda - impugnatura acetato

PUNCH - round tip - acetate handle













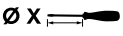



0305.210 4 x 65 93 x 21 37 12 8011578908058 € 3,05

307 LEVACHIODI PER LEVASEMENZE - impugnatura acetato

NAILS PULLER - acetate handle













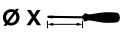



0307.010 6 x 70 102 x 24 66 12 8011578908089 € 8,65

310 LEVACHIODI PER CALZOLAI - impugnatura acetato

NAILS PULLER FOR SHOEMAKERS - acetate handle

















0310.010 8 x 80 98 x 35 116 12 8011578908119 € 9,90

311 LEVACHIODI PER TAPPEZZIERI - impugnatura acetato

NAILS PULLER FOR UPHOLSTERERS - acetate handle

















0311.010 95 98 x 35 139 12 8011578908140 € 13,40

313 LEVAPUNTI - impugnatura acetato

PULLER - acetate handle



0313.010 80 98 x 35 132 12 8011578908171 € 10,60

316 CHIAVE A BUSSOLA CON IMPUGNATURA ACETATO - acciaio chrom-vanadium
 SOCKET WITH ACETATE HANDLE - chrom-vanadium steel



DIN 3125

Icona	Dimensione	Lunghezza	Spessore	Quantità	Barcode	Prezzo
	4,0 x 80	102 x 24	48	6	8011578908201	5,30
	5,0 x 80	102 x 24	48	6	8011578908232	5,30
	5,5 x 80	102 x 24	48	6	8011578908263	5,30
	6,0 x 80	102 x 24	66	6	8011578908294	5,30
	7,0 x 80	102 x 24	111	6	8011578908324	5,70
	8,0 x 80	102 x 24	111	6	8011578908355	5,90
	9,0 x 80	102 x 24	111	6	8011578908386	6,00
	10,0 x 80	114 x 28	116	6	8011578908416	6,40
	11,0 x 80	114 x 28	122	6	8011578908447	6,55
	12,0 x 80	114 x 28	138	6	8011578908478	6,90
	13,0 x 80	114 x 28	143	6	8011578908508	7,40
	14,0 x 80	114 x 28	133	6	8011578908539	7,55



318 CHIAVE A BUSSOLA CON IMPUGNATURA ACETATO - foro profondo - acciaio chrom-vanadium
 SOCKET WITH ACETATE HANDLE - deep hole - chrom-vanadium steel

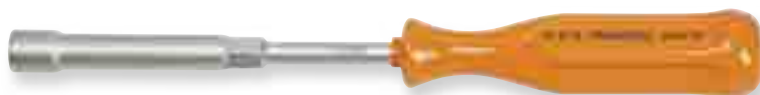

Icona	Dimensione	Lunghezza	Spessore	Quantità	Barcode	Prezzo
	5,0 x 115	114 x 28	112	6	8011578947149	6,10
	5,5 x 115	114 x 28	110	6	8011578947163	6,10
	6,0 x 115	114 x 28	110	6	8011578943561	6,30
	7,0 x 115	114 x 28	104	6	8011578908591	7,70
	8,0 x 115	114 x 28	135	6	8011578908621	7,70
	9,0 x 115	114 x 28	114	6	8011578908652	7,90
	10,0 x 115	114 x 28	161	6	8011578908683	8,70
	11,0 x 115	114 x 28	150	6	8011578943684	8,80
	12,0 x 115	114 x 28	132	6	8011578947200	9,00
	13,0 x 115	114 x 28	208	6	8011578908713	9,00
	14,0 x 115	114 x 28	148	6	8011578947224	9,20



82 CHIAVE A BUSSOLA ESAGONO FORO PROFONDO
 DEEP HOLE HEXAGON SOCKET



Icona	Dimensione	Lunghezza	Spessore	Quantità	Barcode	Prezzo
	5,0 x 37 x 150	117 x 34	118	6	8011578952310	8,55
	5,5 x 37 x 150	117 x 34	118	6	8011578952341	8,55
	6,0 x 37 x 150	117 x 34	118	6	8011578952372	8,55
	7,0 x 72 x 150	117 x 34	136	6	8011578952402	9,55
	8,0 x 72 x 150	117 x 34	126	6	8011578952433	10,30
	9,0 x 72 x 150	117 x 34	128	6	8011578952464	10,90
	10,0 x 72 x 150	117 x 34	126	6	8011578952495	10,90
	11,0 x 72 x 150	117 x 34	158	6	8011578952525	11,65
	12,0 x 72 x 150	117 x 34	146	6	8011578952556	11,65
	13,0 x 72 x 150	117 x 34	152	6	8011578952587	12,25
	14,0 x 72 x 150	117 x 34	152	6	8011578952617	12,25 new



78
CHIAVE MASCHIO ESAGONALE SFERICA
 SPHERICAL HEXAGONAL MALE WRENCH

HRC 60

Icona	Ø X	Immagine	Immagine	Immagine	Immagine	Barcode	€
	0078.025 2,5 x 75		87,5 x 25,4	28	6	8011578952082	2,75
	0078.030 3,0 x 75		87,5 x 25,4	28	6	8011578952105	2,75
	0078.040 4,0 x 100		109 x 31,7	60	6	8011578952136	3,80
	0078.050 5,0 x 100		109 x 31,7	70	6	8011578952167	3,80
	0078.060 6,0 x 125		117 x 34,0	94	6	8011578952198	5,10

**340**
CHIAVE MASCHIO ESAGONALE CON IMPUGNATURA ACETATO - acciaio chrom-vanadium finitura brunita
 HEXAGONAL MALE WRENCH WITH ACETATE HANDLE - chrom-vanadium steel burnished finish

Icona	Ø X	Immagine	Immagine	Immagine	Immagine	Barcode	€
	0340.015 1,5 x 70		77 x 21	20	6	8011578943066	2,35
	0340.020 2,0 x 70		77 x 21	22	6	8011578908928	2,35
	0340.025 2,5 x 80		77 x 21	23	6	8011578908959	2,35
	0340.030 3,0 x 100		77 x 21	26	6	8011578908980	2,35
	0340.040 4,0 x 100		91 x 25	47	6	8011578909017	2,70
	0340.050 5,0 x 120		91 x 25	65	6	8011578909048	3,05
	0340.060 6,0 x 120		106 x 30	98	6	8011578909079	4,00
	0340.080 8,0 x 120		115 x 34	182	6	8011578909109	5,40

**340A**
SERIE 5 CHIAVI MASCHIO CON IMPUGNATURA ACETATO - cartone
 SET 5 MALE WRENCHES WITH ACETATE HANDLE - box

Contenuto-content:

0340.020 2
 0340.030 3
 0340.040 4
 0340.050 5
 0340.060 6

Icona	Immagine	Immagine	Immagine	Barcode	€
				8011578340193	16,65

**341**
CHIAVE MASCHIO QUADRATA CON IMPUGNATURA ACETATO - acciaio chrom-vanadium finitura cromata punta nera
 SQUARE MALE WRENCH WITH ACETATE HANDLE - chrom-vanadium steel chrome plated black finished tip

Icona	Ø X	Immagine	Immagine	Immagine	Immagine	Barcode	€
	0341.100 SQ 1-4 x 100		91 x 25	61	12	8011578909161	3,45
	0341.200 SQ 2-5 x 125		106 x 30	89	12	8011578909192	4,00
	0341.300 SQ 3-6 x 150		106 x 30	98	12	8011578909222	4,15

**75**
GIRAVITE PER VITI TORX CON FORO
 SCREWDRIVER FOR TORX WITH HOLE HEAD SCREWS

HRC 60

Icona	Ø X	Immagine	Immagine	Immagine	Immagine	Barcode	€
	0075.060 TX 6 x 60		87,5 x 25,4	28	6	8011578951740	3,70
	0075.070 TX 7 x 60		87,5 x 25,4	28	6	8011578951771	3,70
	0075.080 TX 8 x 80		87,5 x 25,4	30	6	8011578951801	3,70
	0075.090 TX 9 x 80		109 x 31,7	56	6	8011578951832	4,35
	0075.100 TX 10 x 80		109 x 31,7	58	6	8011578951863	4,45
	0075.150 TX 15 x 80		109 x 31,7	60	6	8011578951894	4,45
	0075.200 TX 20 x 100		109 x 31,7	62	6	8011578951924	4,60
	0075.250 TX 25 x 100		109 x 31,7	70	6	8011578951955	4,95
	0075.270 TX 27 x 100		109 x 31,7	66	6	8011578951986	4,95
	0075.300 TX 30 x 100		117 x 34,0	88	6	8011578952013	6,50
	0075.400 TX 40 x 125		127 x 36,9	138	6	8011578952044	8,80
	0075.450 TX 45 x 125		127 x 36,9	138	6	8011578952075	8,80



343 CHIAVE PER VITI TORX CON IMPUGNATURA ACETATO - acciaio chrom-vanadium finitura cromata punta nera
WRENCH FOR TORX-HEAD SCREWS WITH ACETATE HANDLE - chrom-vanadium steel chrome plated black finished tip

Model	Size	Length	Width	Weight	Barcode	Price
0343.060	TX 6 x 70	77 x 21	24	6	8011578909550	2,30
0343.070	TX 7 x 70	77 x 21	24	6	8011578909581	2,30
0343.080	TX 8 x 80	77 x 21	22	6	8011578909611	2,40
0343.090	TX 9 x 80	77 x 21	27	6	8011578909642	2,45
0343.100	TX 10 x 80	77 x 21	28	6	8011578909673	2,60
0343.150	TX 15 x 100	91 x 25	46	6	8011578909703	2,95
0343.200	TX 20 x 100	91 x 25	48	6	8011578909734	2,95
0343.250	TX 25 x 100	91 x 25	56	6	8011578909765	3,55
0343.270	TX 27 x 120	106 x 30	84	6	8011578909796	3,70
0343.300	TX 30 x 120	106 x 30	96	6	8011578909826	4,40
0343.400	TX 40 x 140	115 x 34	150	6	8011578909857	4,80
0343.450	TX 45 x 140	115 x 34	151	6	8011578909888	4,95

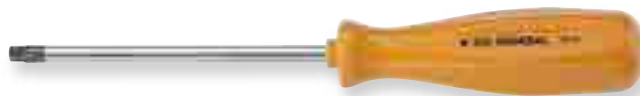

343D SERIE 5 CHIAVI TORX CON IMPUGNATURA ACETATO - cartone
SET 5 TORX WRENCHES WITH ACETATE HANDLE - box

Contenuto-content:

0343.100	TX 10 x 80	0343.250	TX 25 x 100
0343.150	TX 15 x 100	0343.300	TX 30 x 120
0343.200	TX 20 x 100		

Model	Dimensions	Weight	Barcode	Price
0343.490	310 x 180 x 37	423	8011578343279	19,00



343H CHIAVE PER VITI TORX CON FORO CON IMPUGNATURA ACETATO - acc. chrom-vanadium fin. cromata punta nera
WRENCH TORX HEAD SCREWS WITH HOLE WITH ACETATE HANDLE - chrom-vanadium steel chrome plated black fin. tip

Model	Size	Length	Width	Weight	Barcode	Price
0343.605	TX 5 x 60	77 x 21	24	6	8011578933708	3,15
0343.606	TX 6 x 60	77 x 21	26	6	8011578933722	3,15
0343.607	TX 7 x 60	77 x 21	24	6	8011578933746	3,15
0343.608	TX 8 x 60	77 x 21	24	6	8011578933760	3,15
0343.609	TX 9 x 60	77 x 21	23	6	8011578909970	3,15
0343.610	TX 10 x 80	77 x 21	29	6	8011578910006	3,25
0343.615	TX 15 x 80	91 x 25	46	6	8011578910037	3,60
0343.620	TX 20 x 100	91 x 25	48	6	8011578910068	3,60
0343.625	TX 25 x 100	91 x 25	56	6	8011578910099	4,25
0343.627	TX 27 x 115	106 x 30	83	6	8011578910129	4,40
0343.630	TX 30 x 115	106 x 30	96	6	8011578910150	5,05
0343.640	TX 40 x 130	115 x 34	152	6	8011578910181	5,50

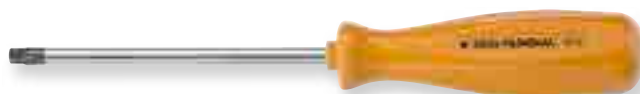

343HT SERIE 5 CHIAVI TORX CON FORO CON IMPUGNATURA ACETATO - cartone
SET 5 WRENCHES FOR TORX HEAD SCREWS WITH HOLE WITH ACETATE HANDLE - box

Contenuto-content:

0343.610	TX 10	0343.625	TX 25
0343.615	TX 15	0343.630	TX 30
0343.620	TX 20		

Model	Dimensions	Weight	Barcode	Price
0343.690	310 x 180 x 37	425	8011578343774	22,30



343TT ESPOSITORE 57 CHIAVI TORX - con foro
DISPLAY STAND 57 TORX WRENCHES - with hole

Contenuto-content:

0343.606	TX 6	Nr. 5	0343.620	TX 20	Nr. 5
0343.607	TX 7	Nr. 5	0343.625	TX 25	Nr. 5
0343.608	TX 8	Nr. 5	0343.627	TX 27	Nr. 5
0343.609	TX 9	Nr. 5	0343.630	TX 30	Nr. 4
0343.610	TX 10	Nr. 5	0343.640	TX 40	Nr. 4
0343.615	TX 15	Nr. 5	0343.450	TX 45	Nr. 4

Model	Dimensions	Weight	Barcode	Price
0343.710	410 x 230 x 200	10200	8011578343798	220,50



344 CHIAVE MASCHIO ESAGONALE CON IMPUGNATURA A "T" BICOMPONENTE - acciaio chrom-vanadium finitura cromata
HEXAGONAL MALE WRENCH WITH "T" BICOMPONENT HANDLE - chrom-vanadium steel chrome plated finish



Icona	Ø	X	Icona	Icona	Icona	Icona	Barcode	€
	0344.020	2,0 x 100	140 x 65	14	6	8011578910242	3,25	
	0344.025	2,5 x 100	140 x 65	14	6	8011578910273	3,40	
	0344.030	3,0 x 100	145 x 65	22	6	8011578910303	3,55	
	0344.040	4,0 x 150	210 x 90	57	6	8011578910365	3,95	
	0344.050	5,0 x 150	210 x 90	72	6	8011578910426	4,50	
	0344.060	6,0 x 150	210 x 90	88	6	8011578910457	5,20	
	0344.080	8,0 x 160	230 x 115	178	6	8011578910518	6,10	
	0344.100	10,0 x 180	260 x 120	268	6	8011578910570	8,80	



344A SERIE 7 CHIAVI ESAGONO A "T"
SET 7 HEXAGON WRENCHES "T" HANDLE

Contenuto-content:

0344.020	2	0344.050	5
0344.025	2,5	0344.060	6
0344.030	3	0344.080	8
0344.040	4		

Icona	Icona	Icona	Barcode	€
	0344.110	370 x 210 x 40	8011578960742	33,90



344X CHIAVE MASCHIO TORX CON IMPUGNATURA A "T"
TORX WRENCH WITH "T" HANDLE

Icona	Icona	X	Icona	Icona	Icona	Icona	Barcode	€
	0344.206	TX 6 x 100	140 x 65	22	6	8011578933784	3,30	
	0344.207	TX 7 x 100	140 x 65	22	6	8011578933807	3,30	
	0344.208	TX 8 x 100	140 x 65	22	6	8011578933821	3,30	
	0344.209	TX 9 x 100	140 x 65	22	6	8011578933845	3,30	
	0344.210	TX 10 x 100	140 x 65	22	6	8011578933869	3,40	
	0344.215	TX 15 x 100	140 x 65	27	6	8011578933883	3,55	
	0344.220	TX 20 x 100	160 x 90	50	6	8011578933906	3,95	
	0344.225	TX 25 x 150	210 x 95	61	6	8011578933920	4,75	
	0344.227	TX 27 x 150	210 x 95	69	6	8011578933944	5,05	
	0344.230	TX 30 x 150	210 x 95	77	6	8011578933968	5,20	
	0344.240	TX 40 x 200	260 x 95	120	6	8011578933982	6,95	



344XT SERIE 7 CHIAVI TORX A "T"
SET 7 TORX WRENCHES "T" HANDLE

Contenuto-content:

0344.206	TX 6	0344.220	TX 20
0344.208	TX 8	0344.225	TX 25
0344.210	TX 10	0344.230	TX 30
0344.215	TX 15		

Icona	Icona	Icona	Barcode	€
	0344.280	370 x 210 x 40	8011578344580	31,40



344F

CHIAVE TRE ESTREMITÀ ASTA SCORREVOLE MASCHIO ESAGONALI - acc. chrom-vanadium fin. cromata punte nere
HEXAGONAL MALE THREE ENDS WRENCH SLIDING BAR - chrom-vanadium steel chrome plated black finished tips

Pro
INDUSTRIAL



scorrevole
sliding

Icona	Ø	L	Icona	Q	Barcode	€
	2,0	65 x 130		22	6 8011578910600	10,00
	2,5	65 x 130		22	6 8011578910631	10,00
	3,0	65 x 130		22	6 8011578910662	10,10
	4,0	90 x 180		64	6 8011578910723	11,00
	5,0	90 x 180		66	6 8011578910785	11,35
	6,0	105 x 215		134	6 8011578910815	13,00
	8,0	125 x 250		224	2 8011578910877	16,70
	10,0	145 x 300		382	2 8011578910938	19,45
	12,0	165 x 315		575	2 8011578910969	24,55
	14,0	170 x 340		822	2 8011578910990	29,85



344FZ

SERIE 6 CHIAVI ESAGONO TRE TESTE - cartone
SET 6 HEXAGON THREE HEADS WRENCHES - box



Contenuto - content:

0344.320 mm 2	0344.340 mm 4
0344.325 mm 2,5	0344.350 mm 5
0344.330 mm 3	0344.360 mm 6

Icona	L	Icona	Barcode	€
	370 x 210 x 40		546 8011578344924	69,40



344FT

SERIE 10 CHIAVI ESAGONO TRE TESTE
SET 10 T HEXAGON THREE HEADS WRENCHES



Contenuto - content:

0344.320 mm 2	0344.360 mm 6
0344.325 mm 2,5	0344.380 mm 8
0344.330 mm 3	0344.391 mm 10
0344.340 mm 4	0344.392 mm 12
0344.350 mm 5	0344.394 mm 14

Icona	Q	Barcode	€
	2334	8011578344948	156,00



344T CHIAVE TRE TESTE TORX ASTA SCORREVOLE
 TORX THREE HEADS WRENCH SLIDING BAR



Icona	Modello	Dimensioni	Quantità	Barra	Barcode	Prezzo
	0344.406 TX 6	65 x 125	22	6	8011578943226	11,60
	0344.407 TX 7	65 x 125	22	6	8011578943240	11,60
	0344.408 TX 8	65 x 125	22	6	8011578943264	11,60
	0344.409 TX 9	65 x 125	23	6	8011578943288	11,60
	0344.410 TX 10	65 x 125	23	6	8011578943301	11,60
	0344.415 TX 15	65 x 125	23	6	8011578943325	11,60
	0344.420 TX 20	65 x 125	23	6	8011578943349	11,60
	0344.425 TX 25	90 x 180	66	6	8011578943363	12,95
	0344.427 TX 27	90 x 180	66	2	8011578943387	12,95
	0344.430 TX 30	90 x 180	66	2	8011578943400	12,95
	0344.440 TX 40	105 x 210	138	2	8011578943424	16,35
	0344.445 TX 45	105 x 210	138	2	8011578943448	16,35



344TZ SERIE 6 CHIAVI TRE TESTE TORX - cartone
 SET 6 TORX THREE HEADS WRENCHES - box

Contenuto-content:

- 0344.408 TX 8
- 0344.410 TX 10
- 0344.415 TX 15
- 0344.420 TX 20
- 0344.425 TX 25
- 0344.430 TX 30

Icona	Dimensioni	Quantità	Barcode	Prezzo
	310 x 180 x 37	435	8011578344962	76,25



344TX SERIE 12 CHIAVI TRE TESTE TORX
 SET 12 TORX THREE HEADS WRENCHES

Contenuto-content:

- 0344.406 TX 6 0344.420 TX 20
- 0344.407 TX 7 0344.425 TX 25
- 0344.408 TX 8 0344.427 TX 27
- 0344.409 TX 9 0344.430 TX 30
- 0344.410 TX 10 0344.440 TX 40
- 0344.415 TX 15 0344.445 TX 45

Icona	Quantità	Barcode	Prezzo
	620	8011578344986	152,75



344 ESPOSITORE 66 CHIAVI A "T"
 DISPLAY STAND 66 "T" WRENCHES

Contenuto-content:

0344.020 2,0	Nr. 3	0344.215 TX 15	Nr. 3	0344.360 6,0	Nr. 3
0344.025 2,5	Nr. 3	0344.220 TX 20	Nr. 3	0344.380 8,0	Nr. 3
0344.030 3,0	Nr. 3	0344.225 TX 25	Nr. 3	0344.410 TX 10	Nr. 3
0344.040 4,0	Nr. 3	0344.320 2,0	Nr. 3	0344.415 TX 15	Nr. 3
0344.050 5,0	Nr. 3	0344.325 2,5	Nr. 3	0344.420 TX 20	Nr. 3
0344.060 6,0	Nr. 3	0344.330 3,0	Nr. 3	0344.425 TX 25	Nr. 3
0344.080 8,0	Nr. 3	0344.340 4,0	Nr. 3		
0344.210 TX 10	Nr. 3	0344.350 5,0	Nr. 3		

Icona	Dimensioni	Quantità	Barcode	Prezzo	Note
	490 x 400	5000	8011578981884	526,50	new
	vuoto - empty	1000	8011578985127	55,00	new



345 CHIAVE MASCHIO ESAGONALE - professionale - acciaio chrom-vanadium finitura cromata
HEXAGONAL MALE WRENCH - professional - chrom vanadium steel chrome plated

Icona	Ø	l-L	Icona	Icona	Barcode	€	Pro INDUSTRIAL	DIN ISO 2936
	0345.015	1,5	45 x 14	2	12	8011578911027	0,50	
	0345.020	2,0	50 x 16	3	12	8011578911058	0,60	
	0345.025	2,5	56 x 18	4	12	8011578911089	0,65	
	0345.030	3,0	63 x 20	5	12	8011578911119	0,70	
	0345.035	3,5	66 x 22	7	12	8011578911140	0,75	
	0345.040	4,0	70 x 25	10	12	8011578911171	0,85	
	0345.045	4,5	70 x 25	10	12	8011578911201	0,90	new
	0345.050	5,0	80 x 28	18	12	8011578911232	1,00	
	0345.055	5,5	80 x 28	18	12	8011578911263	1,10	new
	0345.060	6,0	90 x 32	30	12	8011578911294	1,15	
	0345.070	7,0	95 x 34	42	12	8011578911324	1,40	
	0345.080	8,0	100 x 36	61	12	8011578911355	1,75	
	0345.090	9,0	100 x 36	76	12	8011578911386	2,35	
	0345.100	10,0	112 x 40	106	12	8011578911416	2,55	
	0345.120	12,0	125 x 45	172	12	8011578911447	4,50	
	0345.130	13,0	130 x 45	225	12	8011578911478	5,25	
	0345.140	14,0	140 x 56	264	6	8011578911508	6,20	
	0345.170	17,0	160 x 63	443	6	8011578911539	11,50	
	0345.190	19,0	180 x 70	600	6	8011578911560	15,20	
	0345.220	22,0	230 x 110	932	2	8011578934026	22,40	
	0345.240	24,0	235 x 110	1193	2	8011578934040	28,55	
	0345.270	27,0	240 x 110	1300	2	8011578974923	33,20	



345.7 CHIAVE MASCHIO ESAGONALE in POLLICI - professionale - acciaio chrom-vanadium finitura cromata
HEXAGONAL MALE WRENCH in INCH - professional - chrom vanadium steel chrome plated

Icona	Ø	l-L	Icona	Icona	Barcode	€	Pro INDUSTRIAL	DIN ISO 2936
	0345.705	1/16"	14 x 45	2		8011578977269	0,75	
	0345.708	3/32"	70 x 25	2		8011578986087	0,85	
	0345.710	1/8"	70 x 25	5		8011578977306	0,95	
	0345.712	5/32"	73 x 28	10		8011578977320	1,25	
	0345.715	3/16"	85 x 33	17		8011578977344	1,35	
	0345.718	7/32"	35 x 93	18		8011578977368	1,50	
	0345.720	1/4"	38 x 96	30		8011578977382	1,90	
	0345.723	5/16"	44 x 110	61		8011578977405	2,10	
	0345.725	3/8"	50 x 122	100		8011578977429	2,35	



POLLICI
INCH

Serie 9 chiavi pollici - Set 9 inch wrenches

0345.799 8011578977443 14,30

345Z CHIAVE MASCHIO ESAGONO professionale tipo LUNGO - acciaio chrom-vanadium finitura cromata
HEXAGONAL MALE WRENCH PROFESSIONAL LONG TYPE - chrom vanadium steel chrome plated

Icona	Ø	l-L	Icona	Icona	Barcode	€	Pro INDUSTRIAL
	0345.920	2.0	16 x 100	4	12	8011578974947	0,70
	0345.925	2.5	18 x 112	5	12	8011578974961	0,75
	0345.930	3.0	20 x 127	5	12	8011578974985	0,85
	0345.940	4.0	25 x 141	12	12	8011578975005	1,00
	0345.950	5.0	28 x 161	19	12	8011578975029	1,40
	0345.960	6.0	32 x 181	25	12	8011578975043	1,70
	0345.980	8.0	36 x 200	64	12	8011578975067	2,80
	0345.981	10.0	40 x 226	110	12	8011578975081	4,40



346 SERIE 7 CHIAVI MASCHIO ESAGONALE - clip in plastica
SET 7 HEXAGONAL MALE WRENCHES - plastic clip

Contenuto-content:
0345.015 1,5 0345.025 2,5 0345.040 4 0345.060 6
0345.020 2 0345.030 3 0345.050 5

Icona	Icona	Barcode	€	Pro INDUSTRIAL
	0346.070	94 6 8011578346003	6,25	



347 SERIE 9 CHIAVI MASCHIO ESAGONALE - clip in plastica
 SET 9 HEXAGONAL MALE WRENCHES - plastic clip









Contenuto-content:

0345.015	1,5	0345.030	3	0345.060	6
0345.020	2	0345.040	4	0345.080	8
0345.025	2,5	0345.050	5	0345.100	10

 **0347.090**    €   **10,50**



350 CHIAVE MASCHIO ESAGONALE LUNGA ESTREMITÀ SFERICA - acciaio chrom-vanadium
 LONG SPHERICAL END HEXAGONAL MALE WRENCH - chrom-vanadium steel

						€		
0350.015	1,5	80 x 16	2	6	8011578934064	0,90		
0350.020	2,0	83 x 16	3	6	8011578911652	1,10		
0350.025	2,5	93 x 20	5	6	8011578911683	1,20		
0350.030	3,0	98 x 20	8	6	8011578911713	1,25		
0350.040	4,0	110 x 30	12	6	8011578911744	1,50		
0350.050	5,0	123 x 38	25	6	8011578911775	1,70		
0350.060	6,0	140 x 38	41	6	8011578911805	2,10		
0350.080	8,0	156 x 36	85	6	8011578911867	2,90		
0350.100	10,0	170 x 40	142	6	8011578911898	3,50		



351 SERIE 9 CHIAVI ESAGONALI LUNGHE ESTREMITÀ SFERICA - clip in plastica
 SET 9 LONG SPHERICAL END HEXAGONAL WRENCHES - plastic clip









Contenuto-content:

0350.015	1,5	0350.030	3	0350.060	6
0350.020	2	0350.040	4	0350.080	8
0350.025	2,5	0350.050	5	0350.100	10

 **0351.090**    €   **15,30**



352 SERIE 9 CHIAVI ESAGONALI LUNGHE ESTREMITÀ SFERICA - clip in plastica - EXTRA LUNGA
 SET 9 EXTRA LONG SPHERICAL END HEXAGONAL WRENCHES - plastic clip - EXTRA LONG

								
Contenuto-content:								
0352.010	1,5 x 90	0352.030	3 x 130	0352.060	6 x 190			
0352.020	2 x 105	0352.040	4 x 145	0352.080	8 x 210			
0352.025	2,5 x 110	0352.050	5 x 165	0352.100	10 x 230			
 0352.090	 410	 6		€			19,55	



353 SERIE 9 CHIAVI ESAGONALI LUNGHE ESTREMITÀ SFERICA - MULTICOLOR - acciaio chrom-vanadium-molibdeno
 SET 9 EXTRA LONG SPHERICAL END HEXAGONAL WRENCHES - MULTICOLOR - chrom-vanadium-molybdenum steel

								
Contenuto-content:								
0353.015	1,5	0353.030	3	0353.060	6			
0353.020	2	0353.040	4	0353.080	8			
0353.025	2,5	0353.050	5	0353.100	10			
 0353.090	 385	 6		€			18,30 new	



355 CHIAVE MASCHIO ESAGONO tipo STANDARD - acciaio carbonio temperato - finitura zincata
 HEXAGONAL MALE WRENCH - type STANDARD - carbon steel hardness - zinc finish



Icona	Ø	—L—	Uomo	Scatola	Barcode	€	Standard
	2,0	50 x 16	3	12	8011578911959	0,20	DIN 911 - UNI 6753
	2,5	56 x 18	4	12	8011578911980	0,20	
	3,0	63 x 20	5	12	8011578912017	0,20	
	4,0	70 x 25	11	12	8011578912079	0,40	
	5,0	80 x 28	18	12	8011578912130	0,60	
	6,0	90 x 32	23	12	8011578912192	0,80	
	8,0	100 x 36	60	12	8011578912253	1,30	
	10,0	112 x 40	103	12	8011578912314	2,20	

confezione in scatolone - packaging in parcel:

Icona	Ø	—L—	Uomo	Scatola	Barcode	(richiedi prezzo per quantità) (ask price for quantity)
	2,0	50 x 16	2000	1000	8011578972844	
	2,5	56 x 18	3200	1000	8011578972967	
	3,0	63 x 20	5000	1000	8011578972981	
	4,0	70 x 25	10300	1000	8011578973001	
	5,0	80 x 28	18500	1000	8011578973025	
	6,0	90 x 32	15000	500	8011578973049	
	8,0	100 x 36	12000	200	8011578973063	
	10,0	112 x 40	10500	100	8011578973087	



355.8 CHIAVE PER VITI TORX - tipo STANDARD - acciaio carbonio temperato - finitura zincata
 TORX WRENCH - STANDARD type - carbon steel hardness - zinc finish



Icona	Ø	—L—	Uomo	Scatola	Barcode	€	Standard
	TX 8	55 x 20	3	12	8011578982508	0,75	DIN 911 - UNI 6753
	TX 10	55 x 20	4	12	8011578982560	0,80	new
	TX 15	57 x 21	5	12	8011578982621	0,85	new
	TX 20	60 x 22	7	12	8011578982683	0,95	new

confezione in scatolone - packaging in parcel:

Icona	Ø	—L—	Uomo	Scatola	Barcode	(richiedi prezzo per quantità)
	TX 8	55 x 20	3000	1000	8011578982522	new
	TX 10	55 x 20	4000	1000	8011578982584	new
	TX 15	57 x 21	5000	1000	8011578982645	new
	TX 20	60 x 22	7000	1000	8011578982706	new



356 SERIE 6 CHIAVI ESAGONO
 SET 6 HEXAGON WRENCHES

Contenuto-content: (2 - 2,5 - 3 - 4 - 5 - 6)

Icona	Uomo	Scatola	Barcode	€	Standard
	189	6	8011578912345	7,90	



357 SERIE 6 CHIAVI TORX
 SET 6 TORX WRENCHES

Contenuto-content: (TX 10 - 15 - 20 - 25 - 27 - 30)

Icona	Uomo	Scatola	Barcode	€	Standard
	92	6	8011578357016	8,00	



360 CHIAVE PER VITI TORX - acciaio chrom-vanadium
 WRENCH FOR TORX HEAD SCREWS - chrom-vanadium steel

Icona	Modello	Dimensioni	Quantità	Prezzo	Barcode	Prezzo	Icona
	0360.060 TX 6	42 x 16	2	6	8011578912406	1,00	
	0360.070 TX 7	48 x 16	3	6	8011578912437	1,00	
	0360.080 TX 8	48 x 16	3	6	8011578912468	1,00	
	0360.090 TX 9	48 x 16	3	6	8011578912499	1,00	
	0360.100 TX 10	51 x 17	4	6	8011578912529	1,40	
	0360.150 TX 15	54 x 18	5	6	8011578912550	1,50	
	0360.200 TX 20	62 x 19	7	6	8011578912581	1,70	
	0360.250 TX 25	60 x 20	10	6	8011578912611	1,80	
	0360.270 TX 27	64 x 21	13	6	8011578912642	1,90	
	0360.300 TX 30	70 x 24	20	6	8011578912673	1,95	
	0360.400 TX 40	76 x 26	30	6	8011578912703	2,00	
	0360.450 TX 45	82 x 28	43	6	8011578912734	2,50	
	0360.500 TX 50	105 x 42	64	6	8011578934088	2,80	



362 SERIE 9 CHIAVI TORX - clip in plastica
 SET 9 TORX WRENCHES - plastic clip

Contenuto-content:

0360.100	10	0360.300	30
0360.150	15	0360.400	40
0360.200	20	0360.450	45
0360.250	25	0360.500	50
0360.270	27		

Icona	Modello	Quantità	Prezzo	Barcode	Prezzo	Icona
	0362.090	284	6	8011578362010	12,60	



365 CHIAVE PER VITI TORX LUNGHE - acciaio chrom-vanadium
 WRENCH FOR LONG TORX HEAD SCREWS - chrom-vanadium steel

Icona	Modello	Dimensioni	Quantità	Prezzo	Barcode	Prezzo	Icona
	0365.080 TX 8	14 x 77	5	12	8011578982744	1,05 new	
	0365.100 TX 10	14 x 77	5	12	8011578982782	1,45 new	
	0365.150 TX 15	16 x 84	6	12	8011578982829	1,55 new	
	0365.200 TX 20	18 x 92	8	12	8011578982867	1,75 new	



366 SERIE 9 CHIAVI TORX CON FORO LUNGHE - clip in plastica
 SET 9 LONG TORX WRENCHES WITH HOLE - plastic clip

Contenuto-content:

0365.100	10	75 x 17	0365.300	30	125 x 29
0365.150	15	83 x 18	0365.400	40	140 x 37
0365.200	20	92 x 19	0365.450	45	150 x 37
0365.250	25	100 x 20	0365.500	50	170 x 42
0365.270	27	110 x 25			

Icona	Modello	Quantità	Prezzo	Barcode	Prezzo
	0366.090	346	6	8011578366018	16,75



367 SERIE 9 CHIAVI TORX LUNGHE - MULTICOLOR - acciaio chrom-vanadium-molibdeno
 SET 9 TORX WRENCHES - MULTICOLOR - chrom-vanadium-molybdenum steel

Contenuto-content:

0367.010	10	0367.025	25	0367.040	40
0367.015	15	0367.027	27	0367.045	45
0367.020	20	0367.030	30	0367.050	50

Icona	Modello	Quantità	Prezzo	Barcode	Prezzo
	0367.090	350	6	8011578982904	19,45 new



370 MAZZUOLA TESTE IN POLIURETANO - manico legno
 Mallet with polyurethane head - wooden handle

UNI 7784

Icona	Ø	L	Peso	Icona	Barcode	€
					811578 000004	
0370.022	22	250	168	4	8011578912826	16,90
0370.028	28	280	263	4	8011578912857	19,10
0370.035	35	310	408	4	8011578912888	22,80
0370.042	42	320	610	4	8011578912918	28,00
0370.050	50	360	954	2	8011578912949	37,00
0370.060	60	380	1402	2	8011578912970	48,50



371 RICAMBI PER MAZZUOLA - poliuretano
 Spare for mallet - polyurethane

Icona	Ø	Peso	Icona	Barcode	€
				811578 000004	
0371.022	22	12	6	8011578913007	3,60
0371.028	28	34	6	8011578913038	4,40
0371.035	35	60	6	8011578913069	5,40
0371.042	42	90	6	8011578913090	7,90
0371.050	50	124	6	8011578913120	11,00
0371.060	60	200	6	8011578913151	14,60

alla coppia - in couple



372 MAZZUOLA GOMMA NERA - manico legno antisfilamento
 Black rubber mallet - wooden handle no-unthreading

DIN 5128

Icona	Gr.	Ø	L	Peso	Icona	Barcode	€
						811578 000004	
0372.030	300	50	320	382	4	8011578913182	6,50
0372.050	500	60	340	570	4	8011578913212	7,65
0372.080	800	70	380	862	2	8011578913243	10,70



373 MAZZUOLA GOMMA BIANCA - manico legno antisfilamento
 White rubber mallet - wooden handle no-unthreading

DIN 5128

Icona	Gr.	Ø	L	Peso	Icona	Barcode	€
						811578 000004	
0373.030	300	50	320	426	4	8011578913274	7,65
0373.050	500	60	345	622	4	8011578938628	9,00
0373.080	800	70	350	814	2	8011578938642	12,70



373Z MAZZUOLA RAME - manico legno
 Copper mallet - wooden handle

Icona	Gr.	Peso	Icona	Barcode	€
				811578 000004	
0373.905	500	580	2	8011578965921	34,30
0373.908	800	900	2	8011578965945	54,70
0373.910	1000	1150	2	8011578965969	68,25
0373.915	1500	1600	2	8011578965983	102,30



374 MAZZUOLA ANTIRIMBALZO
 NO REBOUND Mallet

Gr.	Ø	←-L→	📦	📦	📦	€	
0374.050	500 - 1	44	300	504	4	8011578943981	11,80
0374.060	600 - 1,5	49	310	650	4	8011578944001	12,85
0374.080	900 - 2	53	340	866	2	8011578944025	15,20
0374.100	1000 - 2,5	57	380	1120	2	8011578944049	17,50

375 MAZZUOLA ANTIRIMBALZO - manico legno
 NO REBOUND Mallet - wooden handle

Ø	←-L→	📦	📦	📦	€	
0375.030	30	100 x 350	354	4	8011578963521	24,40
0375.035	35	120 x 370	534	4	8011578963545	27,55
0375.040	40	125 x 375	632	4	8011578963569	31,10
0375.050	50	145 x 380	978	2	8011578963583	44,20
0375.060	60	150 x 450	1750	2	8011578963606	54,95

376 MAZZUOLA ANTIRIMBALZO - manico acciaio
 NO REBOUND Mallet - steel handle

Ø	←-L→	📦	📦	📦	€	
0376.035	35	122 x 295	610	4	8011578963620	27,75
0376.040	40	125 x 305	710	4	8011578963644	33,30
0376.050	50	145 x 365	1120	2	8011578963668	43,30
0376.060	60	150 x 375	1732	2	8011578963682	54,40

376 RICAMBI PER MAZZUOLE per art. 375-376 - poliuretano
 SPARE FOR MALLETS for art. 375-376 - polyurethane

Ø	📦	📦	📦	€	
0376.130	30	30	6	8011578963705	4,35
0376.135	35	48	6	8011578963729	6,55
0376.140	40	70	6	8011578963743	8,10
0376.150	50	132	6	8011578963767	12,00
0376.160	60	172	6	8011578963781	16,30

alla coppia - in couple



377 **MARTELLI PER MECCANICI - acciaio al carbonio - finitura verniciata - manico legno**
HAMMER FOR MECHANIC - carbon steel - varnished finish - wooden handle

DIN 1041

Gr.	H-L	Icona	Quantità	Barcode	€
0377.010 100	260		6	8011578913366	6,15
0377.020 200	280		6	8011578913397	6,40
0377.030 300	300		6	8011578913427	7,75
0377.040 400	310		6	8011578913458	9,05
0377.050 500	320		6	8011578913489	10,00
0377.060 600	330		6	8011578913519	11,10
0377.080 800	350		4	8011578913540	12,35
0377.100 1000	350		4	8011578913571	13,80
0377.150 1500	380		2	8011578913601	17,85
0377.200 2000	400		2	8011578913663	21,05



Pro
INDUSTRIAL

378 **MANICO PER MARTELLI**
HANDLE FOR HAMMER

Gr.	H-L	Icona	Barcode	€
0378.010 100	260		8011578913694	1,90
0378.020 200	280		8011578913724	2,00
0378.030 300	300		8011578913755	2,20
0378.040 400	310		8011578913786	2,40
0378.050 500	320		8011578913816	2,60
0378.060 600	330		8011578913847	2,80
0378.080 800	350		8011578913878	3,10
0378.100 1000	360		8011578913908	3,40
0378.150 1500	375		8011578942083	3,80
0378.200 2000	400		8011578942106	4,20



380 **MARTELLI PER MECCANICI - acciaio carbonio finitura verniciata - manico sintetico antivibrazione**
HAMMER FOR MECHANIC - carbon steel varnished finish - synthetic handle no-vibration

Pro
INDUSTRIAL

GOMMOGRIP
MUNDIAL

Impugnatura morbida bicomponente.
 Soft bicomponent handle.

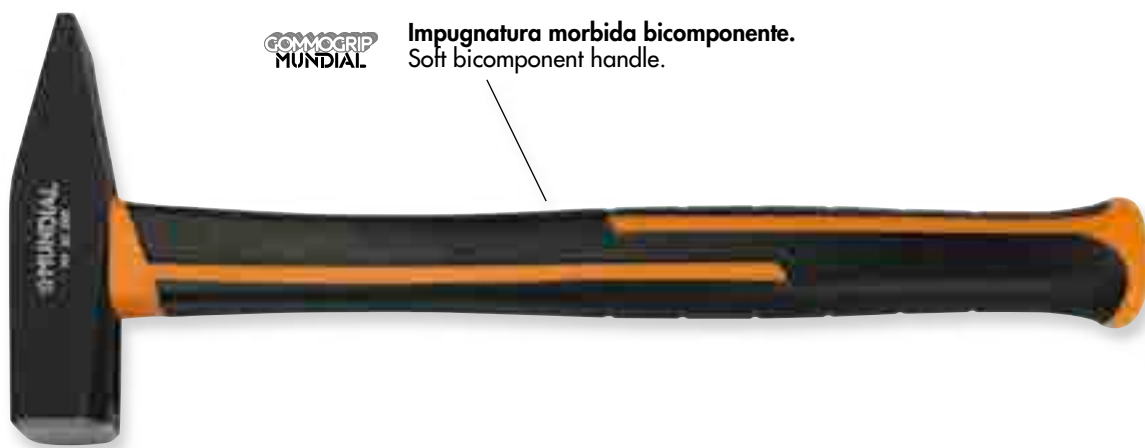

Gr.	H-L	Icona	Quantità	Barcode	€
0380.020 200	290		6	8011578913939	8,95
0380.030 300	300		6	8011578913960	11,55
0380.050 500	320		6	8011578914028	13,30
0380.080 800	320		6	8011578942649	16,90
0380.100 1000	320		6	8011578942663	18,30

381 **MARTELLI PER FALEGNAMI - manico legno**
HAMMER FOR CARPENTER - wooden handle

Gr.	H-L	Icona	Quantità	Barcode	€
0381.030 300	300		6	8011578914059	9,65



382 MARTELLI PER CARPENTIERI - manico legno
 HAMMER FOR CARPENTERS - wooden handle



Gr.	←-L-→	👤	📦	8 011578 000004	€
0382.030 300	440	530	6	8011578914110	11,25
0382.040 400	440	585	6	8011578914141	12,35

382B MANICO
 HANDLE



Gr.	←-L-→	👤	8 011578 000004	€
0382.210 300/400	440	175	8011578914233	2,65

382Z MARTELLI CARPENTIERI MANICO FIBRA CON CALAMITA
 SYNTHETIC HANDLE HAMMER WITH MAGNET



Gr.	←-L-→	👤	📦	8 011578 000004	€
0382.925 250	500	653	4	8011578934248	16,70
0382.930 300	500	683	4	8011578934262	17,55
0382.940 400	500	766	4	8011578934286	18,90

383 MAZZETTA PER MURATORE - manico legno
 HAMMER FOR MASON - wooden handle



Gr.	←-L-→	👤	📦	8 011578 000004	€
0383.080 800	260	954	2	8011578914264	10,25
0383.100 1000	260	1128	2	8011578914271	11,10
0383.120 1200	260	1320	2	8011578973100	13,65
0383.150 1500	260	1500	2	8011578982966	15,65 new
0383.200 2000	260	2150	2	8011578973124	17,75

383Z MAZZETTA MURATORE MANICO FIBRA
 MALLET FOR MASON SYNTHETIC HANDLE

Pro
 INDUSTRIAL



Gr.	←-L-→	👤	📦	8 011578 000004	€
0383.908 800	265	1034	2	8011578934309	13,80
0383.910 1000	280	1198	2	8011578934323	15,45
0383.912 1250	280	1420	2	8011578934347	15,55



384 MARTELLLO MURATORE - manico legno
 HAMMER FOR MASON - wooden handle







	Gr.				€
0384.040	400	500	2	8011578970383	12,95

385 MARTELLINA MALAPEGGIO - manico legno
 HAMMER FOR MASON - wooden handle



	Gr.				€
0385.040	400	500	2	8011578966027	16,60

385B MARTELLLO CALDERAIO - manico legno
 BALL PEIN HAMMER - wooden handle

	Gr.				€
0385.903	300	380	2	8011578966041	11,65
0385.905	500	588	2	8011578966065	13,50
0385.908	800	990	2	8011578966089	17,75
0385.910	1000	1100	2	8011578966102	20,50



386 MARTELLLO PER OROLOGIAIO - finitura cromata - manico legno
 HAMMER FOR WATCHMAKERS - chrome plated fin. - wooden handle



	Gr.				€
0386.010	35	230	52	6 8011578914295	12,20



390 ESPOSITORE 18 MARTELLI
 DISPLAY STAND 18 HAMMERS

Contenuto-content:

0380.020	200	Nr. 2	0382.930	300	Nr. 2
0380.030	300	Nr. 2	0383.908	800	Nr. 2
0380.050	500	Nr. 2	0383.910	1000	Nr. 2
0380.080	800	Nr. 1	0383.912	1250	Nr. 2
0380.100	1000	Nr. 1			
0382.925	250	Nr. 2			

			€
0390.010	500 x 500 x 400	19100	8011578947446 260,90
0390.210	vuoto - empty	3300	8011578948740 42,40



402 TAGLIABULLONI - acciaio speciale alta resistenza al taglio - finitura verniciata - impugnatura isolata

BOLT CUTTERS - special steel high cut resistant - varnished finish - insulated handle



Icona	L	W	H	W	W	Icona	Icona	Icona	€
0402.035	350	5	60 x 7	897	1	8011578	000004	8011578960582	25,50
0402.045	450	6	69 x 8	1560	1	8011578	000004	8011578960605	33,20
0402.060	600	8	84 x 9,6	2650	1	8011578	000004	8011578960629	46,75
0402.075	750	10	96 x 11	3900	1	8011578	000004	8011578960643	65,20
0402.090	900	12	108 x 13	5650	1	8011578	000004	8011578960667	89,80

403 LAME RICAMBIO TAGLIABULLONI - acciaio speciale alta resistenza al taglio

SPARE HEADS FOR BOLT CUTTERS - special steel-high cut resistant

Icona	L	W	H	W	W	Icona	Icona	Icona	€
0403.035	350	5	60 x 7	344	1	8011578	000004	8011578914622	14,30
0403.045	450	6	69 x 8	530	1	8011578	000004	8011578914653	19,80
0403.060	600	8	84 x 9,6	910	1	8011578	000004	8011578914684	24,25
0403.075	750	10	96 x 11	1310	1	8011578	000004	8011578914714	33,90
0403.090	900	12	108 x 13	1960	1	8011578	000004	8011578914745	45,05



404 MINI TAGLIABULLONI - acciaio speciale alta resistenza al taglio - finitura verniciata - impugnatura plasticata

BOLT CUTTERS-SMALL - special steel high cut resistant - varnished finish - plastic handle



Icona	L	W	H	W	W	Icona	Icona	Icona	€
0404.020	200	4	38 x 4,5	304	6	8011578	000004	8011578914776	15,05

404.900 ESPOSITORE IN CARTONE 18 MINI TAGLIABULLONI

CARTON DESK DISPLAY 18 MINI BOLT CUTTERS



Contenuto-content:
0404.020 Nr. 18

Icona	L	W	H	W	W	Icona	Icona	Icona	€
0404.900	260 x 260 x 260			6300	1	8011578	000004	8011578947460	270,90

405 TRONCHESE TAGLIAFUNI PER FUNI ACCIAIO

WIRE ROPE CUTTER



Icona	L	W	H	W	W	Icona	Icona	Icona	€
0405.030	600	16		2500	1	8011578	000004	8011578960681	71,00
0405.035	900	20		5600	1	8011578	000004	8011578960704	86,90

407 TRONCHESE TAGLIACAVI PER FUNI ACCIAIO

WIRE ROPE CUTTER



Icona	L	W	H	W	W	Icona	Icona	Icona	€
0407.010	190	6		338	6	8011578	000004	8011578943868	25,30

408 TRONCHESE TAGLIANTE FRONTALE - acciaio chrom-vanadium finitura cromata - impugnatura isolata
 END CUTTING NIPPERS - chrom-vanadium steel chrome plated finish- insulated handle



DIN 5748

      €
0408.016 160 22 240 6 8011578914837 **11,75**

409 TRONCHESE TAGLIO DIAGONALE GRANDE EFFETTO - acciaio chrom-vanadium finitura cromata - impugnatura isolata
 HEAVY DUTY DIAGONAL CUTTING NIPPERS - chrom-vanadium steel chrome plated finish - insulated handle



DIN ISO 5749

      €
0409.018 180 20 272 6 8011578914868 **12,30**

410 TRONCHESE TAGLIO DIAGONALE A LEVA GRANDE EFFETTO - INDUSTRIA - acciaio chrom-vanadium EXTRA fin. lucida
 HIGH LEVERAGE CUTTER WITH DIAGONAL CUTTING - INDUSTRIAL- chrom-vanadium EXTRA steel polish finish

Pro
 INDUSTRIAL

Impugnatura isolata morbida bicomponente
 Insulated bicomponent soft handle

Capacità taglio ø 4 mm ferro - ø 1,6 acciaio armonico
 Cut capacity ø 4 mm iron - ø 1,6 piano steel
 Tagliante - Cut 58-63° HRC
 Pinza - Plier 43-48° HRC

DIN ISO 5749

      €
0410.016 160 22 222 6 8011578967000 **14,20**

distanza ridotta della cerniere - riduce lo sforzo del 45%
 reduced distance of join - less effort of 45%



412Z TRONCHESE TAGLIO DIAGONALE - acciaio chrom-vanadium finitura cromata
 CUTTER WITH DIAGONAL CUTTING - chrom-vanadium steel chrome plated finish

COMMOGRIP  **MUNDIAL** Impugnatura isolata morbida bicomponente in gomma-pvc
 Insulated bicomponent soft handle in rubber-pvc

Quality
 GUARANTEED
 DURABLE



DIN ISO 5749

      €
0412.916 160 20 230 6 8011578915018 **11,10**

414 TRONCHESE TAGLIO INCLINATO - acciaio chrom-vanadium finitura lucida - impugnatura plasticata
 CUTTER WITH OBLIQUE CUTTING - chrom-vanadium polished finish steel - plastic handle









      €

0414.015 150 20 150 6 8011578915049 23,55

415 TRONCHESE TAGLIO INCLINATO PER MATERIALE PLASTICO - FILO RASO - acciaio chrom-vanadium finitura lucida
 DIAGONAL CUTTER FOR PLASTIC- FLUSH CUTTING EDGE- chrom-vanadium polished finish steel



      €

0415.016 160 142 6 8011578942069 19,65
 0415.017 170 224 6 8011578976941 25,45 new

416 TRONCHESE TAGLIO OBLIQUO 45° PER MATERIALE PLASTICO - FILO RASO - acciaio chrom-vanadium finitura lucida
 CUTTER WITH OBLIQUE 45° CUTTING FOR PLASTIC- FLUSH CUTTING EDGE - chrom-vanadium polished finish steel



      €

0416.010 150 20 132 6 8011578967024 30,75



417 TENAGLIE PER CEMENTISTI - acciaio finitura verniciata - impugnatura plasticata
 TOWER PINCERS - steel varnished finish - plastic handle



DIN ISO 9242

Model	Size	Tip	Weight	Qty	Barcode	Price
0417.020	200	22	206	6	8011578915070	6,95
0417.022	220	23	308	6	8011578915100	7,60
0417.025	250	25	410	6	8011578915131	8,25
0417.028	280	25	417	6	8011578970789	9,90



417.900 ESPOSITORE IN CARTONE 18 TENAGLIE
 CARTON DESK DISPLAY 18 PINCERS

Contenuto-content:

0417.022 Nr. 12

0417.025 Nr. 6

Model	Size	Weight	Barcode	Price
0417.900	260 x 260 x 260	7000	8011578947507	140,70



418 TENAGLIE PER CEMENTISTI EXTRA - acciaio chrom-vanadium
 TOWER PINCERS EXTRA - chrom-vanadium steel



DIN ISO 9242

Model	Size	Tip	Weight	Qty	Barcode	Price
0418.022	220	23	316	6	8011578915162	10,80
0418.025	250	25	382	6	8011578915193	12,30
0418.028	280	25	462	6	8011578947521	13,90



420 TENAGLIE PER CEMENTISTI EXTRA - acciaio chrom-vanadium - impugnatura plasticata
 TOWER PINCERS EXTRA - chrom-vanadium steel - plastic handle



DIN ISO 9242

Model	Size	Tip	Weight	Qty	Barcode	Price
0420.022	220	23	340	6	8011578915223	11,65
0420.025	250	25	394	6	8011578915254	12,90
0420.028	280	25	472	6	8011578942946	14,50



420.900 ESPOSITORE IN CARTONE 18 TENAGLIE
 CARTON DESK DISPLAY 18 PINCERS

Contenuto-content:

0420.022 Nr. 12

0420.025 Nr. 6

Model	Size	Weight	Barcode	Price
0420.900	260 x 260 x 260	7114	8011578947545	217,20









423 TENAGLIE PICCOLE - acciaio chrom-vanadium finitura fosfatata - impugnatura plasticata
 END CUTTING SMALL PINCERS - chrom-vanadium steel phosphated finish - plastic handle

						
0423.018	180	25	248	6	8011578915285	11,70

425 TENAGLIE PER FALEGNAMI - acciaio - impugnatura plasticata
 PINCERS FOR CARPENTERS - steel - plastic handle

DIN ISO 9243

						
0425.018	180	23	282	6	8011578915315	9,35
0425.020	200	25	398	6	8011578915346	10,50

430 PINZA CALZOLAI CON MARTELLO
 SHOEMAKERS PLIERS WITH HAMMER

					
0430.010	200	356	6	8011578934385	20,00

431 PINZA CALZOLAI RETTA
 SHOEMAKERS PLIERS - STRAIGHT

					
0431.010	200	396	6	8011578934408	18,50

432 PINZA CALZOLAI CURVA
 SHOEMAKERS PLIERS - BENT

					
0432.010	200	403	6	8011578934422	18,70



433 PINZA PER RETI AUTOMATICA CON CARICATORE - tipo professionale - posatori
 FENCE PLIERS AUTOMATIC WITH LOADER - professional type - installer



Model	Size	foro-hole	Quantity	Unit	Barcode	Price
0433.016	16-18	foro-hole Ø 3÷8	296	1	8011578972042	38,30
0433.020	20	foro-hole Ø 5÷11	300	1	8011578972066	38,30

433. PINZA PER RETI AUTOMATICA CON CARICATORE + PUNTI - tipo professionale - posatori
 FENCE PLIERS AUTOMATIC WITH LOADER + STAPLES - professional type - installer

Model	Size	Staples	Quantity	Unit	Barcode	Price
con punti ZINCATI / with ZINC staples:						
0433.816	16-18	1000 punti / staples	910	1	8011578972165	49,90
0433.820	20	960 punti / staples	1050	1	8011578972189	51,05
con punti VERDI / with GREEN staples:						
0433.916	16-18	1000 punti / staples	910	1	8011578972202	61,60
0433.920	20	960 punti / staples	1050	1	8011578972226	65,00



433.1 PUNTI ZINCATI in stecca - tipo professionale
 STAPLES ZINC - professional type



Model	Size	foro-hole	Quantity	Unit	Barcode	Price
0433.116	16-18	foro-hole Ø 3÷8	610	1000	8011578972080	11,60
0433.120	20	foro-hole Ø 5÷11	740	960	8011578972103	12,75

433.2 PUNTI VERDI in stecca
 STAPLES GREEN - professional type



Model	Size	foro-hole	Quantity	Unit	Barcode	Price
0433.216	16-18	foro-hole Ø 3÷8	610	1000	8011578972127	23,30
0433.220	20	foro-hole Ø 5÷11	740	960	8011578972141	26,70

434 PINZA PER RETI AUTOMATICA CON CARICATORE - tipo standard
 FENCE PLIERS AUTOMATIC WITH LOADER - standard type



Model	Size	foro-hole	Quantity	Unit	Barcode	Price
0434.016	16	foro-hole Ø 3÷8	290	1	8011578972240	27,85
0434.020	20	foro-hole Ø 5÷11	300	1	8011578972264	27,85

434. PINZA PER RETI AUTOMATICA CON CARICATORE + PUNTI - tipo standard
 FENCE PLIERS AUTOMATIC WITH LOADER + STAPLES - standard type

Model	Size	Staples	Quantity	Unit	Barcode	Price
con punti ZINCATI / with ZINC staples:						
0434.816	16	1000 punti/staples	590	1	8011578972363	39,45
0434.820	20	1000 punti/staples	1080	1	8011578972387	40,60
con punti VERDI / with GREEN staples:						
0434.916	16	1000 punti/staples	590	1	8011578972400	51,15
0434.920	20	1000 punti/staples	1080	1	8011578972424	54,55



434.1 PUNTI ZINCATI in stecca - tipo standard
 STAPLES ZINC - standard type



Model	Size	foro-hole	Quantity	Unit	Barcode	Price
0434.116	16	foro-hole Ø 3÷8	300	1000	8011578972288	11,60
0434.120	20	foro-hole Ø 5÷11	780	1000	8011578972301	12,75

434.2 PUNTI VERDI in stecca - tipo standard
 STAPLES GREEN - standard type



Model	Size	foro-hole	Quantity	Unit	Barcode	Price
0434.216	16	foro-hole Ø 3÷8	300	1000	8011578972325	23,30
0434.220	20	foro-hole Ø 5÷11	780	1000	8011578972349	26,70

435 PINZA CHIUSURA GANCI RETI TIPO PICCOLO - finitura verniciata - impugnatura plasticata

PLIER FOR CLOSING HOOKS FOR NETS - SMALL - varnished finish - plastic handle







0435.010 foro-hole Ø 6,3
  210
  250
  6
  80115781000004
 € **17,05**

435. PINZA CHIUSURA GANCI RETI TIPO PICCOLO + 1 KG. GANCI

PLIER FOR CLOSING HOOKS FOR NETS - SMALL + 1 KG. HOOKS













0435.015 foro-hole Ø 6,3
  210
  1260
  1
  80115781000004
 € **31,25**

435... GANCI PER RETI - piccoli - finitura zincata

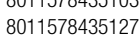
HOOKS FOR NETS - small - zinc finish

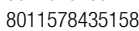







mm. 5 x 15 spessore - thickness 0,90 - 2÷4 Ø

0435.110 ART. 435/A 1300
  Kg. 1
  1
  8011578435103
 € **13,50**
0435.210 ART. 435/B
  Kg. 5
  1
  8011578435127
 € **62,25**
0435.310 ART. 435/C
  Kg. 25
  1
  8011578435158
 € **292,50**

435X GANCI PER RETI - piccoli - acciaio INOX

HOOKS FOR NETS - small - STAINLESS steel

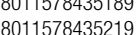
mm. 5 x 15 spessore - thickness 0,80 - 2÷4 Ø

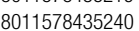
0435.901 1450
  Kg. 1
  1
  8011578435189
 € **25,00**
0435.905
  Kg. 5
  1
  8011578435219
 € **120,00**
0435.925
  Kg. 25
  1
  8011578435240
 € **575,00**

436. PINZA CHIUSURA GANCI RETI TIPO GRANDE - finitura verniciata - impugnatura plasticata

PLIERS FOR CLOSING HOOKS FOR NETS - BIG - varnished finish - plastic handle



0436.010 foro-hole Ø 9,3
  210
  253
  6
  8011578915612
 € **19,60**

436 PINZA CHIUSURA GANCI RETI TIPO GRANDE + 1 KG. GANCI

PLIERS FOR CLOSING HOOKS FOR NETS - BIG + 1 KG. HOOKS













0436.015 foro-hole Ø 9,3
  210
  1263
  1
  8011578968021
 € **33,80**

436... GANCI PER RETI - grandi - finitura zincata

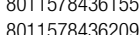
HOOKS FOR NETS - big - zinc finish

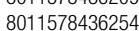







mm. 7 x 22 spessore - thickness 1,00 - 4÷8 Ø

0436.110 ART. 436/A 600
  Kg. 1
  1
  8011578436155
 € **13,50**
0436.210 ART. 436/B
  Kg. 5
  1
  8011578436209
 € **62,25**
0436.310 ART. 436/C
  Kg. 25
  1
  8011578436254
 € **292,50**

436X GANCI PER RETI - grandi - acciaio INOX

HOOKS FOR NETS - big - STAINLESS steel

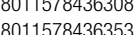
mm. 7 x 22 spessore - thickness 0,80- 4÷8 Ø

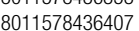
0436.901 750
  Kg. 1
  1
  8011578436308
 € **25,00**
0436.905
  Kg. 5
  1
  8011578436353
 € **120,00**
0436.925
  Kg. 25
  1
  8011578436407
 € **575,00**

437 PINZA CHIUSURA GANCI GABBIONI E PALI - finitura verniciata - impugnatura plasticata
 PLIER FOR CLOSING HOOKS FOR GABIONS AND POST - varnished finish - plastic handle



0437.010 270 462 2 8011578968045 € 22,30

437A GANCI PER GABBIONI E PALI - finitura zincata
 HOOKS FOR GABIONS AND POST - zinc finish



0437.110 Kg. 1 1 8011578968069 € 18,85

439D ESPOSITORE 36 PINZE E PINZE PER ANELLI
 DISPLAY STAND 36 PLIERS AND LOCK RINGS PLIERS

Contenuto-content:

0490.024 Nr. 6 0506.017 Nr. 6
 0420.022 Nr. 6 0510.018 Nr. 6
 0505.018 Nr. 6 0511.017 Nr. 6



0439.410 490 x 215 x 180 15600 8011578985523 € 459,60

439E ESPOSITORE 36 PINZE REGOLABILI
 DISPLAY STAND 36 WATERPUMP PLIERS

Contenuto-content:

0490.018 Nr. 6 0491.030 Nr. 6
 0490.024 Nr. 6 0490.030 Nr. 6
 0491.024 Nr. 6 0492.024 Nr. 6



0439.510 490 x 215 x 180 15600 8011578985547 € 740,40

439C ESPOSITORE 36 PINZE E TENAGLIE
 DISPLAY STAND 36 PLIERS AND PINCERS

Contenuto-content:

0490.018 Nr. 6 0420.025 Nr. 6
 0490.024 Nr. 6 0404.020 Nr. 6
 0420.022 Nr. 6 0425.020 Nr. 6



0439.310 490 x 215 x 180 15600 8011578439033 € 488,70

439.900
ESPOSITORE IN CARTONE 18 PINZE E TRONCHESI
CARTON DESK DISPLAY 18 PLIERS AND CUTTERS

Contenuto-content:

 0440.918 Nr. 12
 0412.916 Nr. 3
 0463.916 Nr. 3

 0439.900 260 x 260 x 260

 5000

 8011578947569

 € 207,15
**439.911**
ESPOSITORE IN CARTONE 18 PINZE UNIVERSALI E TRONCHESI
CARTON DESK DISPLAY 18 PLIERS AND CUTTERS

 - LEVA GRANDE EFFETTO INDUSTRIA
 - HIGH LEVERAGE INDUSTRIAL

Contenuto-content:

 0441.018 Nr. 12
 0410.016 Nr. 3
 0462.016 Nr. 3

 0439.911 260 x 260 x 260



 5000

 8011578968083



 € 287,40
**439.912**
ESPOSITORE IN CARTONE 18 PINZE UNIVERSALI
CARTON DESK DISPLAY 18 PLIERS

Contenuto-content:

 0456.016 Nr. 3
 0456.018 Nr. 12
 0456.020 Nr. 3

 0439.912 260 x 260 x 260

 4300

 8011578947583



 € 185,25
**439ZF**
ESPOSITORE 36 PINZE E TRONCHESI - finitura cromata - metallo
DISPLAY STAND 36 PLIERS AND CUTTERS - chrome plated finish - metal
COMMOGRIP Impugnatura isolata morbida bicomponente in gomma-pvc
MUNDIAL Insulated bicomponent soft handle in rubber-pvc

Contenuto-content:

 0412.916 160 Nr. 6
 0440.916 160 Nr. 6
 0440.918 180 Nr. 6
 0463.916 160 Nr. 6
 0466.916 160 Nr. 6
 0467.916 160 Nr. 6

 0439.915 490 x 215 x 180
 0439.220 vuoto - empty

 11600
 4150

 8011578439200
 8011578916008

 € 401,40
 45,00

440Z

PINZA UNIVERSALE - acciaio chrom-vanadium finitura cromata
 COMBINATION PLIERS - chrom-vanadium steel chrome plated finish



Impugnatura isolata morbida bicomponente in gomma-pvc
 Insulated bicomponent soft handle in rubber-pvc



DIN ISO 5746

Model	Length	Tip Width	Tip Height	Weight	Material	Barcode	Price (€)
0440.916	160	5,5 x 9,5	33,5	210	6	8011578916152	10,70
0440.918	180	5,8 x 10,0	36,5	264	6	8011578916183	11,75
0440.920	200	7,0 x 10,5	39,5	318	6	8011578916213	13,00

441

PINZA UNIVERSALE A LEVA GRANDE EFFETTO - INDUSTRIA - acciaio chrom-vanadium EXTRA finitura lucida
 HIGH LEVERAGE COMBINATION PLIERS - INDUSTRIAL - chrom-vanadium EXTRA steel polish finish

Impugnatura isolata morbida bicomponente
 Insulated bicomponent soft handle

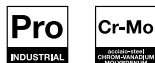

distanza ridotta della cerniere - riduce lo sforzo del 45%
 reduced distance of join - less effort of 45%



Tagliente - Cut 58-63° HRC
 Pinza - Plier 43-48° HRC

DIN ISO 5746

Model	Length	Tip Width	Tip Height	Weight	Material	Barcode	Price (€)
0441.018	180	5,8 x 10,0	41,0	285	6	8011578967048	16,60
0441.020	200	7,0 x 10,5	42,0	320	6	8011578970963	17,45

456

PINZA UNIVERSALE - acciaio chrom-vanadium finitura cromata - impugnatura plasticata
 COMBINATION PLIERS - chrom-vanadium steel chrome plated finish - plastic handle



DIN ISO 574

Model	Length	Tip Width	Tip Height	Weight	Material	Barcode	Price (€)
0456.016	160	5,5 x 9,5	33,5	162	6	8011578916336	9,70
0456.018	180	5,8 x 10,0	36,5	218	6	8011578916367	10,00
0456.020	200	7,0 x 10,5	39,5	274	6	8011578916398	12,05

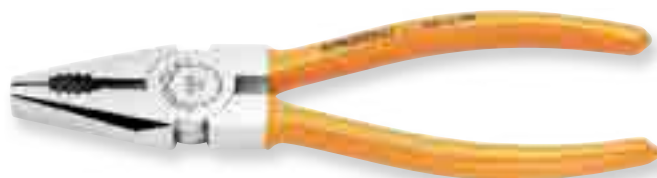

462

PINZA BECCHI MEZZ.I CON TAGLIANTE A LEVA GRANDE EFFETTO - INDUSTRIA - acciaio chrom-vanadium EXTRA fin. lucida
 HIGH LEVERAGE HALF NOSE PLIERS WITH CUTTER - INDUSTRIAL - chrom-vanadium EXTRA steel polish finish

Impugnatura isolata morbida bicomponente
 Insulated bicomponent soft handle



distanza ridotta della cerniere - riduce lo sforzo del 45%
 reduced distance of join - less effort of 45%

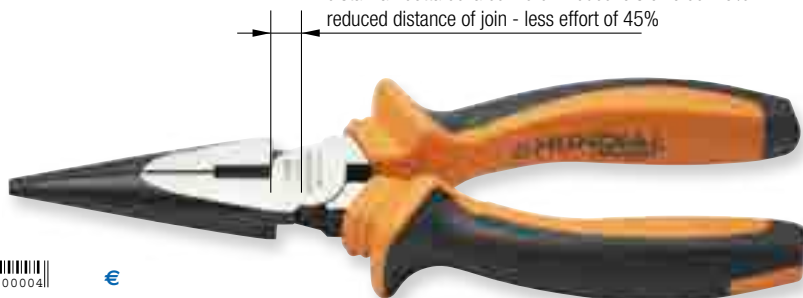







Tagliente - Cut 58-63° HRC
 Pinza - Plier 43-48° HRC

Model	Length	Tip Width	Tip Height	Weight	Material	Barcode	Price (€)
0462.016	160	3 x 2,5	53	174	6	8011578968106	15,20
0462.020	200	3 x 2,5	77	210	6	8011578970987	16,15

463Z PINZA BECCHI MEZZOTONDI CON TAGLIENTE - cromata
 HALF NOSE PLIERS WITH CUTTER - chrome









							€
0463.916	170	3 x 2,5	61	154	6	8011578916725	10,95
0463.920	200	3 x 2,5	77	213	6	8011578916756	12,20

466Z PINZA BECCHI MEZZOTONDI PIEGATI CON TAGLIENTE E GIRATUBO - acciaio chrom-vanadium finitura cromata
 BENT LONG HALF NOSE PLIERS WITH CUTTER AND PIPE GRIP - chrom-vanadium steel chrome plated finish









DIN ISO 5745

							€
0466.916	170	3 x 2,5	61	162	6	8011578916909	11,60
0466.920	200	3 x 2,5	77	208	6	8011578916930	12,60

467Z PINZA BECCHI PIATTI RETTI - acciaio chrom-vanadium finitura cromata
 FLAT STRAIGHT NOSE PLIERS - chrom-vanadium steel chrome plated finish



DIN ISO 5745

							€
0467.916	160	3 x 5	49	172	6	8011578917050	10,80

469Z PINZA BECCHI TONDI RETTI - acciaio chrom-vanadium finitura cromata
 ROUND STRAIGHT NOSE PLIERS - chrom-vanadium steel chrome plated finish



DIN ISO 5745

							€
0469.916	160	2,5	49	142	6	8011578917142	12,30



472 PINZA COMBINATA PER GOMMISTI - acciaio chrom-vanadium finitura cromata - impugnatura plasticata
 WHEEL BALANCE WEIGHT PLIERS - chrom vanadium steel chrome plated finish - plastic handle



0472.010 240 366 6 8011578917203 € 18,00

474 PINZA AUTOBLOCCANTE GANASCE CONCAVE - acciaio chrom-vanadium finitura nichelata
 LOCK-GRIP PLIERS CONCAVE JAWS - chrom-vanadium steel nickel plated finish

Pro INDUSTRIAL



0474.014 140 182 2 8011578963385 € 11,20
 0474.018 180 370 2 8011578917234 € 16,15
 0474.025 250 610 2 8011578917265 € 20,70

475 PINZA AUTOBLOCCANTE GANASCE CONCAVE - 4 CREMAGLIERE - acciaio chrom-vanadium finitura nichelata
 LOCK-GRIP PLIERS CONCAVE JAWS - 4 RACK - chrom-vanadium steel nickel plated finish

Pro INDUSTRIAL



0475.025 250 610 2 8011578976927 € 33,15 new

476 PINZA AUTOBLOCCANTE PER SALDATORI - acciaio chrom-vanadium finitura nichelata
 LOCK-GRIP PLIERS FOR WELDER - chrom-vanadium steel nickel plated finish



0476.010 270 804 2 8011578917326 € 28,20

478 PINZA AUTOBLOCCANTE A MORSETTO - acciaio chrom-vanadium finitura nichelata
 CLAMP LOCK-GRIP PLIERS - chrom-vanadium steel nickel plated finish



 **0478.010**  280   802  80115781000004  **26,25**











478Z PINZA AUTOBLOCCANTE A MORSETTO CON BASCULANTI - acciaio chrom-vanadium finitura nichelata
 CLAMP LOCK-GRIP PLIER WITH SWIVEL PAD - chrom-vanadium steel nickel plated finish



 **0478.910**  280   985  80115781000004  **29,10**

479 PINZA AUTOBLOCCANTE - ganasce lunghe
 LOCK-GRIP PLIERS - long jaws

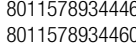

 **0479.016**  160   174  80115781000004  **11,70**
0479.020  220   180  80115781000004  **13,00**



480 PINZA AUTOBLOCCANTE A MORSETTO - lunghe
 CLAMP LOCK-GRIP PLIERS - long



0480.010 460 1380 1 8011578973148 € 33,70

482 PINZA AUTOBLOCCANTE GANASCE PIATTE
 CLAMP LOCK-GRIP PLIERS SHEET CLAMP



0482.010 200 522 2 8011578973162 € 14,30

483 PINZA AUTOBLOCCANTE A CATENA APERTURA DIAMETRO mm 150
 CLAMP LOCK-GRIP PLIERS CHAIN CLAMP mm 150





0483.010 250 768 2 8011578973186 € 25,05

490
PINZA REGOLABILE CERNIERA CHIUSA - acciaio chrom-vanadium-molibdeno finitura verniciata - impugnatura plasticata
WATERPUMP JOINT BOX PLIERS - chrom-vanadium-molybdenum steel varnished finish - plastic handle
Pro
 INDUSTRIAL

Cr-Mo
 acciaio cromovanadio molibdeno

DIN ISO 8976

Icona	↔ L ↔	Icona	Icona	8 011578 000004	€
	180		175		14,65
0490.018	180	6	8011578938680		
0490.024	240	6	8011578917388		16,70
0490.030	300	6	8011578917418		22,05

490.900
ESPOSITORE IN CARTONE 18 PINZE
CARTON DESK DISPLAY 18 PLIERS

Contenuto-content:

0490.018 Nr. 3

0490.024 Nr. 12



0490.030 Nr. 3

Icona	↔ L ↔	Icona	Icona	8 011578 000004	€
	260 x 260 x 260		6200		310,50
0490.900	260 x 260 x 260			8011578947606	

491
PINZA REGOLABILE CERNIERA CHIUSA A PULSANTE - acciaio chrom-vanadium finitura verniciata - imp. plasticata
WATERPUMP BOX JOINT PLIER WITH PUSH BUTTON - chrom-vanadium steel varnished finish - plastic handle
Pro
 INDUSTRIAL

 pulsante
 push button

DIN ISO 8976

Icona	↔ L ↔	Icona	Icona	8 011578 000004	€
	240		330		19,25
0491.024	240	6	8011578963408		
0491.030	300	6	8011578965907		23,10

491.900
ESPOSITORE IN CARTONE 18 PINZE A PULSANTE
CARTON DESK DISPLAY 18 PLIERS WITH PUSH BUTTON

Contenuto-content:

0491.024 Nr. 18

Icona	↔ L ↔	Icona	Icona	8 011578 000004	€
	260 x 260 x 260		6000		346,50
0491.900	260 x 260 x 260			8011578963422	

492 PINZA REGOLABILE - Regolazione Automatica
 WATERPUMP PLIERS - Automatic

si adatta automaticamente alle dimensioni da serrare con una sola mano
 automatic adjustment to the dimensions to close with one hand

Pro
 INDUSTRIAL

Model	Length (mm)	Weight (g)	Material	Quantity	Barcode	Price (€)
0492.018	180	168	6	8011578943783	22,15	
0492.024	240	355	6	8011578943806	27,65	
0492.030	300	560	6	8011578943820	33,40	



regolazione automatica
 automatic

492.900 ESPOSITORE 18 PINZE AUTOMANICHE
 DISPLAY 18 AUTOMATIC PLIERS

Contenuto-content:

- 0492.018 Nr. 3
- 0492.024 Nr. 12
- 0492.030 Nr. 3

Model	Dimensions (mm)	Weight (g)	Barcode	Price (€)
0492.900	260 x 260 x 260	7200	8011578947620	498,45



495 PINZA REGOLABILE A CREMAGLIERA - acciaio chrom-vanadium finitura cromata - impugnatura plasticata
 DOUBLE GROOVE JOINT PLIERS - chrom-vanadium steel chrome plated finish - plastic handle

DIN ISO 8976

Model	Length (mm)	Weight (g)	Material	Quantity	Barcode	Price (€)
0495.024	240	380	6	8011578917449	14,45	



497 PINZA REGOLABILE CERNIERA CHIUSA tipo STANDARD - acciaio chrom-vanadium fin. verniciata - imp. plasticata
 WATERPUMP JOINT BOX PLIERS - STANDARD type - chrom-vanadium steel varnished finish - plastic handle

Quality
 ASSICURATA

DIN ISO 8976

Model	Length (mm)	Weight (g)	Material	Quantity	Barcode	Price (€)
0497.024	240	300	6	8011578976903	9,75 new	



500 GIRATUBO TIPO LEGGERO
 PIPE WRENCH



Model	Ø	Length (mm)	Weight (g)	Material	Quantity	Barcode	Price (€)
0500.017	1"	175	326	2	8011578934606	18,20	
0500.022	1-1/2"	225	560	2	8011578934620	23,45	
0500.027	2"	275	780	2	8011578934644	27,65	
0500.030	2-1/2"	300	1020	2	8011578934668	31,55	
0500.035	3"	350	1060	2	8011578960964	33,70	

501 PINZA PER DADI RUBINETTI - fin. luc. - imp. plast.
 NUT PLIERS - polished finish - plastic handle



Model	Length (mm)	Weight (g)	Material	Quantity	Barcode	Price (€)
0501.010	250	474	6	8011578917470	25,00	

502 GIRATUBO SVEDESE 45° - acciaio chrom-vanadium finitura verniciata
 PIPE WRENCH-SWEDISH 45° - chrom-vanadium steel varnished finish

DIN 5234 B

Icona	Ø	l-l1	Icona	Icona	Barcode	€
	1/2"	250			8011578917500	23,75
	1"	320			8011578917531	27,70
	1-1/2"	400			8011578917562	40,05
	2"	530			8011578917593	64,50
	3"	650			8011578934484	121,35

502S GIRATUBO SVEDESE 45° - ganasce S
 PIPE WRENCH-SWEDISH 45° - S jaws

Icona	Ø	l-l1	Icona	Icona	Barcode	€
	1/2"	250			8011578934507	23,90
	1"	320			8011578934521	27,70
	1-1/2"	400			8011578934545	40,05
	2"	530			8011578934569	64,50
	3"	650			8011578934583	121,35

503 GIRATUBO SVEDESE 90° - acciaio chrom-vanadium finitura verniciata
 PIPE WRENCH-SWEDISH 90° - chrom-vanadium steel varnished finish

DIN 5234A

Icona	Ø	l-l1	Icona	Icona	Barcode	€
	1"	320			8011578917623	26,85
	1-1/2"	425			8011578917654	38,80
	2"	560			8011578917685	64,00
	3"	620			8011578947644	119,25

504 GIRATUBO AMERICANO - acciaio chrom-vanadium finitura verniciata
 PIPE WRENCH-AMERICAN - chrom-vanadium steel varnished finish

Icona	Ø	l-l1	Icona	Icona	Barcode	€
	1"	8"- 200			8011578917715	12,95
	1-1/2"	10"- 250			8011578917746	16,80
	2"	12"- 300			8011578917777	18,25
	2"	14"- 350			8011578917807	22,55
	2-1/2"	18"- 450			8011578917838	29,75
	3"	24"- 600			8011578917869	40,50
	4"	36"- 900			8011578960445	91,95

504A GIRATUBO AMERICANO - alluminio
 PIPE WRENCH-AMERICAN - aluminium

📄	Ø	↔	📦	📦	📄	€
0504.114	2"	14" - 350	848	1	8011578974886	30,75
0504.118	2-1/2"	18" - 450	1400	1	8011578934682	47,00
0504.124	3"	24" - 600	2400	1	8011578934705	74,40
0504.136	4"	36" - 900	4000	1	8011578934729	137,50



504S GIRATUBO STILSON - acciaio
 PIPE WRENCH STILSON - steel

📄	Ø	↔	📦	📦	📄	€
0504.725	1-1/2"	10" - 250	485	2	8011578967109	15,00
0504.735	2"	14" - 350	974	2	8011578967123	20,90
0504.745	2-1/2"	18" - 450	1507	1	8011578967147	28,50
0504.760	3"	24" - 600	2564	1	8011578967161	47,00
0504.790	4"	36" - 900	4674	1	8011578967185	88,70



504ZF GIRATUBO A CATENA REVERSIBILE
 PIPE WRENCH-CHAIN REVERSIBLE

📄	Ø	↔	📦	📦	📄	€
0504.950	4"	300	783	1	8011578944209	36,05
catena di ricambio - spare chain:						
0504.953	4"	420	264	1	8011578970727	16,95



504ZT GIRATUBO A CATENA REVERSIBILE
 PIPE WRENCH-CHAIN REVERSIBLE

📄	Ø	↔	📦	📦	📄	€
0504.960	6"	900	9400	1	8011578967208	141,60
catena di ricambio - spare chain:						
0504.963	6"	820	300	1	8011578976323	33,90







504ZZ GIRATUBO A NASTRO
 BELT WRENCH

📄	Ø	📦	📦	📄	€
0504.990	90	414	1	8011578968120	26,20







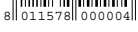

505 PINZA PER ANELLI ELASTICI ESTERNI BECCHI DIRITTI - acciaio chrom-vanadium - impugnatura plasticata
 EXTERNAL LOCK RING PLIERS-STRAIGHT - chrom-vanadium steel - plastic handle

DIN 5254A

							€
0505.014	140	8 ÷ 25	1,3	102	6	8011578917890	10,95
0505.018	180	19 ÷ 60	1,8	180	6	8011578917920	12,00
0505.022	220	40 ÷ 100	2,3	258	6	8011578917951	15,90
0505.032	320	85 ÷ 200	3,2	490	2	8011578943462	20,55







506 PINZA PER ANELLI ELASTICI ESTERNI BECCHI PIEGATI - acciaio chrom-vanadium - impugnatura plasticata
 EXTERNAL LOCK RING PLIERS-BENT - chrom-vanadium steel - plastic handle

DIN 5254B

							€
0506.013	130	8 ÷ 25	1,3	102	6	8011578917982	11,60
0506.017	170	19 ÷ 60	1,8	180	6	8011578918019	12,60
0506.021	210	40 ÷ 100	2,3	264	6	8011578918040	16,85
0506.031	310	85 ÷ 200	3,2	502	2	8011578947668	21,45



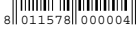

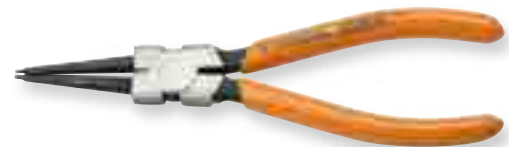

510 PINZA PER ANELLI ELASTICI INTERNI BECCHI DIRITTI - acciaio chrom-vanadium - impugnatura plasticata
 INTERNAL LOCK RING PLIERS-STRAIGHT - chrom-vanadium steel - plastic handle

DIN 5256C

							€
0510.014	140	8 ÷ 25	1,3	100	6	8011578918071	10,40
0510.018	180	19 ÷ 60	1,8	166	6	8011578918101	11,45
0510.022	220	40 ÷ 100	2,3	262	6	8011578918132	15,50
0510.032	320	85 ÷ 200	3,2	433	2	8011578943486	19,95

511 PINZA PER ANELLI ELASTICI INTERNI BECCHI PIEGATI - acciaio chrom-vanadium - impugnatura plasticata
 INTERNAL LOCK RING PLIERS-BENT - chrom-vanadium steel - plastic handle



DIN 5256D

							€
0511.013	130	8 ÷ 25	1,3	106	6	8011578918163	10,95
0511.017	170	19 ÷ 60	1,8	156	6	8011578918194	12,20
0511.021	210	40 ÷ 100	2,3	268	6	8011578918224	16,30
0511.031	310	85 ÷ 200	3,2	414	2	8011578947682	21,05

512A ESP. 36 PINZE PER ANELLI ELASTICI - metallo
 DISPLAY STAND 36 LOCK RING PLIERS - metal

Contenuto-content:



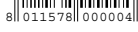

 0505.014 140 Nr. 6 0506.017 170 Nr. 6 0510.018 180 Nr. 6
 0505.018 180 Nr. 6 0510.014 140 Nr. 6 0511.017 170 Nr. 6

					€
0512.110	475 x 215 x 180		9500	8011578512002	417,60
0439.220	vuoto - empty		4150	8011578916008	45,00

512.900 ESP. IN CARTONE 18 PINZE ANELLI
 CARTON DESK DIS. 18 PLIERS CIRCLIP

Contenuto-content:

 0505.018 Nr. 6
 0506.017 Nr. 3
 0510.018 Nr. 6
 0511.017 Nr. 3

					€
0512.900	260 x 260 x 260		3800	8011578947705	215,10

513 PINZA PER ANELLI ELASTICI EST. BECCHI DIR. - PROFESSIONALE - INDUSTRIA - acciaio chrom-vanadium - imp. plasticata
 EXTERNAL LOCK RING PLIERS-STRAIGHT - PROFESSIONAL - INDUSTRIAL - chrom-vanadium steel - plastic handle



Punte forgiate
 Forget tips

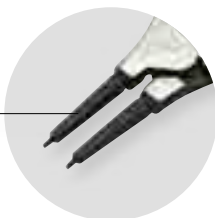

DIN 5254A

Icon	Model	Length	Tip Ø	Tip Width	Weight	Units	Barcode	Price
	0513.014	140	8 ÷ 25	1,3	102	6	8011578976620	13,45 new
	0513.018	180	19 ÷ 60	1,8	180	6	8011578976644	14,65 new
	0513.022	220	40 ÷ 100	2,3	258	6	8011578976668	18,85 new

514 PINZA PER ANELLI ELASTICI EST. BECCHI PIEG. - PROFESSIONALE - INDUSTRIA - acciaio chrom-vanadium - imp. plasticata
 EXTERNAL LOCK RING PLIERS-BENT - PROFESSIONAL - INDUSTRIAL - chrom-vanadium steel - plastic handle



DIN 5254B

Icon	Model	Length	Tip Ø	Tip Width	Weight	Units	Barcode	Price
	0514.013	130	8 ÷ 25	1,3	102	6	8011578976682	14,20 new
	0514.017	170	19 ÷ 60	1,8	180	6	8011578976705	15,25 new
	0514.021	210	40 ÷ 100	2,3	264	6	8011578976729	19,95 new



515 PINZA PER ANELLI ELASTICI INT. BECCHI DIR. - PROFESSIONALE - INDUSTRIA - acciaio chrom-vanadium - imp. plasticata
 INTERNAL LOCK RING PLIERS-STRAIGHT - PROFESSIONAL - INDUSTRIAL - chrom-vanadium steel - plastic handle



DIN 5256C

Icon	Model	Length	Tip Ø	Tip Width	Weight	Units	Barcode	Price
	0515.014	140	8 ÷ 25	1,3	100	6	8011578976842	12,70 new
	0515.018	180	19 ÷ 60	1,8	166	6	8011578976866	13,80 new
	0515.022	220	40 ÷ 100	2,3	262	6	8011578976880	18,00 new



516 PINZA PER ANELLI ELASTICI INT. BECCHI PIEG. - PROFESSIONALE - INDUSTRIA - acciaio chrom-vanadium - imp. plasticata
 INTERNAL LOCK RING PLIERS-BENT - PROFESSIONAL - INDUSTRIAL - chrom-vanadium steel - plastic handle



DIN 5256D

Icon	Model	Length	Tip Ø	Tip Width	Weight	Units	Barcode	Price
	0516.013	130	8 ÷ 25	1,3	106	6	8011578976743	13,35 new
	0516.017	170	19 ÷ 60	1,8	156	6	8011578976767	14,40 new
	0516.021	210	40 ÷ 100	2,3	268	6	8011578976781	19,10 new



517A ESP. 36 PINZE PER ANELLI ELASTICI - metallo
 DISPLAY STAND 36 LOCK RING PLIERS - metal



Contenuto-content:

0513.014	140	Nr. 6	0514.017	170	Nr. 6	0515.018	180	Nr. 6
0513.018	180	Nr. 6	0515.014	140	Nr. 6	0516.017	170	Nr. 6

Icon	Model	Dimensions	Weight	Barcode	Price
	0517.110	475 x 215 x 180	9500	8011578976804	505,50
	0439.220	vuoto - empty	4150	8011578916008	45,00

517.900 ESP. IN CARTONE 18 PINZE ANELLI
 CARTON DESK DIS. 18 PLIERS CIRCLIP



Contenuto-content:

0513.018	Nr. 6
0514.017	Nr. 3
0515.018	Nr. 6
0516.017	Nr. 3

Icon	Model	Dimensions	Weight	Barcode	Price
	0517.900	260 x 260 x 260	3800	8011578976828	259,65



0010.015

0012.015



518.010

PINZA LUNGHISSIMA - RETTA - finitura lucida - impugnatura plasticata
 LONG PLIERS - STRAIGHT - polish finish - plastic handle











0518.010 280 3 x 3.5 85 300 2 8011578971168 € 15,40

518.020

PINZA LUNGHISSIMA - CURVA - finitura lucida - impugnatura plasticata
 LONG PLIERS - BEND - polish finish - plastic handle











0518.020 280 3 x 3.5 85 300 2 8011578971182 € 15,40







520

PINZA PER ELETTRONICA BECCHI PIATTI - acciaio chrom-vanadium finitura lucida
 ELECTRONIC PLIERS-FLAT NOSE - chrom-vanadium polished finish steel

COMOGRIP
 MUNDIAL

Impugnatura isolata morbida bicomponente in gomma-pvc
 Insulated bicomponent soft handle in rubber-pvc















0520.010 120 66 6 8011578918552 € 6,50

522

PINZA PER ELETTRONICA BECCHI TONDI
 ELECTRONIC PLIERS-ROUND NOSE













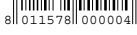

0522.010 120 70 6 8011578918583 € 6,50

524

PINZA PER ELETTRONICA BECCHI MEZZOTONDI PIEGATI
 ELECTRONIC PLIERS-BENT HALF ROUND NOSE



0524.010 120 66 6 8011578918613 € 6,50

525 PINZA PER ELETTRONICA BECCHI MEZZOTONDI LUNGI
 ELECTRONIC PLIERS-LONG HALF ROUND NOSE



0525.010

 150



 78 6

 80115781100004



6,60
526 TRONCHESE TAGLIO DIAGONALE PER ELETTRONICA
 ELECTRONIC DIAGONAL CUTTER



0526.010

 115



 72 6

 80115781100004



6,60
527 TRONCHESE TAGLIO FRONTALE PER ELETTRONICA
 ELECTRONIC FRONT CUTTER



0527.010

 115



 70 6

 80115781100004



6,60
528 PINZA UNIVERSALE PER ELETTRONICA BECCHI MEZZOTONDI CON TAGLIANTE
 ELECTRONIC COMBINATION PLIERS-HALF ROUND NOSE WITH CUTTER



0528.010

 120



 78 6

 80115781100004



6,60
529.900 ESPOSITORE IN CARTONE 18 PINZE ELETTRONICA
 CARTON DESK DISPLAY 18 PLIERS ELECTRONIC

Contenuto-content:

0520.010	Nr. 2	0526.010	Nr. 6
0522.010	Nr. 2	0527.010	Nr. 2
0524.010	Nr. 2	0528.010	Nr. 2
0525.010	Nr. 2		



0529.900 260 x 260 x 260



 1980

 8011578947729



118,20

533 TRONCHESE PER ELETTRONICA TESTA ARROTONDATA - PROFESSIONALE - acciaio chrom-vanadium finitura lucida
 ELECTRONIC DIAGONAL CUTTER ROUND TIP - PROFESSIONAL - chrom-vanadium polished finish steel



 **0533.010**  125   80 **6**  8011578 000004  **14,60**

534 TRONCHESE ELETTRONICA TESTE APPUNTITE - PROFESSIONALE - acciaio chrom-vanadium finitura lucida
 ELECTRONIC DIAGONAL CUTTER STRAIGHT TIP - PROFESSIONAL - chrom-vanadium polished finish steel



 **0534.010**  125   68 **6**  8011578 000004  **14,60**

532A PINZETTA PLASTICATA - punte arrotondate rette
 TWEEZERS WITH PLAST. HANDLE - str. round tips



 **0532.110**  160   30 **6**  8011578 000004  **3,80**

540B PINZETTA - punte arrotondate curve - fin. nic.
 TWEEZERS - bent round tips - nic. pl. fin.



 **0540.210**  150   28 **6**  8011578 000004  **4,20**

532B PINZETTA PLASTICATA - punte arrotondate curve
 TWEEZERS WITH PLAST. HANDLE - bent round tips



 **0532.210**  155   32 **6**  8011578 000004  **3,90**

541B PINZETTA AUTOBLOCCANTE - punte curve
 TWEEZERS SELF-LOCKING - bent tips



 **0541.210**  165   30 **6**  8011578 000004  **5,00**

540A PINZETTA - punte arrotondate rette - fin. nic.
 TWEEZERS - str. round tips - nick. plat. fin.



 **0540.110**  150   24 **6**  8011578 000004  **4,00**

558 PUNTA A TRACCIARE
 SCRIBER





 **0558.010**  150   40 **12**  8011578 000004  **4,70**

544 SERIE 3 PINZETTE PLASTICATE
 SET 3 TWEEZERS WITH PLAST. HANDLE

Contenuto-content:
 0532.110
 0532.210
 0541.210

0544.010

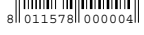

  
 90 1 8011578974848 € **12,70**



544 SERIE 2 PINZETTE
 SET 2 TWEEZERS

Contenuto-content:
 0540.110
 0540.210

0544.020



  
 56 1 8011578974862 € **8,20**



552 PINZA FUSTELLATRICE
 PUNCH PLIER

Diametro fustelle - punch diameter:
 mm 2-2,5-3-3,5-4-5

 
0552.010 220



  
 290 2 8011578965723 € **9,75**



553 PINZA FUSTELLATRICE DOPPIA LEVA
 DOUBLE LEVER PUNCH PLIER

Diametro fustelle - punch diameter:
 mm 2-2,5-3-3,5-4-5

 
0553.010 240

  
 380 2 8011578965747 € **17,50**



555.010

PINZA PUNZONATRICE PER ASSEMBLAGGIO MONTANTI frontale - CARTONGESSO
PLIERS HOLE PUNCH front - DRYWALL (PLATTER BOARD)

capacità punzonatura - punch capacity mm 0,8 + mm 0,8

     €

0555.010 315 660 2 8011578971205 22,75



555.020

PINZA PUNZONATRICE PER ASSEMBLAGGIO MONTANTI laterale - CARTONGESSO
PLIERS HOLE PUNCH - DRYWALL

capacità punzonatura - punch capacity mm 0,8 + mm 0,8

     €

0555.020 340 880 2 8011578971229 36,65



555.030

PINZA PUNZONATRICE PER ASSEMBLAGGIO DOPPIA LEVA (UNA SOLA MANO) - CARTONGESSO
PLIERS HOLE PUNCH - DRYWALL

capacità punzonatura - punch capacity mm 0,8 + mm 0,8

     €

0555.030 240 480 2 8011578971243 33,30



555.040

PINZA FORATRICE FORO RETTANGOLARE MONTANTI - CARTONGESSO
PLIERS HOLE SLOT - DRYWALL

     €

0555.040 240 15 x 4 477 2 8011578971267 44,40



555.050

PINZA PIEGATRICE LAMIERA PIATTA larghezza mm 80 x 30 DOPPIA LEVA
PLIERS BENDING FOR SHEETS mm 80 x 30

     €

0555.050 230 80 x 30 600 2 8011578971281 34,34



555.060

PINZA STRINGITUBO LAMIERA 5 DENTI DOPPIA LEVA
PLIERS 5 BLADES CRIMPER

     €

0555.060 240 440 2 8011578971304 22,20



559 CESCOIA TIPO ITALIA - acciaio finitura lucida - impugnatura plasticata
 ITALIAN PATTERN TIN SNIP - polished finish steel - plastic handle

Model	Length (mm)	Weight (g)	Quantity	Barcode	Price (€)
0559.022	220	368	2	8011578919276	19,70
0559.024	240	480	2	8011578919306	21,50
0559.026	260	500	2	8011578919337	23,10
0559.030	300	796	2	8011578919368	28,20

560 CESCOIA TIPO AMERICA - acciaio finitura lucida - impugnatura plasticata
 AMERICAN PATTERN TIN SNIP - polished finish steel - plastic handle

Model	Length (mm)	Weight (g)	Quantity	Barcode	Price (€)
0560.020	200	286	2	8011578919399	12,50
0560.025	250	456	2	8011578919429	15,35
0560.030	300	728	2	8011578919450	19,60

561 CESCOIA DOPPIA LEVA TAGLIO DESTRO - PROFESSIONALE
 LEVER TIN SNIP - RIGHT CUT - PROFESSIONAL

taglio lamiera - metal sheet cut mm. 1,8
 taglio lamiera inox - stainless steel sheet cut mm. 1,2

Model	Length (mm)	Weight (g)	Quantity	Barcode	Price (€)
0561.010	250	480	2	8011578944063	15,55

562 CESCOIA DOPPIA LEVA TAGLIO SINISTRO - PROFESSIONALE
 LEVER TIN SNIP - LEFT CUT - PROFESSIONAL

taglio lamiera - metal sheet cut mm. 1,8
 taglio lamiera inox - stainless steel sheet cut mm. 1,2

Model	Length (mm)	Weight (g)	Quantity	Barcode	Price (€)
0562.010	250	475	2	8011578944087	15,55

563 CESCOIA DOPPIA LEVA TAGLIO DRITTO - PROFESSIONALE
 LEVER TIN SNIP - STRAIGHT CUT - PROFESSIONAL

taglio lamiera - metal sheet cut mm. 1,8
 taglio lamiera inox - stainless steel sheet cut mm. 1,2

Model	Length (mm)	Weight (g)	Quantity	Barcode	Price (€)
0563.010	250	470	2	8011578944100	15,55



molla di ricambio per cesoia - spare spring 561- 562 - 563 - 564 - 565 -566 - 567 - 568:
 0563.210 30 2 8011578971823 1,70



564 **CESOIA DOPPIA LEVA TAGLIO DESTRO - acciaio chrom-vanadium - impugnatura isolata**
LEVER TIN SNIP - RIGHT CUT - chrom-vanadium steel - insulated handle

taglio lamiera - metal sheet cut mm. 1,5
 taglio lamiera inox - stainless steel sheet cut mm. 1,0



 **0564.010**  250   **360 2**  8011578919481 € **13,15**

565 **CESOIA DOPPIA LEVA TAGLIO SINISTRO - acciaio chrom-vanadium - impugnatura isolata**
LEVER TIN SNIP - LEFT CUT - chrom-vanadium steel - insulated handle

taglio lamiera - metal sheet cut mm. 1,5
 taglio lamiera inox - stainless steel sheet cut mm. 1,0



 **0565.010**  250   **352 2**  8011578919511 € **13,15**

566 **CESOIA DOPPIA LEVA TAGLIO DIRITTO - acciaio chrom-vanadium - impugnatura isolata**
LEVER TIN SNIP - STRAIGHT CUT - chrom-vanadium steel - insulated handle

taglio lamiera - metal sheet cut mm. 1,5
 taglio lamiera inox - stainless steel sheet cut mm. 1,0



 **0566.010**  250   **368 2**  8011578919542 € **13,15**

567 **CESOIA DOPPIA LEVA - taglio passante - destro - professionale**
LEVER TIN SNIP CUT - through cuts - right - professional

taglio lamiera - metal sheet cut mm. 1,8
 taglio lamiera inox - stainless steel sheet cut mm. 1,2



 **0567.010**  250   **506 2**  8011578934743 € **21,50**

568 **CESOIA DOPPIA LEVA - taglio passante - sinistro - professionale**
LEVER TIN SNIP CUT - through cuts - left - professional



taglio lamiera - metal sheet cut mm. 1,8
 taglio lamiera inox - stainless steel sheet cut mm. 1,2



 **0568.010**  250   **495 2**  8011578934767 € **21,50**

569 CESCOIA RODITORE PROFESSIONALE
 NIBBLER - PROFESSIONAL

taglio lamiera - metal sheet cut mm. 1,2
 taglio lamiera inox - stainless steel sheet cut mm. 1,0

Icona	Descrizione	Quantità	Unità	Barcode	Prezzo
	250	486	2	8011578934781	19,90
	lama-blade	50	1	8011578971144	5,25
	molla-spring	30	1	8011578971847	1,80

570 COLTELLO PER ELETTRICISTI
 KNIFE FOR ELECTRICIANS

Icona	Descrizione	Quantità	Unità	Barcode	Prezzo
	80	78	12	8011578919573	7,10

572 RIVETTATRICE PROFESSIONALE
 RIVETER - PROFESSIONAL

Per rivetti - rivets
 mm. 2,4 - 3,0 - 3,2 - 4,0 - 4,8





Icona	Descrizione	Quantità	Unità	Barcode	Prezzo
	260	555	2	8011578947743	18,95



574.1

LIMA PIATTA PARALLELA - taglio mezzo dolce
 FILE - FLAT - cut second







Icona	Lunghezza	Quantità	Barra	Numero	Prezzo
	↔ L ↔				€
0574.080	150-6"	180	2	8011578973209	7,55
0574.090	200-8"	200	2	8011578963804	8,75
0574.100	250-10"	330	2	8011578940027	11,90

574.2

LIMA MEZZO TONDA - taglio mezzo dolce
 FILE - HALF ROUND - cut second







Icona	Lunghezza	Quantità	Barra	Numero	Prezzo
	↔ L ↔				€
0574.180	150-6"	180	2	8011578973223	8,75
0574.190	200-8"	210	2	8011578963828	10,00
0574.200	250-10"	343	2	8011578940041	12,75

574.3

LIMA TONDA - taglio mezzo dolce
 FILE - ROUND - cut second







Icona	Lunghezza	Ø	Quantità	Barra	Numero	Prezzo
	↔ L ↔	∅				€
0574.280	150-6"	mm 8	180	2	8011578973247	7,55
0574.290	200-8"	mm 8	126	2	8011578963842	8,20
0574.300	250-10"	mm 9	226	2	8011578940065	10,30

574.4

LIMA TRIANGOLARE - taglio mezzo dolce
 FILE - TRIANGULAR - cut second







Icona	Lunghezza	Quantità	Barra	Numero	Prezzo
	↔ L ↔				€
0574.380	150-6"	180	2	8011578973261	7,55
0574.390	200-8"	198	2	8011578963866	8,65
0574.400	250-10"	306	2	8011578940881	11,55

574.5

LIMA QUADRA - taglio mezzo dolce
 FILE - SQUARE - cut second







					€
0574.480	150-6"	140	2	8011578973285	7,55
0574.490	200-8"	140	2	8011578963880	8,55
0574.500	250-10"	238	2	8011578940904	11,20

574.8

RASPA PER LEGNO MEZZO TONDA - taglio mezzo dolce
 RASP FOR WOOD - HALF ROUND - cut second



					€
0574.780	150-6"	180	2	8011578973308	7,55
0574.790	200-8"	196	2	8011578963903	8,20
0574.800	250-10"	356	2	8011578940928	10,90

574.990

SERIE 4 LIME
 SET 4 FILES





Contenuto-content:
 0574.090 200 0574.290 200 0574.190 200 0574.390 200

				€
0574.990	800	1	8011578963927	39,20

575...

LIMA PER CATENE MOTOSEGHE
 FILE FOR CHAIN SAW



					€
0575.040	4.0 x 200	110	2	8011578971328	8,00
0575.080	4.8 x 200	115	2	8011578971342	8,00



593Z ARCHETTO PROFESSIONALE IMPUGNATURA ERGONOMICA IN ALLUMINIO E ACCIAIO - Lama HSS 12"
 PROFESSIONAL STEEL AND ALUMINIUM HACKSAW ERGONOMIC HANDLE - HSS blade 12"

GOMMOGRIP
MUNDIAL Impugnatura morbida bicomponente.
 Soft bicomponent handle.

Pro
 INDUSTRIAL



 0593.910  12"  700  6  8011578943622 € 28,50



594 ARCHETTO PROFESSIONALE IMPUGNATURA IN LEGNO - Lama HSS 12"
 PROFESSIONAL HACKSAW WOOD HANDLE - HSS blade 12"



 0594.010  12"  650  6  8011578921071 € 13,90

595 ARCHETTO IMPUGNATURA IN LEGNO - Lama HSS 12"
 HACKSAW WOOD HANDLE - HSS blade 12"



 0595.010  12"  374  6  8011578921101 € 9,30

596 ARCHETTO IMPUGNATURA ERGONOMICA - Lama HSS 12"
 HACKSAW ERGONOMIC HANDLE - HSS blade 12"



 0596.010  12"  410  6  8011578921132 € 12,80

597 SEGHETTO PORTALAMA
MINI HACKSAW

	← L →				€
0597.910	150	6	6	8011578970505	11,90

598 ARCHETTO PUK - finitura verniciata
PUK HACKSAW - varnished finish

	← L →				€
0598.010	6"	92	12	8011578921194	2,30

598Z SEGHETTO MINI IMPUGNATURA IN ALLUMINIO - puk
MINI HACKSAW ALUMINIUM HANDLE - puk

	← L →				€
0598.910	6"	118	6	8011578943646	6,95

599A LAMA PUK PER FERRO
PUK BLADE FOR IRON

 prezzo per una lama
price for one blade

	← L →				€
0599.110	6"	2	12	8011578921224	0,75

599B LAMA PUK PER LEGNO
PUK BLADE FOR WOOD

 prezzo per una lama
price for one blade

	← L →				€
0599.210	6"	2	12	8011578921255	0,65

599D LAMA HSS BIMETAL 12" TPI 24
HSS BIMETAL BLADE 12" TPI 24





 prezzo per una lama
price for one blade

	← L →				€
0599.410	12"	18	10	8011578921286	2,20

600

SCALPELLO PER MECCANICI FORGIATO - acciaio chrom-vanadium finitura cromata
CHISEL FOR MECHANIC - FORGED - chrom-vanadium steel chrome plated finish

DIN 6453



	L				€
	↔ L ↔				
0600.015	150 - 20	178	6	8011578921316	10,20
0600.020	200 - 24	324	6	8011578921378	18,35
0600.025	250 - 28	492	6	8011578921408	25,25
0600.030	300 - 34	685	6	8011578963484	34,45



601

SCALPELLO PER MECCANICI CON PARAMANO - acciaio chrom-vanadium finitura cromata
CHISEL FOR MECHANIC WITH HAND PROTECTION - chrom-vanadium steel chrome plated finish

DIN 6453





	L				€
	↔ L ↔				
0601.025	250 - 28	582	2	8011578960988	30,30
0601.030	300 - 34	770	2	8011578965686	39,50



601A

PARAMANO per art. 600
HAND PROTECTION - for art. 600

DIN 6453

	L				€	
	↔ L ↔					
0601.925	118	per - for 250	82	2	8011578961008	5,05
0601.930	120	per - for 300	84	2	8011578965709	5,05



612 SCALPELLO PER MECCANICI - acciaio chrom-vanadium finitura cromata

CHISEL FOR MECHANIC - chrom-vanadium steel chrome-plated finish

DIN 6453

Icona	●	←-L-→	👤	📦	Barcode	€
0612.013	9	125	50	12	8011578921859	4,35
0612.016	12	150	142	12	8011578921880	5,40



614 UNGHIETTA PER MECCANICI - acciaio chrom-vanadium finitura cromata

CHISEL CROSS FOR MECHANIC - chrom-vanadium steel chrome plated finish

DIN 6451

Icona	●	←-L-→	👤	📦	Barcode	€
0614.013	9	125	44	12	8011578921910	5,00
0614.016	12	150	128	12	8011578921941	6,15



615 PUNZONE PER MECCANICI - acciaio chrom-vanadium finitura cromata

DRIFT PUNCH FOR MECHANIC - chrom-vanadium steel chrome plated finish

DIN 5458

Icona	∅	●	←-L-→	👤	📦	Barcode	€
0615.100	1	9	125	58	12	8011578921972	3,75
0615.200	2	9	125	66	12	8011578922009	3,75
0615.300	3	9	125	68	12	8011578922030	3,75
0615.400	4	12	150	116	12	8011578922061	4,60
0615.500	5	12	150	106	12	8011578922092	4,60
0615.600	6	12	150	126	12	8011578922122	4,60



616 PUNZONE PER CENTRI PER MECCANICI - acciaio chrom-vanadium finitura cromata

CENTRE PUNCH FOR MECHANIC - chrom-vanadium steel chrome plated finish

DIN 7250

Icona	∅	●	←-L-→	👤	📦	Barcode	€
0616.012	4	10	125	58	12	8011578922153	4,15
0616.015	5	13	150	114	12	8011578922184	4,75



616Z PUNZONE PER CENTRI AUTOMATICO - acciaio chrom-vanadium finitura cromata

AUTOMATIC CENTRE PUNCH - chrom-vanadium steel chrome plated finish

Icona	←-L-→	👤	📦	Barcode	€
0616.910	125	60	6	8011578961022	11,95



617 CACCIASPINE PER MECCANICI - acciaio chrom-vanadium finitura cromata

PIN PUNCH FOR MECHANIC - chrom-vanadium steel chrome plated finish

DIN 6450

Icona	∅	●	←-L-→	👤	📦	Barcode	€
0617.020	2	30	110	40	12	8011578922214	4,00
0617.030	3	40	130	42	12	8011578922245	4,25
0617.040	4	50	145	76	12	8011578922276	4,30
0617.050	5	60	165	72	12	8011578922306	4,70
0617.060	6	65	180	138	12	8011578922337	5,40
0617.080	8	70	200	164	12	8011578922368	5,85



617A SERIE 6 CACCIASPINE - busta
 SET 6 PIN PUNCHES - envelope

Contenuto-content:

0617.020	2	0617.050	5
0617.030	3	0617.060	6
0617.040	4	0617.080	8

					
0617.110	590	568	6	8011578617189	27,10



620 SERIE 6 SCALPELLI E PUNZONI - busta
 SET 6 CHISELS AND DRIFT PUNCHES - envelope

Contenuto-content:

0612.013	125	0615.200	2
0612.016	150	0615.400	4
0614.013	125	0616.012	125



					
0620.010	490	530	6	8011578620004	27,00



623 ESPOSITORE 63 PUNZONI-CACCIASPINE-SCALPELLI - metallo
 DISPLAY STAND 63 DRIFT-PIN PUNCHES-CHISELS - metal

Contenuto-content:







0600.015	Nr. 3	0614.016	Nr. 3	0615.600	Nr. 3	0617.050	Nr. 3
0600.020	Nr. 3	0615.100	Nr. 3	0616.012	Nr. 3	0617.060	Nr. 3
0600.025	Nr. 3	0615.200	Nr. 3	0616.015	Nr. 3	0617.080	Nr. 3
0612.013	Nr. 3	0615.300	Nr. 3	0617.020	Nr. 3		
0612.016	Nr. 3	0615.400	Nr. 3	0617.030	Nr. 3		
0614.013	Nr. 3	0615.500	Nr. 3	0617.040	Nr. 3		

				
0623.010	440 x 210 x 60	14000	8011578623104	411,45
0623.210	vuoto - empty	1000	8011578960407	35,00



624 SCALPELLO PER ELETTRICISTI - acciaio chrom-vanadium finitura verniciata
 CHISEL FOR ELECTRICIANS - chrom-vanadium steel varnished finish

EX 609

						
0624.120	8	200	80	12	8011578921460	3,70
0624.220	10	200	128	12	8011578921491	4,00
0624.225	10	250	158	12	8011578921521	4,05
0624.230	10	300	192	12	8011578921552	4,75



624.5 PUNTA PER ELETTRICISTI - acciaio chrom-vanadium finitura verniciata
 CHISEL TIP FOR ELECTRICIANS - chrom-vanadium steel varnished finish

EX 610

						
0624.525	10	250	154	12	8011578921736	4,05



625 SCALPELLO PER MURATORE - acciaio finitura verniciata

CHISEL FOR MASON - steel varnished finish



DIN 7254

Icona	Ø	←-L→	Icona	Icona	Barcode	€
	16	250			80115781000004	
0625.025	16	250	400	6	8011578922511	4,05
0625.030	16	300	498	6	8011578922542	4,85
0625.035	16	350	500	6	8011578922573	5,70
0625.040	16	400	666	6	8011578922603	6,45

626 PUNTA PER MURATORE - acciaio finitura verniciata

CHISEL TIP FOR MASON - steel varnished finish



DIN 7256

Icona	Ø	←-L→	Icona	Icona	Barcode	€
	16	250	386	6	8011578922634	4,05
0626.025	16	250	386	6	8011578922634	4,05
0626.030	16	300	456	6	8011578922665	4,85
0626.035	16	350	568	6	8011578922696	5,70
0626.040	16	400	656	6	8011578922726	6,45

628 SCALPELLO PER MURATORE RIAFFILABILE - acciaio finitura verniciata

CHISEL FOR MASON - RE-SHARPABLE - steel varnished finish



Icona	Ø	←-L→	Icona	Icona	Barcode	€
	16	300	412	6	8011578922788	9,00
0628.030	16	300	412	6	8011578922788	9,00
0628.035	16	350	502	6	8011578922818	10,05

629 PUNTA PER MURATORE RIAFFILABILE - acciaio finitura verniciata

CHISEL TIP FOR MASON - RE-SHARPABLE - steel varnished finish



Icona	Ø	←-L→	Icona	Icona	Barcode	€
	16	300	400	6	8011578922849	9,00
0629.030	16	300	400	6	8011578922849	9,00
0629.035	16	350	472	6	8011578922870	10,05

629A IMPUGNATURA PARAMANO per art. 625 - 626 - 628 - 629

HAND PROTECTION HANDLE for art. 625 - 626 - 628 - 629



Icona	Ø	Icona	Icona	Barcode	€
	16	110	6	8011578922900	2,20
0629.110	16	110	6	8011578922900	2,20

630 SCALPELLO PER MURATORE RIAFFILABILE CON PARAMANO
 CHISEL FOR MASON WITH HAND PROTECTION



Icona	Ø	L	Icona	Icona	Barcode	€
	16	300			8011578922931	11,55
	16	350			8011578922962	12,60

631 PUNTA PER MURATORE RIAFFILABILE CON PARAMANO - acciaio finitura cromata
 CHISEL TIP FOR MASON WITH HAND PROTECTION - RE-SHARPABLE - steel chrome finish



Icona	Ø	L	Icona	Icona	Barcode	€
	16	300			8011578922993	11,55
	16	350			8011578923020	12,60

633 SCALPELLO PER MURATORE TIPO LARGO - acciaio finitura verniciata
 CHISEL FOR MASON - WIDE - steel varnished finish



Icona	Icona	L	Icona	Icona	Barcode	€
		240			8011578923051	11,90
		240			8011578923082	12,10

635 ESPOSITORE 48 SCALPELLI E PUNTE MURATORE - metallo
 DISPLAY STAND 48 CHISEL AND CHISEL TIP FOR MASON - metal



Contenuto-content:

- 0625.030 Nr. 6
- 0625.035 Nr. 6
- 0626.030 Nr. 6
- 0626.035 Nr. 6
- 0628.030 Nr. 6
- 0628.035 Nr. 6
- 0629.030 Nr. 6
- 0629.035 Nr. 6

Icona	L	Icona	Barcode	€
	270 x 250 x 270		8011578635008	355,20
	vuoto - empty		8011578960421	35,80

638 PIOMBO CILINDRICO - finitura verniciata
 CYLINDRIC LEAD - varnished finish

📄	Gr.	📦	📄	€
0638.010	100	12	8011578923112	4,00
0638.020	200	12	8011578923143	4,75
0638.030	300	6	8011578923174	5,95
0638.040	400	6	8011578923204	6,80
0638.050	500	6	8011578923235	7,90
0638.080	800	2	8011578923266	10,90

638A PIASTRA PER PIOMBI CILINDRICI
 PLATE FOR CYLINDRIC LEAD

📄	per/for	Gr.	📦	€
0638.110	100		6	0,80
0638.120	200		6	0,80
0638.130	300		6	0,85
0638.140	400		6	0,85
0638.150	500		6	0,85
0638.180	800		6	1,05

638Z PIOMBO + FILO + PIASTRA - finitura verniciata
 LEAD + ROPE + PLATE - varnished finish

📄	Gr.	📦	€
0638.910	100	6	5,80
0638.920	200	6	6,55
0638.930	300	6	7,80
0638.940	400	6	8,65

640 PIOMBO A PERA - finitura verniciata
 LEAD - varnished finish

📄	Gr.	📦	€
0640.020	200	6	7,75
0640.030	300	6	8,60
0640.040	400	6	9,45
0640.050	500	6	10,40

640A PIASTRA PER PIOMBI A PERA
 PLATE FOR LEAD

📄	per/for	Gr.	📦	€
0640.120	200		6	0,75
0640.130	300		6	0,85
0640.140	400		6	0,95
0640.150	500		6	0,95

671 APRICASSE - finitura verniciata
 LEVER - varnished finish

📄	—L—	📦	€
0671.010	400	628 6	7,60

672 LEVACHIODO A COLLO DI CIGNO - finitura verniciata
 WRECKING BARS - varnished finish

📄	—L—	📦	€
0672.010	600	1410 6	11,55



677 **FORBICI PROFESSIONALI per elettricisti TAGLIA-SPELA-CRIMPA - lame acciaio inox con microdentatura - imp. isolata**
PROFESSIONAL SCISSORS for electricians CUT-STRIP-CRIMP - stainless steel anti-slipping blades - insulated handle



- **Lame con doppio tagliacavi 70 mm²**
Blades with double cable cutter 70 mm²
- **Acciaio inox MO-VA durezza HRC 58-60**
MO-VA stainless steel HRC 58-60
- **Microdentata anti scivolo - Spelato 2,5 mm²**
Anti-slip micro-toothed - Wire stripping 2,5 mm²
- **Crimpatore per terminali 1-10 mm²**
Crimping for terminals 1-10 mm²



0677.010 155 116 6 801157897207 € 21,70 **new**



677.900 **ESPOSITORE IN CARTONE 18 FORBICI**
CARTON DESK DISPLAY 18 SCISSORS

Contenuto-content:
0677.010 Nr. 18

0677.900 260 x 260 x 260 2620 8011578983604 € 390,60 **new**



680 **FORBICI PROFESSIONALI MULTIUSO - lame acciaio inox con microdentatura - impugnatura isolata**
SCISSORS - PROFESSIONAL MULTI-USE - stainless steel anti-slipping blades - insulated handle



0680.010 145 80 12 8011578923747 € 6,20



680.900 **ESPOSITORE IN CARTONE 24 FORBICI**
CARTON DESK DISPLAY 24 SCISSORS

Contenuto-content:
0680.010 Nr. 24

0680.900 260 x 260 x 260 2620 8011578947767 € 148,80



683 **FORBICI PER ELETTRICISTI - bicomponente inox**
SCISSORS FOR ELECTRICIANS - bicomponent inox



0683.010 145 98 12 8011578934002 € 9,40



683.900 **ESPOSITORE IN CARTONE 24 FORBICI**
CARTON DESK DISPLAY 24 SCISSORS

Contenuto-content:
0683.010 Nr. 24

0683.900 260 x 260 x 260 2600 8011578947804 € 225,60



686A FORBICI ELETTRICISTI RETTE
 SCISSORS FOR ELECTRICIANS - STRAIGHT



     €
0686.110 145 90 12 8011578923921 **6,90**

686B FORBICI ELETTRICISTI CURVE
 SCISSORS FOR ELECTRICIANS - BENT



     €
0686.210 145 90 12 8011578923952 **7,35**

689 FORBICI ELETTRICISTI tipo STANDARD - inox
 SCISSORS FOR ELECTRICIANS - STANDARD type - stainless



     €
0689.010 140 67 12 8011578943882 **6,60**

689.900 ESPOSITORE 24 FORBICI
 DISPLAY 24 SCISSORS

Contenuto-content:
 0689.010 Nr. 24

     €
0689.900 260 x 260 x 260 2300 8011578947828 **158,40**



700 TRONCHESE TAGLIACAVI IN RAME
 CUTTER PLIERS FOR COPPER



      €
0700.010 200 16 303 6 8011578943929 **15,70**





702 TAGLIACAVI IN RAME - acciaio speciale alta resistenza al taglio - finitura verniciata - impugnatura isolata
 CUTTER PLIERS FOR COPPER CABLE - special steel high cut resistant - varnished finish - insulated handle



      €
0702.010 450 27 982 1 8011578963460 **31,60**

705 MOLLA
 SPRING



     €
0705.045 45 5 12 8011578924676 **0,90**
0705.060 60 7 12 8011578924706 **1,00**
0705.065 65 7 12 8011578924737 **1,00**
0705.070 70 8 12 8011578924768 **1,00**
0705.075 75 8 12 8011578924799 **1,10**



710 PINZA UNIVERSALE ISOLATA 1000 volt VDE - acciaio chrom-vanadium finitura cromata
 COMBINATION PLIERS - INSULATED 1000 volt VDE - chrom-vanadium steel chrome plated finish



Pro
INDUSTRIAL



 60900 =







							€
0710.018	180	5,8 x 10	36,5	300	6	8011578933005	24,90
0710.020	200	7 x 10,5	39,5	360	6	8011578933029	30,05

COMMOGRIP Impugnatura morbida bicomponente.
MUNDIAL Soft bicomponent handle.

712 PINZA BECCHI MEZZOTONDI ISOLATA 1000 volt VDE - acciaio chrom-vanadium finitura cromata
 HALF NOSE PLIERS - INSULATED 1000 volt VDE - chrom-vanadium steel chrome plated finish

Pro
INDUSTRIAL









							€
0712.016	160	3 x 2,5	61	176	6	8011578933043	18,75
0712.020	200	3 x 2,5	77	202	6	8011578933067	22,65

714 PINZA BECCHI CURVI MEZZOTONDI ISOLATA 1000 volt VDE - acciaio chrom-vanadium finitura cromata
 BENT HALF NOSE PLIERS - INSULATED 1000 volt VDE - chrom-vanadium steel chrome plated finish

Pro
INDUSTRIAL



							€
0714.016	160	3 x 2,5	61	176	6	8011578933081	19,15
0714.020	200	3 x 2,5	77	202	6	8011578933104	22,95

716 TRONCHESE TAGLIO DIAGONALE ISOLATA 1000 volt VDE - acciaio chrom-vanadium finitura cromata
 CUTTER DIAGONAL CUTTING - INSULATED 1000 volt VDE - chrom-vanadium steel chrome plated finish

Pro
INDUSTRIAL



							€
0716.016	160	20		212	6	8011578933128	23,10

728 ESPOSITORE 36 PINZE E TRONCHESI ISOLATE 1000 volt VDE DISPALY 36 PLIERS AND CUTTERS - INSULATED 1000 volt VDE

Contenuto

0710.018 Nr. 6
 0710.020 Nr. 6
 0712.016 Nr. 6
 0712.020 Nr. 6
 0714.020 Nr. 6
 0716.016 Nr. 6

 
0728.010 475 x 215 x 180

 12600

 8011578728007

854,40



730 ESPOSITORE GIRAVITI E PINZE ISOLATE 1000 volt VDE DISPLAY INSULATED SCREWDRIVERS AND PLIERS 1000 volt VDE

Contenuto-content:

0090.258 2,5 x 0,4 x 80 Nr. 9
 0090.310 3,0 x 0,5 x 100 Nr. 9
 0090.410 4,0 x 0,8 x 100 Nr. 8
 0090.512 5,5 x 1,0 x 125 Nr. 8
 0090.615 6,5 x 1,2 x 150 Nr. 7
 0090.817 8,0 x 1,6 x 150 Nr. 6
 0092.007 PH0 x 75 Nr. 9
 0092.110 PH1 x 100 Nr. 8
 0092.210 PH2 x 100 Nr. 7
 0092.315 PH3 x 150 Nr. 6
 0093.007 PZ0 x 75 Nr. 9
 0093.110 PZ1 x 100 Nr. 8
 0093.210 PZ2 x 100 Nr. 7
 0710.018 Nr. 6
 0710.020 Nr. 6
 0712.016 Nr. 6
 0712.020 Nr. 6
 0714.020 Nr. 6
 0716.016 Nr. 6

 **60900**

 
0730.010 475 x 215 x 600

 29250

 8011578730000

1.486,05



730.900 ESPOSITORE CARTONE 18 PINZE E TRONCHESI ISOLATE 1000 volt VDE CARTON DESK DISPLAY 18 PLIERS AND CUTTER - INSULATED 1000 volt VDE

Contenuto-content:

0710.018 Nr. 12
 0716.016 Nr. 3
 0712.016 Nr. 3

 
0730.900 260 x 260 x 260

 4900

 8011578947842





424,35



739 SPELAFILI AUTOMATICO FRONTALE
 FRONT AUTOMATIC WIRE STRIPPING PLIER

1,00 ÷ 3,20 mm Ø



 **0739.010**  0,25 ÷ 6,0 mm²  175  210  **2**  8011578963941  **14,30**

740 SPELAFILI AUTOMATICO
 AUTOMATIC WIRE STRIPPING PLIER



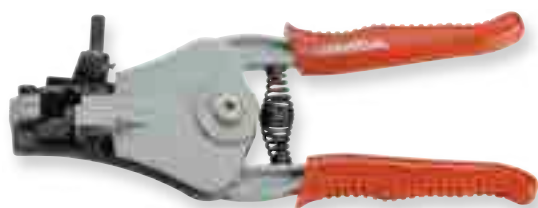









1,00 ÷ 3,20 mm Ø



 **0740.010**  0,25 ÷ 6,0 mm²  200  210  **2**  8011578943608  **14,85**



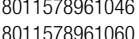









741 TAGLIACAVI A CREMAGLIERA AUTOMATICO per cavi in rame-alluminio
 RATCHETING CABLES CUTTER for copper-aluminium cable



 **0741.020**  mm 36 / 300 mm²  260  670  **1**  8011578961046  **185,50**
0741.040 mm 60 / 500 mm²  320  858  **1**  8011578961060  **259,00**

741Z TAGLIACAVI A CREMAGLIERA AUTOMATICO per cavi in rame-alluminio
 RATCHETING CABLES CUTTER for copper-aluminium cable

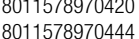

 **0741.920**  mm 32 / 240 mm²  250  670  **1**  8011578970420  **163,25**
0741.940 mm 52 / 400 mm²  270  858  **1**  8011578970444  **285,65**

750 PINZA CAPICORDA ISOLATI
 CRIMPING PLIER FOR INSULATED TERMINAL



0,5-1,5 1,5-2,5 4,0-6,0 mm² - AVG 20-10

     €
0750.010 220 578 2 8011578963965 **46,10**

751 PINZA CAPICORDA NON ISOLATI
 CRIMPING PLIER FOR NON-INSULATED TERMINAL



0,5-1,0 1,5-2,5 4,0-10,0 mm² - AWG 20-7

     €
0751.010 220 578 2 8011578963989 **46,10**

752 PINZA CAPICORDA APERTI NON ISOLATI
 CRIMPING PLIER FOR NON-INSULATED TAB AND RECEPTACLES



0,5-1,0 1,5-2,5 4,0-6,0 mm² - AWG 20-10

     €
0752.010 220 578 2 8011578964009 **46,10**

756 PINZA CAPICORDA DATI-TELEFONIA
 MODULAR PLUG CRIMPS PLIER-TELECOM



RJ10 (4) 7,65 mm
 RJ11/12 (6) 9,65 mm
 RJ45 (8) 11,68 mm

     €
0756.010 225 510 2 8011578964023 **40,50**



769 TAGLIATUBI MINI
 MINI TUBE CUTTER

Model	Ø	Info	Box	Barcode	Price
0769.015	15	259	2	8011578942724	18,60
0769.022	22	274	2	8011578942748	23,30



770 TAGLIATUBI MINI RAME E LEGHE LEGGERE mm 22 - 7/8"
 MINI TUBING CUTTER mm 22 - 7/8"

Model	Ø	Info	Box	Barcode	Price
0770.022	22 - 7/8"	99	2	8011578934804	7,25



772 TAGLIATUBI RAME E LEGHE LEGGERE mm 32 - 1 1/4"
 TUBING CUTTER mm 32 - 1 1/4"

Model	Ø	Info	Box	Barcode	Price
0772.032	32 - 1 1/4"	278	2	8011578934828	16,25



773 TAGLIATUBI TELESCOPICO 4 RULLI mm 42 - 1 5/8"
 TELESCOPIC TUBING CUTTER WITH 4 ROLLERS mm 42 - 1 5/8"

Pro
 INDUSTRIAL

- 4 RULLI
 - 4 ROLLERS

Model	Ø	Info	Box	Barcode	Price
0773.010	42	640	2	8011578967222	42,40



774 TAGLIATUBI TELESCOPICO RAME E LEGHE LEGGERE mm 32 - 1 1/4"
 TELESCOPIC TUBING CUTTER mm 32 - 1 1/4"

Pro
 INDUSTRIAL

Model	Ø	Info	Box	Barcode	Price
0774.032	32 - 1 1/4"	272	2	8011578934842	17,60



775 LAMA per 770 - 772 - 774
 SPARE BLADE for 770 - 772 - 774

Model	Size	Material	Info	Box	Barcode	Price
0775.110	18 x 3	rame - copper	3	2	8011578934866	0,65
0775.210	18 x 3	inox - stainless steel	3	2	8011578934880	3,60



776 TAGLIATUBI TELESCOPICO RAPIDO RAME E LEGHE LEGGERE mm 63 - 2 1/2"





ACTION TELESCOPIC TUBING CUTTER mm 63 - 2 1/2"



					
0776.063	63 - 2 1/2"	540	2	8011578934903	66,30

776... LAMA per 776 - 773

SPARE BLADE for 776 - 773

					
0776.110	18 x 6 rame - copper	3	2	8011578934927	0,90
0776.210	18 x 6 inox - stainless steel	3	2	8011578934941	3,65
0776.310	22 x 6 plastica - plastic	6	2	8011578934965	1,35



777 TAGLIATUBI TELESCOPICO RAPIDO PLASTICA mm 127 - 5"

ACTION TELESCOPIC TUBING CUTTER mm 127 - 5"



					
0777.127	127 - 5"	2000	1	8011578934989	160,90

777... LAMA per 777

SPARE BLADE for 777

					
0777.210	42 x 11 plastica - plastic	25	2	8011578935009	14,80



782 TAGLIATUBI PER ACCIAIO 2"







STEEL PIPE CUTTER 2"



					
0782.002	2"	2500	2	8011578935023	66,00

782... LAMA per 782





SPARE BLADE for 782

					
0782.110	31 x 19 acciaio - steel	25	2	8011578935047	3,60
0782.210	31 x 19 inox - stainless steel	23	2	8011578935061	11,90





786 TAGLIATUBI A CRICCHETTO PER PLASTICA mm 42 - 1 5/8"
 PVC QUICK RELEASE PIPE CUTTER mm 42 - 1 5/8"



	∅				€
0786.042	42	767	2	8011578940126	44,05
0786.142	lama-blade	40	1	8011578971885	5,20

790 TAGLIATUBI CRICCHETTO PER PLASTICA mm 42 - 1 5/8"
 PVC PIPE CUTTER mm 42 - 1 5/8"



	↔ L ↔				€
0790.042	42 - 1 5/8"	318	2	8011578935085	16,20
0790.142	lama-blade	50	1	8011578971908	3,85

792 TAGLIATUBI PLASTICA AUTOMATICO mm 42 - 1 5/8"
 AUTO PVC PIPE CUTTER mm 42 - 1 5/8"



	↔ L ↔				€
0792.042	42 - 1 5/8" mm 430	536	2	8011578935108	28,30

792A LAMA per 792.042
 SPARE BLADE for 792.042

				€
0792.142	74	2	8011578943028	5,65



794 TAGLIATUBI PLASTICA mm 63 - 2 1/2"
 PVC PIPE CUTTER mm 63 - 2 1/2"



	↔ L ↔				€
0794.063	63 - 2 1/2"	1074	1	8011578935122	67,40



794A LAMA per 794.063
 BLADES for 794.063

				€
0794.163	170	2	8011578943042	22,10

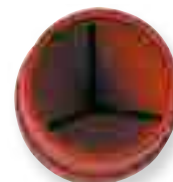

795 SBAVATUBI per interni e esterni
 REAMER for internal and external



 **0795.010** Ø 6 ÷ 40 mm   210 **2**  80115781000004  **15,50**

796.100 CHIAVE SOTTOLAVABO REVERSIBILE
 REVERSIBLE BASIN WRENCH



 **0796.100** 350   503 **2**  80115781000004  **21,40**

796.300 CHIAVE SOTTOLAVABO RUBINETTO
 BASIN WRENCH



 **0796.300** 310   474 **2**  8011578935146  **14,20**

797 CHIAVE SOTTOLAVABO RUBINETTO TELESCOPICO
 TELESCOPIC BASIN WRENCH



 **0797.300** 290   761 **2**  8011578935160  **28,40**

798 PINZA PER SIFONI
 SYPHONE PLIERS



 **0798.240** 230   255 **2**  8011578935184  **12,95**

799 PIEGATUBI mm 6-8-10
 TUBE BENDER mm 6-8-10



 **0799.010** 275   427 **1**  8011578942625  **20,50**



803 SERIE 7 MATRICI E CRICCHETTO CURVATUBI PER RAME E MULTISTRATO
 SET 7 BEND FORM AND RATCHET FOR COPPER ISOLATED TUBE

per tubi - for tube
 10 - 12 - 14 - 18 - 22

     €
0803.010 6-22 mm 2000 **1** 8011578969684 **326,10**



807 UTENSILE PER COLLETTI TUBI RAME-OTTONE-ALLUMINIO
 TOOL FOR FLARING TUBE COPPER-BRASS-ALUMINIUM

per tubi - for tube
 3/16 - 5/8

     €
0807.010 5-16 mm 740 **2** 8011578967284 **48,90**



815 CHIAVE PER PILETTE
 PLUMBERS BASIN LEVEL

     €
0815.010 42-56 mm 315 **2** 8011578967307 **49,90**



830 CHIAVE 4 APERTURE A CROCE
 CROSS KEY WRENCH

 9 in 1
  5 mm
  8 mm
  9 mm
  11/16 6-7-8-9 mm
  ADAPTER
  PH2/ 7mm

    €
0830.010 54 **2** 8011578967321 **6,50**



832 RASCHIETTO TELESCOPICO
 TELESCOPIC DEBURRING TOOL

    €
0832.010 30 **2** 8011578967345 **20,75**



833 LAMA HSS per art. 832
 HSS BLADE for art. 832

prezzo per una lama
 price for one blade

    €
0833.010 3 **10** 8011578967369 **3,65**



839 CHIAVE REGOLABILE PER IDRAULICA IN ALLUMINIO apertura mm 68
 ADJUSTABLE WRENCH ALUMINIUM open mm 68



mm 68

 **0839.010**  200  mm 68   195  80115781000004  **15,35**

840 CRICCHETTO 1/2" FEMMINA
 RATCHET 1/2" FEMALE



 **0840.010**  270   526  80115781000004  **28,40**

841 CRICCHETTO + CHIAVE GRADINI
 RATCHET + WRENCH STEP





mm 9,6 - 11,6 - 12,6 - 16,4 - 21,0

 **0841.010**   654  80115781000004  **43,50**

842 CHIAVE GRADINI RADIATORE 1/2"
 WRENCH STEP 1/2"



mm 9,6 - 11,6 - 12,6 - 16,4 - 21,0

 **0842.010**  90   128  80115781000004  **15,10**

843 RACCORDO 1/2"
 ADAPTER FROM 1/2"



 **0843.010**  35   42  80115781000004  **3,50**

847 KIT RIPARAZIONE RUBINETTI
 SET TOP RESEATER



mm 10 - 12 - 13 - 14 - 15 - 16

 **0847.010**   180  80115781000004  **17,85**



1021 SERIE CHIAVI A FORCHETTA - scatola cartone

SET DOUBLE ENDED OPEN WRENCHES - box

Pro
INDUSTRIAL

Contenuto - content:

1020.067	6-7	1020.189	18-19
1020.089	8-9	1020.202	20-22
1020.101	10-11	1020.213	21-23
1020.123	12-13	1020.247	24-27
1020.145	14-15	1020.258	25-28
1020.167	16-17	1020.302	30-32

 serie - set
12

	Pz.			€
1021.120	12	2200	8011578021092	74,70

1022 SERIE CHIAVI A FORCHETTA - busta tela avvolgibile

SET DOUBLE ENDED OPEN WRENCHES - envelope canvas roller blind

Pro
INDUSTRIAL

Contenuto - content:

1020.067	6-7	1020.145	14-15
1020.089	8-9	1020.167	16-17
1020.101	10-11	1020.189	18-19
1020.123	12-13	1020.202	20-22

 serie - set
8

	Pz.			€
1022.080	8	830	8011578022082	44,60

Pro
INDUSTRIAL

Contenuto - content:

1020.067	6-7	1020.189	18-19
1020.089	8-9	1020.202	20-22
1020.101	10-11	1020.213	21-23
1020.123	12-13	1020.247	24-27
1020.145	14-15	1020.258	25-28
1020.167	16-17	1020.302	30-32

 serie - set
12

	Pz.			€
1022.120	12	2300	8011578022129	92,00

1022.208	8	59	8011578968229	11,35
1022.212	12	155	8011578968243	17,65

 Busta vuota per 8 chiavi a forchetta - Empty envelope for 8 wrenches
 Busta vuota per 12 chiavi a forchetta - Empty envelope for 12 wrenches

1023 SERIE 8 CHIAVI A FORCHETTA - cartone

SET 8 DOUBLE ENDED OPEN WRENCHES - box

Pro
INDUSTRIAL

Contenuto - content:

1020.067	6-7	1020.145	14-15
1020.089	8-9	1020.167	16-17
1020.101	10-11	1020.189	18-19
1020.123	12-13	1020.202	20-22

 serie - set
8

	Pz.			€
1023.080	8	928	8011578023058	37,20

1031

SERIE CHIAVI COMBinate - scatola cartone
SET COMBINATION WRENCHES - box

Contenuto - content:

1030.060 6-6	1030.120 12-12	1030.180 18-18
1030.070 7-7	1030.130 13-13	1030.190 19-19
1030.080 8-8	1030.140 14-14	1030.200 20-20
1030.090 9-9	1030.150 15-15	1030.210 21-21
1030.100 10-10	1030.160 16-16	1030.220 22-22
1030.110 11-11	1030.170 17-17	

serie - set
17

Pro
INDUSTRIAL



	Pz.			€
1031.170	17	1738	8011578031053	81,70

Contenuto - content:

1030.060 6-6	1030.130 13-13	1030.200 20-20
1030.070 7-7	1030.140 14-14	1030.210 21-21
1030.080 8-8	1030.150 15-15	1030.220 22-22
1030.090 9-9	1030.160 16-16	1030.240 24-24
1030.100 10-10	1030.170 17-17	1030.270 27-27
1030.110 11-11	1030.180 18-18	1030.300 30-30
1030.120 12-12	1030.190 19-19	1030.320 32-32

serie - set
21

Pro
INDUSTRIAL



	Pz.			€
1031.210	21	3600	8011578031213	140,30

Contenuto - content:

1030.060 6-6	1030.150 15-15	1030.240 24-24
1030.070 7-7	1030.160 16-16	1030.250 25-25
1030.080 8-8	1030.170 17-17	1030.260 26-26
1030.090 9-9	1030.180 18-18	1030.270 27-27
1030.100 10-10	1030.190 19-19	1030.280 28-28
1030.110 11-11	1030.200 20-20	1030.300 30-30
1030.120 12-12	1030.210 21-21	1030.320 32-32
1030.130 13-13	1030.220 22-22	
1030.140 14-14	1030.230 23-23	

serie - set
25

Pro
INDUSTRIAL



	Pz.			€
1031.250	25	5000	8011578031237	191,70

1032

SERIE CHIAVI COMBinate - busta tela avvolgibile
SET COMBINATION WRENCHES - envelope canvas roller blind

Contenuto - content:

1030.080 8-8	1030.170 17-17
1030.090 9-9	1030.190 19-19
1030.100 10-10	
1030.110 11-11	
1030.130 13-13	
1030.140 14-14	

serie - set
8

Pro
INDUSTRIAL



	Pz.			€
1032.080	8	703	8011578032081	43,70

Contenuto - content:

1030.060 6-6	1030.120 12-12
1030.070 7-7	1030.130 13-13
1030.080 8-8	1030.140 14-14
1030.090 9-9	1030.170 17-17
1030.100 10-10	1030.190 19-19
1030.110 11-11	1030.220 22-22

serie - set
12

Pro
INDUSTRIAL



	Pz.			€
1032.120	12	1085	8011578032128	67,95

1032.250	25	5010	8011578970949	214,35
-----------------	-----------	------	---------------	---------------

1032.208	8	59	8011578968281	11,35
-----------------	----------	----	---------------	--------------

1032.212	12	103	8011578968304	17,30
-----------------	-----------	-----	---------------	--------------

1032.225	25	381	8011578971960	22,65
-----------------	-----------	-----	---------------	--------------

Busta vuota per 8 chiavi combinate - Empty envelope for 8 wrenches
 Busta vuota per 12 chiavi combinate- Empty envelope for 12 wrenches
 Busta vuota per 25 chiavi combinate- Empty envelope for 25 wrenches

1033

SERIE 9 CHIAVI COMBinate - clip in plastica compatta
SET 9 COMBINATION WRENCHES - compact plastic clip



clip in plastica compatta - a libro
 compact plastic clip



Pro
INDUSTRIAL

Contenuto - content:

1030.080 8-8	1030.140 14-14
1030.100 10-10	1030.150 15-15
1030.110 11-11	1030.170 17-17
1030.120 12-12	1030.190 19-19
1030.130 13-13	

serie - set
9



 **1033.909** Pz. **9**  838  80115781000004 € **39,80**

Pro
INDUSTRIAL

Contenuto - content:

1030.080 8-8	1030.140 14-14
1030.090 9-9	1030.150 15-15
1030.100 10-10	1030.160 16-16
1030.110 11-11	1030.170 17-17
1030.120 12-12	1030.190 19-19
1030.130 13-13	

serie - set
11

 **1033.911** Pz. **11**  1034  8011578056544 € **49,20 new**



1033

SERIE CHIAVI COMBinate - scatola cartone
SET COMBINATION WRENCHES - box

Pro
INDUSTRIAL

Contenuto - content:

1030.080 8-8	1030.130 13-13
1030.090 9-9	1030.140 14-14
1030.100 10-10	1030.170 17-17
1030.110 11-11	1030.190 19-19

serie - set
8

 **1033.080** Pz. **8**  816  8011578033095 € **36,30**



Pro
INDUSTRIAL

Contenuto - content:

1030.060 6-6	1030.120 12-12
1030.070 7-7	1030.130 13-13
1030.080 8-8	1030.140 14-14
1030.090 9-9	1030.170 17-17
1030.100 10-10	1030.190 19-19
1030.110 11-11	1030.220 22-22

serie - set
12

 **1033.120** Pz. **12**  1200  8011578033057 € **55,05**



1035

CHIAVE COMBINATA in POLLICI - acciaio chrom-vanadium finitura cromata
COMBINATION WRENCH in INCH - chrom-vanadium steel chrome plated finish



POLLICI
INCH

Icona	●	— L —	Icona	Icona	Barcode	€	
	1035.005	1/4"	102	18	2	8011578964146	3,25
	1035.008	5/16"	125	26	2	8011578964160	3,35
	1035.010	3/8"	133	30	2	8011578964184	3,85
	1035.020	7/16"	150	50	2	8011578964207	4,10
	1035.030	1/2"	170	76	2	8011578964221	5,00
	1035.040	9/16"	180	80	2	8011578964245	5,10
	1035.050	5/8"	205	114	2	8011578964269	5,45
	1035.070	11/16"	205	130	2	8011578964283	6,20
	1035.080	3/4"	230	164	2	8011578964306	8,70
	1035.100	13/16"	245	200	2	8011578964320	11,15
	1035.110	7/8"	255	234	2	8011578964344	12,40
	1035.120	15/16"	280	302	2	8011578964368	14,85
	1035.130	1"	285	246	2	8011578964382	16,10
	1035.140	1.1/16"	305	404	2	8011578964405	18,55
	1035.150	1.1/8"	315	394	2	8011578964429	21,05
	1035.170	1.1/4"	360	598	2	8011578964443	24,65

1035

SERIE CHIAVI COMBINATE in POLLICI - scatola cartone
SET COMBINATION WRENCHES in INCH - box

Contenuto - content:

1035.005	1035.008	1035.010	1035.020	1035.030
1035.040	1035.050	1035.070	1035.080	

Icona Pz. Barcode €

1035.909 **9** 8011578970369 **45,00**

serie - set
9



Contenuto - content:

1035.005	1035.020	1035.050	1035.100	1035.130
1035.008	1035.030	1035.070	1035.110	
1035.010	1035.040	1035.080	1035.120	

Icona Pz. Barcode €

1035.913 **13** 8011578964481 **99,50**

serie - set
13



1035

SERIE CHIAVI COMBINATE in POLLICI - scatola cartone
SET COMBINATION WRENCHES in INCH - box

Contenuto - content:

1035.005	1035.080
1035.008	1035.100
1035.010	1035.110
1035.020	1035.120
1035.030	1035.130
1035.040	1035.140
1035.050	1035.150
1035.070	1035.170

Icona Pz. Barcode €

1035.916 **16** 8011578964504 **163,70**

serie - set
16

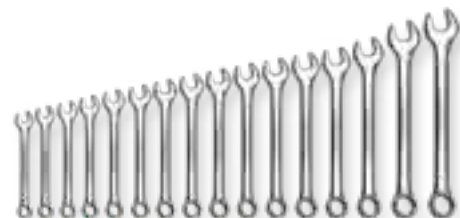

1041
SERIE CHIAVI COMBinate DOPPIA CURVA 75°
SET COMBINATION WRENCHES OFFSET 75°

Contenuto - content:

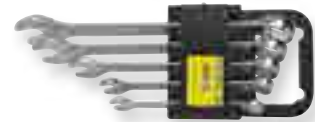
 1040.080 8-8 1040.130 13-13 1040.190 19-19
 1040.100 10-10 1040.170 17-17
serie - set
5
 Pz.   €
1041.905 **5** 525 8011578968984 **30,65**

Contenuto - content:

 1040.080 8-8 1040.110 11-11 1040.140 14-14 1040.170 17-17
 1040.100 10-10 1040.130 13-13 1040.150 15-15 1040.190 19-19
serie - set
8
 Pz.   €
1041.980 **8** 760 8011578969004 **56,90**
**1041**
SERIE 9 CHIAVI COMBinate DOPPIA CURVA 75° - clip in plastica compatta
SET 9 COMBINATION WRENCHES OFFSET 75° - compact plastic clip

 clip in plastica compatta
 compact plastic clip

Contenuto - content:

 1040.080 8-8 1040.140 14-14
 1040.100 10-10 1040.150 15-15
 1040.110 11-11 1040.170 17-17
 1040.120 12-12 1040.190 19-19
 1040.130 13-13
serie - set
9
 Pz.   €
1041.909 **9** 900 8011578970628 **53,85**
**1043**
SERIE 8 CHIAVI COMBinate DOPPIA CURVA 75° - scatola cartone
SET 8 COMBINATION WRENCHES OFFSET 75° - box

Contenuto - content:

 1040.080 8-8 1040.110 11-11 1040.140 14-14 1040.170 17-17
 1040.100 10-10 1040.130 13-13 1040.150 15-15 1040.190 19-19
serie - set
8
 Pz.  €
1043.080 **8** 8011578969028 **45,55**

1048 CHIAVE DOPPIA TORX
 DOUBLE RING TORX WRENCH



Icona	Modello	Lunghezza	Spessore	Quantità	Barcode	Prezzo
	1048.068 E6-E8	112	22	2	8011578964528	2,10
	1048.102 E10-E12	145	38	2	8011578964542	2,65
	1048.148 E14-E18	180	80	2	8011578964566	4,75
	1048.204 E20-E24	220	158	2	8011578964580	8,50

1048 SERIE 4 CHIAVI DOPPIA TORX - scatola
 SET 4 DOUBLE RING TORX WRENCHES - box



Contenuto - content:
 1048.068 1048.148
 1048.102 1048.204

serie - set
4

Icona	Pz.	Spessore	Barcode	Prezzo
	4	300	8011578964603	18,00

1050.015 PANNELLO ESPOSITORE 122 CHIAVI forchetta - combinate - metallo
 DISPLAY 122 double ended WRENCHES - combination - metal



Contenuto - content:

1020.067	6-7	Nr. 6	1030.120	12-12	Nr. 6
1020.089	8-9	Nr. 6	1030.130	13-13	Nr. 6
1020.101	10-11	Nr. 6	1030.140	14-14	Nr. 6
1020.123	12-13	Nr. 6	1030.150	15-15	Nr. 2
1020.145	14-15	Nr. 2	1030.160	16-16	Nr. 2
1020.167	16-17	Nr. 2	1030.170	17-17	Nr. 2
1020.189	18-19	Nr. 2	1030.180	18-18	Nr. 2
1020.202	20-22	Nr. 2	1030.190	19-19	Nr. 2
1020.213	21-23	Nr. 2	1030.200	20-20	Nr. 2
1020.247	24-27	Nr. 2	1030.210	21-21	Nr. 2
1020.258	25-28	Nr. 2	1030.220	22-22	Nr. 2
1020.302	30-32	Nr. 2	1030.230	23-23	Nr. 2
1030.060	6-6	Nr. 6	1030.240	24-24	Nr. 2
1030.070	7-7	Nr. 6	1030.250	25-25	Nr. 2
1030.080	8-8	Nr. 6	1030.270	27-27	Nr. 2
1030.090	9-9	Nr. 6	1030.300	30-30	Nr. 2
1030.100	10-10	Nr. 6	1030.320	32-32	Nr. 2
1030.110	11-11	Nr. 6			

Icona	Lunghezza	Spessore	Barcode	Prezzo
	1050.015 490 x 800	21200	8011578985325	643,10 new
	1050.215 vuoto - empty	5800	8011578985349	40,00 new

1051 CHIAVE PER RACCORDI TUBI - POLIGONALI

FLARE NUT OPEN RING WRENCH - OFFSET



Icona	●	L	Icona	Icona	Barcode	€
1051.080	8-10	140	41	6	8011578935207	8,60
1051.091	9-11	150	58	6	8011578935221	9,60
1051.101	10-11	150	53	6	8011578935245	9,65
1051.113	11-13	168	89	6	8011578935269	10,10
1051.124	12-14	170	103	6	8011578935283	10,20
1051.179	17-19	215	157	6	8011578935306	12,85
1051.192	19-22	220	232	6	8011578935320	16,70
1051.224	22-24	235	251	6	8011578935344	18,95
1051.247	24-27	255	324	6	8011578935368	19,10
1051.302	30-32	275	413	6	8011578935382	40,40

1051C SERIE 10 CHIAVI RACCORDI - scatola

SET 10 FLARE NUT WRENCHES - box

Contenuto - content:

1051.080 8-10
 1051.091 9-11
 1051.101 10-11
 1051.113 11-13
 1051.124 12-14
 1051.179 17-19
 1051.192 19-22
 1051.224 22-24
 1051.247 24-27
 1051.302 30-32

serie - set
10

Icona	Pz.	Icona	Icona	Barcode	€
1051.310	10	1798	6	8011578051303	156,10

1052 CHIAVE PER PONTEGGI

OFFSET DOUBLE RING WRENCH BUILDING



Icona	●	L	Icona	Icona	Barcode	€
1052.212	21-22	335	486	6	8011578935689	13,45

1053 CHIAVE PER PONTEGGI A CRICCHETTO REVERSIBILE

RACHET WRENCH REVERSIBLE FOR BUILDING



Icona	●	L	Icona	Icona	Barcode	€
1053.212	21-22	310	414	2	8011578961084	20,90

1055 CHIAVE COMBINATA A CRICCHETTO SNODATA
COMBINATION FLEX RATCHET WRENCH

Pro
INDUSTRIAL

72 denti - ripresa 5°
72 teeth - 5° action



snodata
flex

Model	Size	Length	Weight	Material	Barcode	Price
1055.080	8-8	145	50	6	8011578935405	11,70
1055.090	9-9	155	68	6	8011578935429	12,30
1055.100	10-10	155	66	6	8011578935443	12,55
1055.110	11-11	165	85	6	8011578935467	12,90
1055.120	12-12	180	117	6	8011578935481	14,30
1055.130	13-13	180	114	6	8011578935504	14,45
1055.140	14-14	190	136	6	8011578935528	16,30
1055.150	15-15	205	155	6	8011578935542	17,85
1055.160	16-16	205	162	6	8011578935566	18,00
1055.170	17-17	222	227	6	8011578935580	19,00
1055.180	18-18	222	213	6	8011578935603	19,20
1055.190	19-19	240	250	6	8011578935627	20,40

1056 SERIE CHIAVI COMBINATE A CRICCHETTO SNODATE - scatola
SET COMBINATION FLEX RATCHET WRENCHES - box

Contenuto - content:

1055.080 8-8	1055.170 17-17
1055.100 10-10	1055.190 19-19
1055.130 13-13	

serie - set
5

Model	Pz.	Weight	Barcode	Price
1056.050	5	747	8011578056308	78,10

Contenuto - content:

1055.080 8-8	1055.140 14-14
1055.100 10-10	1055.170 17-17
1055.110 11-11	1055.190 19-19
1055.120 12-12	
1055.130 13-13	

serie - set
8

Model	Pz.	Weight	Barcode	Price
1056.080	8	1080	8011578056322	121,60

Contenuto - content:

1055.080 8-8	1055.130 13-13	1055.180 18-18
1055.090 9-9	1055.140 14-14	1055.190 19-19
1055.100 10-10	1055.150 15-15	
1055.110 11-11	1055.160 16-16	
1055.120 12-12	1055.170 17-17	

serie - set
12

Model	Pz.	Weight	Barcode	Price
1056.120	12	1674	8011578056339	188,95



1056 SERIE CHIAVI COMBINATE A CRICCHETTO SNODATE
SET COMBINATION FLEX RATCHET WRENCHES

Contenuto - content:

1055.080 8-8	1055.170 17-17
1055.100 10-10	1055.190 19-19
1055.130 13-13	

serie - set
5

Model	Pz.	Weight	Barcode	Price
1056.905	5	808	8011578056346	80,40



1056
SERIE CHIAVI COMBinate A CRICCHETTO SNODATE
SET COMBINATION FLEX RATCHET WRENCHES

 clip in plastica compatta - a libro
 compact plastic clip
Pro
INDUSTRIAL

Contenuto - content:

1055.080	8-8	1055.140	14-14
1055.100	10-10	1055.150	15-15
1055.110	11-11	1055.170	17-17
1055.120	12-12	1055.190	19-19
1055.130	13-13		

serie - set
9

1056.909
Pz.
9

1305



8 011578 000004

€

142,45**Pro**
INDUSTRIAL

Contenuto - content:

1055.080	8-8	1055.140	14-14
1055.090	9-9	1055.150	15-15
1055.100	10-10	1055.160	16-16
1055.110	11-11	1055.170	17-17
1055.120	12-12	1055.190	19-19
1055.130	13-13		

serie - set
11

1056.911
Pz.
11

1758

8 011578 000004

€

180,85**1057**
SERIE CHIAVI COMBinate A CRICCHETTO SNODATE - busta tela avvolgibile
SET COMBINATION FLEX RATCHET WRENCHES - envelope canvas roller blind

Contenuto - content:

1055.080	8-8	1055.130	13-13
1055.100	10-10	1055.140	14-14
1055.110	11-11	1055.170	17-17
1055.120	12-12	1055.190	19-19

serie - set
8

1057.080
Pz.
8

1123

8 011578 000004

€

132,95

Contenuto - content:

1055.080	8-8	1055.140	14-14
1055.090	9-9	1055.150	15-15
1055.100	10-10	1055.160	16-16
1055.110	11-11	1055.170	17-17
1055.120	12-12	1055.180	18-18
1055.130	13-13	1055.190	19-19

serie - set
12

1057.120
Pz.
12

1802

8 011578 000004

€

206,25

1058 CHIAVE COMBINATA A CRICCHETTO REVERSIBILE - tipo STANDARD
 COMBINATION REVERSIBLE RATCHET WRENCH - STANDARD type

Quality
 GARANTIA
 GUARANTEE



reversible
 reversible

72 denti - ripresa 5° - testa inclinata 15°
 72 teeth - 5° action - 15° offset head

Icona	Spessore	Lunghezza	Peso	Imballaggio	Barcode	Prezzo
	8-8	132	36	6	8011578983741	8,80 new
	10-10	152	56	6	8011578983789	9,55 new
	13-13	177	93	6	8011578983826	10,90 new
	17-17	220	180	6	8011578983864	13,65 new
	19-19	240	220	6	8011578983901	14,65 new

1058.9 SERIE 5 CHIAVI COMBINATE A CRICCHETTO REVERSIBILE - tipo STANDARD
 SET 5 COMBINATION REVERSIBLE RATCHET WRENCH - STANDARD type

Contenuto - content:

1058.080	8-8	1058.170	17-17
1058.100	10-10	1058.190	19-19
1058.130	13-13		

serie - set
5



Icona	Pz.	Peso	Barcode	Prezzo
	5	620	8011578983949	59,85 new



1060 CHIAVE COMBINATA A CRICCHETTO REVERSIBILE
 COMBINATION REVERSIBLE RATCHET WRENCH



reversibile
reversible

72 denti - ripresa 5° - testa inclinata 15°
 72 teeth - 5° action - 15° offset head

Model	Size	Length	Weight	Material	Barcode	Price
1060.080	8-8	140	42	6	8011578935702	12,45
1060.090	9-9	150	46	6	8011578935726	13,10
1060.100	10-10	160	66	6	8011578935740	13,30
1060.110	11-11	160	66	6	8011578935764	13,70
1060.120	12-12	170	84	6	8011578935788	15,20
1060.130	13-13	177	106	6	8011578935801	15,35
1060.140	14-14	185	126	6	8011578935825	17,35
1060.150	15-15	197	130	6	8011578935849	19,00
1060.160	16-16	210	150	6	8011578935863	19,10
1060.170	17-17	220	193	6	8011578935887	20,15
1060.180	18-18	230	216	6	8011578935900	21,60
1060.190	19-19	240	242	6	8011578935924	22,00
1060.220	22-22	280	378	6	8011578965785	31,45
1060.240	24-24	310	500	6	8011578965808	36,70

1061 SERIE CHIAVI COMBINATE A CRICCHETTO REVERSIBILE - scatola cartone
 SET COMBINATION REVERSIBLE RATCHET WRENCHES - box

Contenuto - content:

- 1060.080 8-8
- 1060.100 10-10
- 1060.110 11-11
- 1060.120 12-12
- 1060.130 13-13
- 1060.140 14-14
- 1060.170 17-17
- 1060.190 19-19

serie - set
8



Model	Pz.	Weight	Barcode	Price
1061.080	8	962	8011578061081	129,50

Contenuto - content:

- 1060.080 8-8
- 1060.090 9-9
- 1060.100 10-10
- 1060.110 11-11
- 1060.120 12-12
- 1060.130 13-13
- 1060.140 14-14
- 1060.150 15-15
- 1060.160 16-16
- 1060.170 17-17
- 1060.180 18-18
- 1060.190 19-19

serie - set
12



Model	Pz.	Weight	Barcode	Price
1061.120	12	1498	8011578061128	202,30

1061 SERIE CHIAVI COMBINATE A CRICCHETTO REVERSIBILE
 SET COMBINATION REVERSIBLE RATCHET WRENCHES

Contenuto - content:

- 1060.080 8-8
- 1060.100 10-10
- 1060.130 13-13
- 1060.170 17-17
- 1060.190 19-19

serie - set
5



Model	Pz.	Weight	Barcode	Price
1061.905	5	692	8011578969042	85,55



1061

SERIE CHIAVI COMBinate A CRICCHETTO REVERSIBILE
SET COMBINATION REVERSIBLE RATCHET WRENCHES



clip in plastica compatta - a libro
 compact plastic clip



Pro
INDUSTRIAL

Contenuto - content:

1060.080 8-8	1060.140 14-14
1060.100 10-10	1060.150 15-15
1060.110 11-11	1060.170 17-17
1060.120 12-12	1060.190 19-19
1060.130 13-13	

serie - set
9

 **1061.909**

Pz.
9

 **1085**

80115781000004

€

151,50

Pro
INDUSTRIAL

Contenuto - content:

1060.080 8-8	1060.140 14-14
1060.090 9-9	1060.150 15-15
1060.100 10-10	1060.160 16-16
1060.110 11-11	1060.170 17-17
1060.120 12-12	1060.190 19-19
1060.130 13-13	

serie - set
11

 **1061.911**

Pz.
11

 **1548**

8011578969066

€

193,40



1062

SERIE CHIAVI COMBinate A CRICCHETTO REVERSIBILE - busta tela avvolgibile
SET COMBINATION REVERSIBLE RATCHET WRENCHES - envelope canvas roller blind

Pro
INDUSTRIAL

Contenuto - content:

1060.080 8-8	1060.130 13-13
1060.100 10-10	1060.140 14-14
1060.110 11-11	1060.170 17-17
1060.120 12-12	1060.190 19-19

serie - set
8

 **1062.080**

Pz.
8

 **983**

8011578062088

€

140,85



serie - set
12

Pro
INDUSTRIAL

Contenuto - content:

1060.080 8-8	1060.140 14-14
1060.090 9-9	1060.150 15-15
1060.100 10-10	1060.160 16-16
1060.110 11-11	1060.170 17-17
1060.120 12-12	1060.180 18-18
1060.130 13-13	1060.190 19-19

 **1062.120**

Pz.
12

 **1585**

8011578062125

€

219,60



1063

SERIE CHIAVI COMBinate A CRICCHETTO REVERSIBILE - scatola cartone SET COMBINATION REVERSIBLE RATCHET WRENCHES - box

Contenuto - content:

1060.080 8-8	1060.130 13-13
1060.100 10-10	1060.140 14-14
1060.110 11-11	1060.170 17-17
1060.120 12-12	1060.190 19-19

	Pz.			€
1063.080	8	1028	8011578063085	133,45

serie - set
8



Contenuto - content:

1060.080 8-8	1060.140 14-14
1060.090 9-9	1060.150 15-15
1060.100 10-10	1060.160 16-16
1060.110 11-11	1060.170 17-17
1060.120 12-12	1060.180 18-18
1060.130 13-13	1060.190 19-19

	Pz.			€
1063.120	12	1674	8011578063122	206,70

serie - set
12



1064

ESPOSITORE 45 CHIAVI COMBinate A CRICCHETTO REVERSIBILE - SNODATE - SEMPLICI DISPLAY 45 COMBINATION - REVERSIBLE - FLEX - SIMPLE RATCHET WRENCHES

Contenuto - content:





1055.080 8	Nr. 2	1060.130 13	Nr. 2	1065.130 13	Nr. 2
1055.100 10	Nr. 2	1060.140 14	Nr. 2	1067.080 8	Nr. 2
1055.130 13	Nr. 2	1060.150 15	Nr. 2	1067.100 10	Nr. 2
1055.170 17	Nr. 1	1060.160 16	Nr. 2	1067.130 13	Nr. 2
1055.190 19	Nr. 1	1060.170 17	Nr. 1	1067.170 17	Nr. 1
1060.080 8	Nr. 2	1060.190 19	Nr. 1	1067.190 19	Nr. 1
1060.090 9	Nr. 2	1060.220 22	Nr. 1		
1060.100 10	Nr. 2	1060.240 24	Nr. 1		
1060.110 11	Nr. 2	1065.080 8	Nr. 2		
1060.120 12	Nr. 2	1065.100 10	Nr. 2		

	L x l			€
1064.015	490 x 400	5200	8011578985363	623,90 new
1064.215	vuoto - empty	1000	8011578985387	55,00 new



1065

CHIAVE COMBINATA A CRICCHETTO SEMPLICE - CORTA COMBINATION RATCHET WRENCH - STUBBY

		L x l				€
1065.080	8	90	32	2	8011578967383	6,40
1065.100	10	95	42	2	8011578967406	7,40
1065.130	13	107	82	2	8011578967420	8,10
1065.170	17	126	152	2	8011578967444	10,55
1065.190	19	136	170	2	8011578967468	12,20



1065

SERIE 5 CHIAVI COMBinate A CRICCHETTO SEMPLICE - CORTA SET 5 COMBINATION RATCHET WRENCHES - STUBBY

Contenuto - content:

1065.080 8-8
1065.100 10-10
1065.130 13-13
1065.170 17-17
1065.190 19-19

	Pz.			€
1065.905	5	552	8011578969080	44,65



1067 CHIAVE COMBINATA A CRICCHETTO SEMPLICE
 COMBINATION RATCHET WRENCH

Pro
 INDUSTRIAL

72 denti - ripresa 5°
 72 teeth - 5° action



Icona	Dimensione	Lunghezza	Peso	Imballaggio	Barcode	Prezzo
	8-8	135	40	6	8011578963187	7,40
	10-10	153	64	6	8011578963200	8,00
	13-13	178	100	6	8011578963224	9,05
	17-17	222	196	6	8011578963248	12,90
	19-19	240	246	6	8011578963262	14,10

1068 SERIE 5 CHIAVI COMBINATE A CRICCHETTO SEMPLICE - scatola
 SET 5 COMBINATION RATCHET WRENCHES - box

Contenuto - content:
 1067.080 8-8
 1067.100 10-10
 1067.130 13-13
 1067.170 17-17
 1067.190 19-19

serie - set
5



Icona	Pz.	Peso	Barcode	Prezzo
	5	692	8011578067014	51,45

1068 SERIE 5 CHIAVI COMBINATE A CRICCHETTO SEMPLICE
 SET 5 COMBINATION RATCHET WRENCHES

Contenuto - content:
 1067.080 8-8 1067.170 17-17
 1067.100 10-10 1067.190 19-19
 1067.130 13-13

serie - set
5



Icona	Pz.	Peso	Barcode	Prezzo
	5	716	8011578067007	53,75

1069 ADATTATORE PER CHIAVI A CRICCHETTO
 ADAPTER FOR RATCHET WRENCHES

Icona	Dimensione	per chiave for wrench	Peso	Imballaggio	Barcode	Prezzo
	1/4"	mm. 10	8	6	8011578944247	5,10
	3/8"	mm. 13	18	6	8011578944261	6,00
	1/2"	mm. 19	48	6	8011578944285	7,10

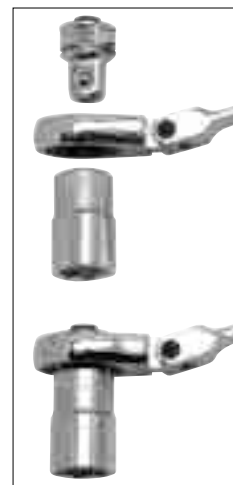

Icona	Dimensione	per chiave for wrench	Peso	Imballaggio	Barcode	Prezzo
	1/4"	mm. 10	8	6	8011578944308	4,65



Icona	Dimensione	per chiave for wrench	Peso	Imballaggio	Barcode	Prezzo
	set 4 adattatori - adapters	mm. 10	88	1	8011578944322	22,85



1070
CHIAVE REGOLABILE - acciaio chrom-vanadium finitura cromata - impugnatura plasticata
ADJUSTABLE WRENCH - chrom-vanadium steel chrome plated finish - plastic handle
Pro
 INDUSTRIAL

DIN 3117 ISO 6787

📄	┌─┐	┆	👤	📦	8115781100004	€
1070.015	150	19	152	2	8011578927073	10,65
1070.020	200	24	274	2	8011578927103	13,35
1070.025	250	30	450	2	8011578927134	19,75
1070.030	300	34	756	2	8011578927165	24,60
1070.037	375	44	1360	1	8011578943189	53,25
1070.045	450	55	1980	1	8011578943202	84,45

1071
CHIAVE REGOLABILE ERGONOMICA - acciaio chrom-vanadium finitura cromata
ADJUSTABLE WRENCH ERGONOMIC - chrom-vanadium steel chrome plated finish
Pro
 INDUSTRIAL

📄	┌─┐	┆	👤	📦	8115781100004	€
1071.015	150	24	160	2	8011578973506	12,70
1071.020	200	29	285	2	8011578973520	14,85
1071.025	250	34	480	2	8011578973544	22,25
1071.030	300	40	800	2	8011578973568	27,55

1074
CHIAVI POLIGONALI CURVE PESANTI - acciaio chrom-vanadium finitura cromata
HEAVY-DUTY OFFSET RING WRENCHES - chrom-vanadium steel chrome plated finish







📄	◆	┌─┐	👤	📦	8115781100004	€
1074.024	24	182	462	1	8011578961107	28,40
1074.027	27	192	518	1	8011578961121	32,85
1074.030	30	202	590	1	8011578961145	37,65
1074.032	32	237	832	1	8011578961169	43,85
1074.036	36	247	910	1	8011578961183	52,80
1074.041	41	267	1062	1	8011578961206	62,75
1074.046	46	282	1434	1	8011578961220	73,55
1074.050	50	292	1450	1	8011578961244	81,95
1074.055	55	302	1650	1	8011578961268	117,85
1074.060	60	347	2700	1	8011578961282	155,45
1074.065	65	357	3100	1	8011578961305	190,05
1074.070	70	365	3400	1	8011578961329	206,35

**1074Z**
IMPUGNATURA TUBO per chiavi poligonali curve pesanti (per chiave 1074)
PIPE for heavy-duty offset ring wrench (for wrench 1074)

📄	∅	┌─┐	👤	📦	8115781100004	€
1074.946	19	460 x mm 24/27/30	760	1	8011578961367	39,05
1074.961	22	610 x mm 32/36/41	1128	1	8011578961381	54,95
1074.976	25	760 x mm 46/50/55	1550	1	8011578961404	95,25
1074.986	30	860 x mm 60/65/70	2500	1	8011578961428	112,35

1075 CHIAVE A PERCUSSIONE A FORCHETTA
 OPEN STRICKEN WRENCH







DIN 133

							€
1075.024	24	160	15	280	1	8011578941161	13,00
1075.027	27	180	15	350	1	8011578941444	15,10
1075.030	30	190	16	542	1	8011578941468	15,80
1075.032	32	196	17	770	1	8011578941482	21,30
1075.036	36	210	18	900	1	8011578941505	27,20
1075.041	41	225	19	1065	1	8011578941529	31,40
1075.046	46	251	20	1114	1	8011578941543	40,10
1075.050	50	275	20	1650	1	8011578941567	53,00
1075.055	55	304	23	2200	1	8011578941581	69,00
1075.060	60	320	24	2600	1	8011578941604	89,00
1075.065	65	340	28	2700	1	8011578941628	122,00
1075.070	70	365	30	4000	1	8011578941642	130,00
1075.075	75	278	30	5000	1	8011578960322	149,45
1075.080	80	400	37	5700	1	8011578941666	286,50
1075.085	85	400	37	6000	1	8011578960346	292,15
1075.090	90	445	38	8500	1	8011578941680	405,00
1075.095	95	445	39	9800	1	8011578941703	418,00
1075.100	100	485	42	12200	1	8011578941727	443,00



1076 CHIAVE A PERCUSSIONE POLIGONALE
 RING STRICKEN WRENCH

DIN 7444

							€
1076.024	24	167	14	296	1	8011578941741	13,90
1076.027	27	179	16	303	1	8011578941765	14,00
1076.030	30	191	17	383	1	8011578941789	15,00
1076.032	32	197	17	474	1	8011578941802	15,85
1076.036	36	206	19	522	1	8011578941826	18,50
1076.041	41	231	22	758	1	8011578941840	24,00
1076.046	46	241	22	853	1	8011578941864	27,00
1076.050	50	255	24	1134	1	8011578941888	37,20
1076.055	55	271	25	1560	1	8011578941901	51,00
1076.060	60	279	25	1500	1	8011578941925	60,50
1076.065	65	295	28	2100	1	8011578941949	83,00
1076.070	70	323	33	3100	1	8011578941963	107,00
1076.075	75	330	34	3100	1	8011578960360	115,75
1076.080	80	361	37	3200	1	8011578941987	159,00
1076.085	85	361	37	4000	1	8011578960384	190,80
1076.090	90	390	40	6000	1	8011578942007	222,60
1076.095	95	390	40	6700	1	8011578942021	250,00
1076.100	100	400	40	7400	1	8011578942045	260,00
1076.105	105	435	46	9000	1	8011578973582	349,00
1076.110	110	435	46	8800	1	8011578973605	365,70
1076.115	115	435	46	8550	1	8011578973629	379,50
1076.120	120	480	51	11600	1	8011578973643	486,55
1076.125	125	480	51	11300	1	8011578973667	487,60
1076.130	130	510	57	13700	1	8011578973681	625,40
1076.135	135	510	59	13500	1	8011578973704	690,00
1076.140	140	510	61	13200	1	8011578973728	759,00



1077 CHIAVE GAS
 WRENCH GAS

						€
1077.025	25	135	106	12	8011578961442	2,10



1078 CHIAVE DUE BOCCHE DIN 895 - finitura zincata

WRENCH DOUBLE OPEN DIN 895 - zinc finish



DIN 895

Icona	Sp.†	L	Sp.†	Pz.	Barcode	€
	6x7	96	3,4	16	10 8011578961466	0,75
	7x8	107	3,5	18	10 8011578961480	0,85
	8x9	110	3,8	24	10 8011578963040	1,05
	8x10	115	4,3	28	10 8011578961503	1,05
	10x11	118	5,0	32	10 8011578961527	1,10
	10x13	122	5,0	36	10 8011578961541	1,05
	12x13	142	5,3	42	10 8011578961565	1,10
	13x17	155	6,4	78	10 8011578961589	1,40
	14x15	145	5,8	60	10 8011578970666	1,80
	16x17	155	6,2	71	10 8011578970680	1,90
	17x19	170	6,5	104	10 8011578961602	2,05
	17x22	198	7,8	144	10 8011578961626	2,55
	18x19	170	6,7	77	10 8011578970703	2,30
	19x22	198	7,8	154	10 8011578961640	2,55
	19x24	207	8,5	168	5 8011578961664	3,10
	20x22	198	7,8	170	5 8011578961688	3,15
	22x24	218	9,0	170	5 8011578961701	3,60
	24x27	240	9,8	236	5 8011578961725	4,70
	24x30	265	11,0	400	5 8011578964627	5,35
	27x30	270	10,8	420	5 8011578964641	5,55
	30x32	275	11,5	436	5 8011578961749	6,65
	36x41	340	14,0	755	5 8011578969745	12,30
	41x46	385	15,2	1034	5 8011578973742	19,90
	46x50	420	17,0	1245	4 8011578973766	25,00
	50x55	465	18,8	1750	4 8011578973780	37,70
	55x60	500	18,8	1860	2 8011578973803	42,95

1078.8 CHIAVE A FORCHETTA tipo STANDARD - acciaio chrom-vanadium finitura cromata

DOUBLE ENDED OPEN WRENCH - STANDARD type - chrom-vanadium steel chrome plated finish

DIN 3110 ISO 10102



Icona	Sp.†	L	Pz.	Barcode	€
	8x9	140	33	10 8011578977009	1,20 new
	10x11	160	48	10 8011578977023	1,50 new
	12x13	172	65	10 8011578977047	1,70 new

1078.9 SERIE CHIAVI A FORCHETTA tipo STANDARD - plastica

SET DOUBLE ENDED OPEN WRENCHES - STANDARD type - plastic

DIN 3110

Contenuto - content:

1078.867 6-7	1078.814 14-15
1078.889 8-9	1078.816 16-17
1078.810 10-11	1078.818 18-19
1078.812 12-13	1078.820 20-22

serie-set
8

Icona	Pz.	Barcode	€
	8	10 8011578977160	16,75 new

DIN 3110

Contenuto - content:

1078.867 6-7	1078.816 16-17	1078.825 25-28
1078.889 8-9	1078.818 18-19	1078.830 30-32
1078.810 10-11	1078.820 20-22	
1078.812 12-13	1078.821 21-23	
1078.814 14-15	1078.824 24-27	

serie-set
12







Icona	Pz.	Barcode	€
	12	10 8011578977184	41,25 new

1079

CHIAVE UNA BOCCA DIN 894 - finitura zincata
WRENCH SINGLE OPEN DIN 894 - zinc finish



DIN 894

								
1079.006	6	75	3,5	11	10	8011578961763	0,90	
1079.007	7	75	3,5	12	10	8011578961787	0,90	
1079.008	8	95	4,0	12	10	8011578961800	0,90	
1079.009	9	105	4,5	22	10	8011578961824	0,95	
1079.010	10	105	4,5	18	10	8011578961848	0,95	
1079.011	11	111	5,0	23	10	8011578970741	1,00	
1079.012	12	125	5,0	20	10	8011578965761	1,00	
1079.013	13	125	5,5	38	10	8011578961862	1,05	
1079.015	15	140	5,5	40	10	8011578969769	1,30	
1079.017	17	160	6,0	70	10	8011578961886	1,50	
1079.019	19	170	6,5	78	10	8011578961909	1,65	
1079.022	22	195	8,0	106	5	8011578961923	2,40	
1079.023	23	195	8,0	125	5	8011578971984	2,40	
1079.024	24	215	8,5	132	5	8011578961947	2,85	
1079.027	27	240	10,0	218	5	8011578961961	3,70	
1079.030	30	260	10,0	254	5	8011578961985	4,55	
1079.032	32	275	12,0	288	5	8011578962005	5,55	
1079.034	34	275	12,0	300	5	8011578963507	6,40	
1079.036	36	300	13,0	410	5	8011578962029	7,75	
1079.038	38	305	13,0	437	5	8011578965860	7,80	
1079.041	41	340	14,0	534	5	8011578962043	13,50	
1079.042	42	345	14,0	581	5	8011578969783	13,70	
1079.046	46	375	15,5	782	5	8011578962067	16,20	
1079.050	50	405	15,5	1200	5	8011578962081	19,20	
1079.055	55	450	17,0	1352	5	8011578962104	23,20	
1079.060	60	475	18,0	1756	4	8011578962128	35,60	
1079.065	65	515	18,0	1600	4	8011578962142	43,50	
1079.070	70	560	20,0	2000	2	8011578963064	73,00	
1079.075	75	nere-black	600	20,0	2990	2	8011578969806	88,00
1079.080	80	nere-black	670	22,5	4140	2	8011578969820	103,00
1079.085	85	nere-black	680	22,5	3980	1	8011578969844	123,00
1079.090	90	nere-black	680	22,5	3700	1	8011578969868	129,00
1079.095	95	nere-black	847	26,0	5800	1	8011578969882	194,00
1079.100	100	nere-black	847	26,0	5500	1	8011578969905	260,00
1079.105	105	nere-black	1000	26,0	7450	1	8011578969929	283,00
1079.110	110	nere-black	1000	29,0	7400	1	8011578973827	348,00
1079.115	115	nere-black	1000	29,0	7300	1	8011578973841	385,85
1079.120	120	nere-black	1000	29,0	7250	1	8011578973865	442,00
1079.125	125	nere-black	1000	29,0	7200	1	8011578973889	469,00
1079.130	130	nere-black	1000	29,0	7150	1	8011578973902	497,00
1079.135	135	nere-black	1000	29,0	7100	1	8011578973926	524,70

1079.8
CHIAVE COMBINATA tipo STANDARD - acciaio chrom-vanadium finitura cromata teste lucide
COMBINATION WRENCH - STANDARD type - chrom-vanadium steel chrome plated finish polish heads

DIN 3113

Icona	●	L	h	Icona	8011578	€
	1079.808	8	125	32	10 8011578977061	0,90 new
	1079.810	10	142	42	8011578977085	1,05 new
	1079.813	13	174	82	8011578977108	1,35 new
	1079.817	17	210	136	8011578977122	1,90 new
	1079.819	19	235	182	8011578977146	2,45 new

1079.9
SERIE CHIAVI COMBINATE tipo STANDARD - scatola cartone
SET COMBINATION WRENCHES - STANDARD type - box

DIN 3113

Contenuto - content:

1079.980	8-8	1079.913	13-13
1079.990	9-9	1079.914	14-14
1079.910	10-10	1079.917	17-17
1079.911	11-11	1079.919	19-19

Icona	Pz.	Icona	8011578	€
	1079.908	8	651 8011578980009	11,60 new

DIN 3113

Contenuto - content:

1079.960	6-6	1079.912	12-12
1079.970	7-7	1079.913	13-13
1079.980	8-8	1079.914	14-14
1079.990	9-9	1079.917	17-17
1079.910	10-10	1079.919	19-19
1079.911	11-11	1079.922	22-22

Icona	Pz.	Icona	8011578	€
	1079.912	12	1006 8011578980023	17,90 new

1079.9
SERIE CHIAVI COMBINATE tipo STANDARD - busta tela avvolgibile
SET COMBINATION WRENCHES - STANDARD type - envelope canvas roller blind

DIN 3113

Contenuto - content:

1079.960	6-6	1079.919	19-19
1079.970	7-7	1079.920	20-20
1079.980	8-8	1079.921	21-21
1079.990	9-9	1079.922	22-22
1079.910	10-10	1079.923	23-23
1079.911	11-11	1079.924	24-24
1079.912	12-12	1079.925	25-25
1079.913	13-13	1079.926	26-26
1079.914	14-14	1079.927	27-27
1079.915	15-15	1079.928	28-28
1079.916	16-16	1079.930	30-30
1079.917	17-17	1079.932	32-32
1079.918	18-18		

Icona	Pz.	Icona	8011578	€
	1079.925	25	5000 8011578977245	91,80 new



1080 CHIAVE A TUBO DOPPIA - FERRO tipo leggero - tipo STANDARD - finitura zincata
TUBULAR WRENCH - IRON light type - STANDARD type - zinc finish

Icona	Ø	L	foro-hole	Icona	Icona	Barcode	€	DIN 896
	6-7	95	5	35	6	8011578927196	1,65	
	8-9	95	5	38	6	8011578927226	1,80	
	10-11	105	5	45	6	8011578927257	1,85	
	12-13	110	6,5	52	6	8011578927288	2,05	
	14-15	115	8	72	6	8011578927318	2,20	
	16-17	115	8	80	6	8011578927349	2,25	
	18-19	130	8	96	6	8011578927370	2,40	
	20-22	135	8	153	6	8011578927400	2,80	
	24-26	145	10	190	6	8011578927431	3,10	
	25-28	160	10	215	6	8011578927462	3,60	
	30-32	165	12	267	6	8011578927493	4,15	
	55-55	200	12	577	2	8011578927523	7,90	



1081 SERIE CHIAVI A TUBO - FERRO tipo leggero - scatola
SET TUBULAR WRENCHES - IRON light type - box

Contenuto - content:

1080.067 6-7	1080.123 12-13	
1080.089 8-9	1080.145 14-15	
1080.101 10-11	1080.167 16-17	

Icona	Pz.	Icona	Barcode	€
	6	348	8011578081003	11,80

Contenuto - content:

1080.067 6-7	1080.145 14-15	
1080.089 8-9	1080.167 16-17	
1080.101 10-11	1080.189 18-19	
1080.123 12-13	1080.202 20-22	

Icona	Pz.	Icona	Barcode	€
	8	608	8011578081027	17,00

Contenuto - content:

1080.067 6-7	1080.189 18-19	
1080.089 8-9	1080.202 20-22	
1080.101 10-11	1080.246 24-26	
1080.123 12-13	1080.258 25-28	
1080.145 14-15	1080.302 30-32	
1080.167 16-17		

Icona	Pz.	Icona	Barcode	€
	11	1270	8011578081041	27,85



1090 CHIAVE A PIPA DOPPIA - FERRO tipo leggero - tipo STANDARD - finitura zincata
OFFSET TUBULAR WRENCHES - IRON light type - STANDARD type - zinc finish

Icona	Ø	L	Icona	Icona	Barcode	€
	6-6	85 30	28	6	8011578927554	2,50
	7-7	85 30	32	6	8011578927585	2,50
	8-8	90 30	68	6	8011578927615	2,60
	10-10	95 35	58	6	8011578927677	2,90
	12-12	100 40	102	6	8011578927738	3,40
	13-13	110 50	100	6	8011578927769	3,95
	14-14	110 50	110	6	8011578927790	3,95
	15-15	110 50	130	6	8011578927820	4,30
	16-16	120 50	128	6	8011578927851	4,30
	17-17	120 55	138	6	8011578927882	4,90
	19-19	130 60	132	6	8011578927943	4,95
	20-20	135 70	205	6	8011578927974	5,10
	22-22	145 70	194	6	8011578928032	5,60



1092
CHIAVE A TUBO DOPPIA PROFESSIONALE - acciaio chrom vanadium
DOUBLE TUBULAR WRENCHES - PROFESSIONAL - chrom vanadium steel
Pro
 INDUSTRIAL

DIN 896

Icona	●	←-L-→	foro-hole	Icona	Icona	Barcode	€
1092.067	6-7	110	7	38	6	8011578935948	2,30
1092.089	8-9	110	7	42	6	8011578935962	2,45
1092.101	10-11	122	7	72	6	8011578935986	2,95
1092.123	12-13	140	9	93	6	8011578936006	3,50
1092.145	14-15	140	9	95	6	8011578936020	3,75
1092.167	16-17	152	10,5	124	6	8011578936044	4,20
1092.189	18-19	162	13	172	6	8011578936068	5,35
1092.202	20-22	172	13	253	6	8011578936082	6,60
1092.213	21-23	172	15	222	2	8011578936105	7,25
1092.246	24-26	195	15	407	2	8011578936129	9,20
1092.258	25-28	192	16	394	2	8011578936143	10,65
1092.279	27-29	200	16	414	2	8011578936167	10,95
1092.302	30-32	205	17	450	2	8011578936181	11,20

1093
SERIE CHIAVI TUBO DOPPIE - scatola cartone
SET DOUBLE TUBULAR WRENCHES - box
Pro
 INDUSTRIAL

Contenuto - content:

1092.067	6-7	1092.145	14-15
1092.089	8-9	1092.167	16-17
1092.101	10-11	1092.189	18-19
1092.123	12-13	1092.202	20-22

Icona	Pz.	Icona	Barcode	€
1093.080	8	917	8011578093105	31,10

 serie - set
8

Pro
 INDUSTRIAL

Contenuto - content:

1092.067	6-7	1092.189	18-19
1092.089	8-9	1092.202	20-22
1092.101	10-11	1092.213	21-23
1092.123	12-13	1092.246	24-26
1092.145	14-15	1092.258	25-28
1092.167	16-17	1092.302	30-32

Icona	Pz.	Icona	Barcode	€
1093.120	12	2500	8011578093150	69,40

 serie - set
12
**1093A**
SERIE CHIAVI TUBO DOPPIE - busta tela avvolgibile
SET DOUBLE TUBULAR WRENCHES - envelope canvas roller blind
Pro
 INDUSTRIAL

Contenuto - content:

1092.067	6-7	1092.145	14-15
1092.089	8-9	1092.167	16-17
1092.101	10-11	1092.189	18-19
1092.123	12-13	1092.202	20-22

Icona	Pz.	Icona	Barcode	€
1093.180	8	942	8011578093006	42,45

 serie - set
8

1096 CHIAVE A TUBO DOPPIA PESANTE CR-VA
 DOUBLE ENDED HEAVY TUBULAR WRENCH



Icona	Ø	L	foro-hole	Peso	Imballaggio	Barcode	Prezzo
	6-7	105	3,5	41	6	8011578936204	11,00
	8-9	110	4,0	54	6	8011578936228	11,95
	10-11	120	5,5	75	6	8011578936242	12,40
	12-13	135	5,5	102	6	8011578936266	14,50
	14-15	145	5,5	150	6	8011578936280	17,45
	16-17	155	8,0	184	6	8011578936303	18,85
	18-19	165	9,0	266	6	8011578936327	23,55
	20-22	175	10,0	322	6	8011578936341	24,95

1097 SERIE CHIAVI TUBO PESANTI - scatola cartone
 SET ENDED HEAVY TUBULAR WRENCHES - box

Contenuto - content:
 1096.067 6-7
 1096.089 8-9
 1096.101 10-11
 1096.123 12-13
 1096.145 14-15
 1096.167 16-17
 1096.189 18-19
 1096.202 20-22

serie - set
8



Icona	Pz.	Peso	Barcode	Prezzo
	8	1214	8011578097202	134,65

1097A SERIE CHIAVI TUBO PESANTI - busta tela avvolgibile
 SET ENDED HEAVY TUBULAR WRENCHES - envelope canvas roller blind

Contenuto - content:
 1096.067 6-7
 1096.089 8-9
 1096.101 10-11
 1096.123 12-13
 1096.145 14-15
 1096.167 16-17
 1096.189 18-19
 1096.202 20-22

serie - set
8



Icona	Pz.	Peso	Barcode	Prezzo
	8	1264	8011578097059	146,00





1097Z SPINA DI MANOVRA PER CHIAVI A TUBO
 DRIVE BAR



Icona	Ø	Peso	Imballaggio	Barcode	Prezzo
	5 x 8 x 10	102	6	8011578938987	6,15
	12	120	6	8011578969103	3,95
	14	130	6	8011578969127	4,50
	19	150	6	8011578969943	10,10

1098 CHIAVE A PIPA PASSANTE DOPPIA - ESAGONO - POLIGONALE
 ANGLE OPEN SOCKETS WRENCH - HEXAGON - BIHEXAGON



		L	L				€
1098.060	6-6	108	33	77	6	8011578936464	6,75
1098.070	7-7	110	36	73	6	8011578936488	6,75
1098.080	8-8	113	34	89	6	8011578936501	6,75
1098.090	9-9	122	35	86	6	8011578936525	6,75
1098.100	10-10	131	40	114	6	8011578936549	7,00
1098.110	11-11	138	40	125	6	8011578936563	7,85
1098.120	12-12	145	42	164	6	8011578936587	8,45
1098.130	13-13	162	44	192	6	8011578936600	9,15
1098.140	14-14	170	46	204	6	8011578936624	10,15
1098.150	15-15	180	48	217	6	8011578936648	12,40
1098.160	16-16	185	52	244	6	8011578936662	13,70
1098.170	17-17	190	52	306	6	8011578936686	14,35
1098.180	18-18	200	59	356	6	8011578936709	14,80
1098.190	19-19	210	59	442	6	8011578936723	16,05
1098.200	20-20	220	65	482	2	8011578936747	19,30
1098.210	21-21	222	68	575	2	8011578936761	20,20
1098.220	22-22	230	68	548	2	8011578936785	20,25
1098.230	23-23	245	75	678	2	8011578936808	26,20
1098.240	24-24	250	80	782	2	8011578936822	26,25
1098.270	27-27	285	90	975	2	8011578936846	33,60
1098.300	30-30	320	100	1352	2	8011578936860	40,90
1098.320	32-32	355	105	1526	2	8011578936884	40,90

1099 SERIE CHIAVI PIPA DOPPIE - scatola cartone
 SET ANGLE OPEN SOCKETS WRENCHES - box

Contenuto - content:

1098.080	8-8	1098.130	13-13
1098.090	9-9	1098.140	14-14
1098.100	10-10	1098.170	17-17
1098.110	11-11	1098.190	19-19

	Pz.			€
1099.080	8	1636	8011578099305	78,05

serie - set
8



Contenuto - content:

1098.060	6-6	1098.100	10-10	1098.140	14-14
1098.070	7-7	1098.110	11-11	1098.170	17-17
1098.080	8-8	1098.120	12-12	1098.190	19-19
1098.090	9-9	1098.130	13-13	1098.220	22-22

	Pz.			€
1099.120	12	2600	8011578099350	120,25

serie - set
12



Contenuto - content:

1098.060	6-6	1098.120	12-12	1098.180	18-18
1098.070	7-7	1098.130	13-13	1098.190	19-19
1098.080	8-8	1098.140	14-14	1098.200	20-20
1098.090	9-9	1098.150	15-15	1098.210	21-21
1098.100	10-10	1098.160	16-16	1098.220	22-22
1098.110	11-11	1098.170	17-17		

	Pz.			€
1099.170	17	4400	8011578099404	200,65

serie - set
17





1099

SERIE CHIAVI PIPA DOPPIE - scatola cartone
 SET ANGLE OPEN SOCKETS WRENCHES - box

Contenuto - content:

1098.060 6-6	1098.140 14-14	1098.220 22-22
1098.070 7-7	1098.150 15-15	1098.230 23-23
1098.080 8-8	1098.160 16-16	1098.240 24-24
1098.090 9-9	1098.170 17-17	1098.270 27-27
1098.100 10-10	1098.180 18-18	1098.300 30-30
1098.110 11-11	1098.190 19-19	1098.320 32-32
1098.120 12-12	1098.200 20-20	
1098.130 13-13	1098.210 21-21	

serie - set
22

 **1099.220** Pz. **22**  **9600**  **8011578099459** € **368,50**



1099A

SERIE CHIAVI PIPA DOPPIE - busta tela avvolgibile
 SET ANGLE OPEN SOCKETS WRENCHES - envelope canvas roller blind

Contenuto - content:

1098.080 8-8
1098.090 9-9
1098.100 10-10
1098.110 11-11
1098.130 13-13
1098.140 14-14
1098.170 17-17
1098.190 19-19

serie - set
8

 **1099.980** Pz. **8**  **1600**  **8011578099473** € **89,40**







1100.015

ESPOSITORE 58 CHIAVI TUBO E PIPA
 DISPLAY 58 TUBULAR AND ANGLE WRENCHES

Contenuto - content:

1092.067 6X7	Nr. 2
1092.089 8X9	Nr. 2
1092.101 10X11	Nr. 2
1092.123 12X13	Nr. 2
1092.145 14X15	Nr. 2
1092.167 16X17	Nr. 2
1092.189 18X19	Nr. 2
1092.202 20X22	Nr. 2
1092.213 21X23	Nr. 2
1092.246 24X26	Nr. 2
1092.258 25X28	Nr. 2
1092.279 27X29	Nr. 2
1092.302 30X32	Nr. 2
1096.067 6X7	Nr. 2
1096.089 8X9	Nr. 2
1096.101 10X11	Nr. 2
1096.123 12x13	Nr. 2
1096.145 14x15	Nr. 2
1096.167 16x17	Nr. 2
1096.189 18x19	Nr. 2
1096.202 20x22	Nr. 2
1098.060 6	Nr. 2
1098.080 8	Nr. 2
1098.100 10	Nr. 2
1098.130 13	Nr. 2
1098.150 15	Nr. 2
1098.170 17	Nr. 2
1098.190 19	Nr. 2
1098.220 22	Nr. 2

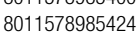

 **1100.015**  **490 x 400**  **26300**  **8011578985400** € **615,40 new**

1100.215 vuoto - empty **4400**  **8011578985424** € **55,00 new**



0010.015

0012.015



1150

CHIAVE A "T" SNODATA LUNGA - acciaio chrom-vanadium finitura cromata
WRENCH "T" HANDLE LONG - CARDANIC - chrom-vanadium steel chrome plated finish

Pro
 INDUSTRIAL



Model	Size (mm)	Length (mm)	Weight (kg)	Pcs	Barcode	Price (€)
1150.060	6	400	242	2	8011578928063	28,00
1150.070	7	400	186	2	8011578928094	28,00
1150.080	8	400	184	2	8011578928124	28,00
1150.090	9	400	248	2	8011578928155	29,00
1150.100	10	440	292	2	8011578928186	29,00
1150.110	11	460	376	2	8011578928216	33,50
1150.120	12	460	296	2	8011578928247	33,50
1150.130	13	460	392	2	8011578928278	33,50
1150.140	14	460	390	2	8011578928308	40,00
1150.150	15	460	588	2	8011578928339	40,00
1150.160	16	500	556	2	8011578928360	40,00
1150.170	17	500	590	2	8011578928391	40,00
1150.180	18	500	552	2	8011578928421	49,00
1150.190	19	500	608	2	8011578928452	49,00
1150.200	20	500	636	2	8011578928483	49,00
1150.210	21	520	946	2	8011578928513	49,00
1150.220	22	520	940	2	8011578928544	49,00
1150.240	24	520	1394	2	8011578928575	49,00

1150X

SERIE 4 CHIAVI ESAGONO A "T" SNODATE
SET 4 HEXAGON CARDANIC WRENCHES "T" HANDLE

Contenuto-content:

- 1150.080 8
- 1150.100 10
- 1150.130 13
- 1150.170 17

serie - set
4

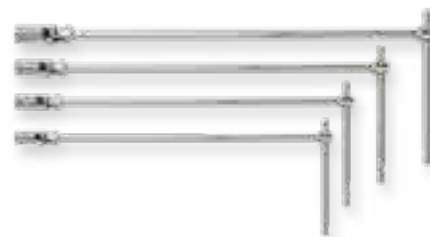

Model	Pz.	Weight (kg)	Barcode	Price (€)
1150.904	4	1472	8011578943721	130,50

1150FX

SERIE 7 CHIAVI ESAGONO A "T" SNODATE
SET 7 HEXAGON CARDANIC WRENCHES "T" HANDLE

Contenuto-content:

- 1150.070 7
- 1150.080 8
- 1150.100 10
- 1150.120 12
- 1150.130 13
- 1150.140 14
- 1150.170 17

serie - set
7



Model	Pz.	Weight (kg)	Barcode	Price (€)
1150.907	7	2330	8011578970642	232,00

1150Z

SERIE 18 CHIAVI A "T" SNODATE LUNGHE SET 18 WRENCHES "T" HANDLE LONG - CARDANIC

Contenuto-content:







1150.060	6	1150.150	15
1150.070	7	1150.160	16
1150.080	8	1150.170	17
1150.090	9	1150.180	18
1150.100	10	1150.190	19
1150.110	11	1150.200	20
1150.120	12	1150.210	21
1150.130	13	1150.220	22
1150.140	14	1150.240	24

 serie - set
18

	Pz.			€
1150.910	18	9600	8011578001582	696,50

1152







CHIAVE "T" SNODATA LUNGA ESAGONO MASCHIO WRENCH "T" HANDLE - CARDANIC - HEX MALE

						€	
1152.030	3	405	186	2	8011578938888	29,00	
1152.040	4	405	186	2	8011578938901	29,00	
1152.050	5	415	300	2	8011578938925	29,00	
1152.060	6	415	300	2	8011578938949	32,00	
1152.080	8	445	390	2	8011578938963	35,00	



1153







CHIAVE "T" SNODATA LUNGA TORX MASCHIO WRENCH "T" HANDLE - CARDANIC - TORX MALE

						€	
1153.020	TX 20	415	300	2	8011578974626	35,00	
1153.025	TX 25	415	300	2	8011578974640	35,00	
1153.027	TX 27	415	300	2	8011578974664	35,00	
1153.030	TX 30	415	300	2	8011578974688	38,50	
1153.040	TX 40	415	300	2	8011578974701	38,50	
1153.045	TX 45	415	300	2	8011578974725	40,00	



1155







CHIAVE A "T" SNODATA LUNGA ATTACCO PER CHIAVI A BUSSOLA - acciaio chrom-vanadium finitura cromata WRENCH "T" HANDLE LONG - CARDANIC FOR SOCKET - chrom-vanadium steel chrome plated finish

						€	
1155.005	1/4"	395	180	2	8011578928629	35,50	
1155.010	3/8"	438	375	2	8011578928605	38,00	
1155.020	1/2"	500	646	2	8011578928636	49,00	



1158

CHIAVE A "T" SNODATA LUNGA CANDELE WRENCH LONG "T" HANDLE - CARDANIC - SPARK PLUE

						€	
1158.140	14	480	610	2	8011578949587	46,00	
1158.160	16	480	614	2	8011578938840	51,00	
1158.200	21	480	640	2	8011578938864	67,50	



1170 CHIAVE A "T" SNODATA CANDELE
 WRENCH "T" HANDLE - CARDANIC - SPARK PLUE



Icona	Ø	L	Info	Imb.	Barcode	€
					011578 000004	
1170.016	16	240	248	2	8011578967482	7,35
1170.021	21	240	242	2	8011578967505	7,35

1325 CHIAVI A "T" CORTE - acciaio finitura nichelata
 "T" HANDLE SHORT WRENCHES - steel nickel plated finish



Icona	Ø	L	Info	Imb.	Barcode	€
					011578 000004	
1325.070	7	80 x 70	42	6	8011578928759	6,90
1325.080	8	95 x 85	60	6	8011578928780	7,00
1325.100	10	115 x 100	90	6	8011578928841	8,20
1325.120	12	115 x 100	95	6	8011578928902	10,05
1325.130	13	135 x 125	166	6	8011578928933	10,15

1328 CHIAVE A "T" - acciaio chrom-vanadium finitura cromata
 "T" HANDLE WRENCH - chrom-vanadium steel chrome plated finish



Icona	Ø	L	Info	Imb.	Barcode	€
					011578 000004	
1328.060	6	215	130	2	8011578936907	13,10
1328.070	7	215	155	2	8011578936921	13,10
1328.080	8	235	190	2	8011578936945	13,10
1328.090	9	235	256	2	8011578936969	13,10
1328.100	10	260	258	2	8011578936983	15,45
1328.110	11	260	288	2	8011578937003	15,45
1328.120	12	260	330	2	8011578937027	18,70
1328.130	13	260	304	2	8011578937041	18,70
1328.140	14	260	453	2	8011578937065	24,00
1328.150	15	285	438	2	8011578937089	24,00
1328.160	16	285	414	2	8011578937102	30,00
1328.170	17	285	492	2	8011578937126	30,10
1328.180	18	285	538	2	8011578937140	30,60
1328.190	19	310	568	2	8011578937164	30,60
1328.220	22	310	735	2	8011578937188	39,90
1328.240	24	310	1000	2	8011578937201	42,35

1328.904 SERIE 4 CHIAVI ESAGONO A "T" - acciaio chrom-vanadium finitura cromata
 SET 4 HEXAGON "T" HANDLE WRENCHES - chrom-vanadium steel chrome plated finish

serie-set
4

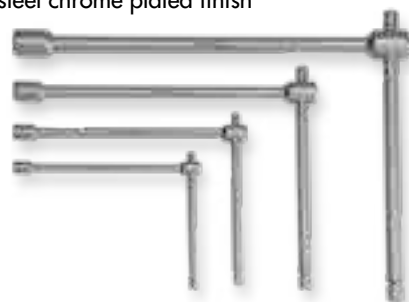

Contenuto-content:
 1328.080 8 235
 1328.100 10 260
 1328.130 13 260
 1328.170 17 285

Icona	Pz.	Info	Barcode	€
			011578 000004	
1328.904	4	1232	8011578943745	77,35

1334 CHIAVE RUOTE AUTOCARRO - acciaio chrom-vanadium finitura cromata

HEAVY DUTY WHEEL WRENCH - chrom-vanadium steel chrome plated finish



Icon	Size	Weight	Qty	Barcode	Price
	1334.270	27 x 30	2000	2 8011578937225	30,10
	1334.272	27 x 32	2100	2 8011578937249	30,10
	1334.303	30 x 33	2200	2 8011578937263	30,10

1334Z BARRA

BAR



Icon	Size	Weight	Qty	Barcode	Price
	1334.910	19 x 400	800	2 8011578937287	9,85

1336 CHIAVE A CROCIERA PER RUOTE

CROSS WHEEL WRENCH



Icon	Size	Weight	Qty	Barcode	Price
	1336.179	17 x 19 x 22 x 1/2"	380	16 1350 1 8011578937348	12,95
	1336.247	24 x 27 x 32 x 3/4"	625	22 4100 1 8011578937362	56,90

1338 LEVAGOMME

TIRE LEVEL



Icon	Size	Weight	Qty	Barcode	Price
	1338.050	mm 500	733	2 8011578948764	18,90

1339 LEVERINO

LEVEL



Icon	Size	Weight	Qty	Barcode	Price
	1339.010	450 x 16 mm. 20	2	8011578969967	14,25



1345 STRETTOIO A VITE - acciaio forgiato - finitura cromata
 CLAMP WITH SCREW - forged - chrome finish

Model	W	L	H	Wt	PK	Barcode	Price
1345.250	250	120	22,00	10,50	1200	8011578948566	32,50
1345.300	300	140	25,00	12,00	1800	8011578948580	44,65
1345.400	400	120	25,00	12,00	1900	8011578948603	47,00
1345.500	500	120	25,00	12,00	2100	8011578948627	50,00
1345.600	600	120	25,00	12,00	2300	8011578948641	54,50



1347 STRETTOIO A LEVA CHIUSURA RAPIDA - acciaio forgiato - finitura cromata
 QUICKLY ADJUSTABLE CLAMP - forged - chrome finish

Model	W	L	H	Wt	PK	Barcode	Price
1347.250	250	120	22,00	10,50	2400	8011578948665	54,50
1347.300	300	140	25,00	12,00	2500	8011578948689	77,15
1347.400	400	120	25,00	12,00	2800	8011578948702	77,70
1347.500	500	120	25,00	12,00	3000	8011578948726	81,20



1348 MORSETTO
 CLAMP

Model	W	L	H	Wt	PK	Barcode	Price
1348.007	75	56			800	8011578973940	15,90
1348.010	100	71			950	8011578973964	20,15
1348.015	150	93			1100	8011578984625	33,40



1349 MORSA - con serratubo - ACCIAIO
 VICE - with pipe - STEEL

Model	W	L	H	Wt	PK	Barcode	Price
1349.010	100				6000	8011578974008	85,90
1349.012	125				11000	8011578974022	152,95
1349.015	150				20400	8011578974046	244,75



1349... MORSA CON BASE GIREVOLE - con serratubo - ACCIAIO
 VICE WITH WITH SWIVEL BASE - with pipe - STEEL

Model	W	L	H	Wt	PK	Barcode	Price
1349.110	100				7000	8011578974060	96,50
1349.112	125				12600	8011578974084	169,45
1349.115	150				22400	8011578974107	264,75







1349... BASE GIREVOLE PER MORSA
 SWIVEL BASE





Model	W	L	H	Wt	PK	Barcode	Price
1349.810	100				1000	8011578974121	10,60
1349.812	125				1500	8011578974145	16,50
1349.815	150				2000	8011578974169	20,00







1350
CHIAVE A SETTORE SNODATA NASELLO QUADRO - acciaio chrom-vanadium finitura cromata
 FLEX HOOK WRENCH - SQUARE NOSE - chrom-vanadium steel chrome plated finish

	∅	H-L				€
1350.035	15÷35	168	100	1	8011578940485	15,55
1350.050	35÷50	202	187	1	8011578940508	28,75
1350.080	50÷80	280	405	1	8011578940522	35,50
1350.120	80÷120	345	724	1	8011578940546	48,30
1350.180	120÷180	492	1294	1	8011578940560	67,50

1351
CHIAVE A SETTORE NASELLO TONDO - acciaio chrom-vanadium finitura cromata
 HOOK WRENCH - ROUND NOSE - chrom-vanadium steel chrome plated finish



	∅	H-L				€
1351.035	15÷35	168	100	1	8011578984465	19,65 new
1351.050	35÷50	202	187	1	8011578984502	34,20 new
1351.080	50÷80	280	405	1	8011578984540	41,65 new
1351.120	80÷120	345	724	1	8011578985165	56,40 new
1351.180	120÷180	492	1294	1	8011578984663	79,90 new

1352
CHIAVE A SETTORE FISSA NASELLO QUADRO - acciaio chrom-vanadium finitura cromata
 FIX HOOK WRENCH - SQUARE NOSE - chrom-vanadium steel chrome plated finish

	∅	H-L				€
1352.028	25÷28	135	56	1	8011578940584	5,00
1352.032	30÷32	135	56	1	8011578940607	5,00
1352.036	34÷36	170	56	1	8011578940621	7,20
1352.042	40÷42	170	92	1	8011578940645	7,20
1352.050	45÷50	205	152	1	8011578940669	9,90
1352.055	52÷55	205	154	1	8011578940683	9,90
1352.062	58÷62	240	245	1	8011578940706	14,10
1352.075	68÷75	240	240	1	8011578940720	14,10
1352.090	80÷90	280	380	1	8011578940744	20,65
1352.100	98÷100	280	367	1	8011578940768	20,65
1352.115	110÷115	335	662	1	8011578940782	30,75
1352.130	120÷130	335	646	1	8011578940805	30,75
1352.145	135÷145	385	1134	1	8011578940829	45,50
1352.165	155÷165	385	1134	1	8011578940843	45,50
1352.195	180÷195	465	1140	1	8011578940867	73,25
1352.220	205÷220	465	1140	1	8011578972004	73,25

1360 CHIAVE A NASTRO PER FILTRI OLIO
 OIL FILTER WRENCH

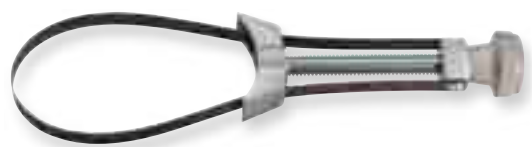
Icona	Ø	Info	Quantità	Barcode	Prezzo
					€
1360.011	65-110	250	2	8011578944124	11,00
1360.015	110-155	256	2	8011578944148	12,00



1360A NASTRO PER CHIAVI FILTRI OLIO art. 1360
 SPARE FOR OIL FILTER WRENCHES art. 1360

Icona	Info	Quantità	Barcode	Prezzo	
				€	
1360.211	110	14	1	8011578964665	2,40
1360.215	155	17	1	8011578964689	2,50



1362 CHIAVE A CATENA PER FILTRI OLIO ATTACCO 1/2"
 OIL FILTER WRENCH CHAIN 1/2"

Icona	Ø	Info	Quantità	Barcode	Prezzo
					€
1362.015	60-115	388	1	8011578944162	53,50



1363 CHIAVE A CATENA CON MANICO SNODATO PER FILTRI OLIO
 OIL FILTER WRENCH WITH FLEX HANDLE

Icona	Ø	Info	Quantità	Barcode	Prezzo
					€
1363.015	60-115	766	1	8011578944186	73,30



1364 CHIAVE A NASTRO
 OIL FILTER WRENCH

Icona	Ø	Info	Quantità	Barcode	Prezzo
					€
1364.010	60-140	200	1	8011578969981	16,20



1365 CASSETTA 14 CHIAVI PER TAPPI OLIO - 3/8"
 SET 14 SOCKETS FOR OIL CAPS - 3/8"

Contenuto-content:
 esagono-hexagon: mm. 8 9 10 12 14 17
 quadro-square: mm. 7 8 11 13 5/16" 3/8"
 quadro femmina-female square mm. 10
 triangolo-triangular

Icona	Info	Quantità	Barcode	Prezzo	
				€	
1365.010	220 x 90 x 50	784	1	8011578944346	57,20



1366
CHIAVE TAPPI OLIO
WRENCH FOR OIL CAPS









1366.010 290 mm 8 x 10 257 **6** 8011578971380 **7,75**

1367
SERIE 30 CHIAVI A TAZZA FILTRI OLIO
SET 30 CUP FILTER WRENCHES

Contenuto - content:
 diametri da 65 mm a 108 mm
 lati da 6 a 45
 3/8" M - 1/2" F







1367.010 620 x 510 x 90 7100 8011578964702 **175,95**

1369
SERIE 37 UTENSILI PISTONCINI FRENI 3/8"
SET 37 BRAKE CALIPER TOOLS 3/8"

Contenuto - content:
 mandrini di rotazione destro e sinistro
 left and right helix bolt







1369.010 435 x 305 x 60 4250 8011578964726 **194,25**

1370
CHIAVE CONNETTORI FRENI
FLAT NUT WRENCH









1370.101 10 x 11 175 106 **6** 8011578964740 **11,70**

1371 PRESSORE MOLLE AMMORTIZZATE - 3 PAIA GRAFFE
 MACPHERSON SPRING DUMPER EXTRACTOR

lunghezza/length 453 mm
 capacità graffe 80-115 mm
 88-160 mm
 126-212 mm
 NM 10.250 MAX

    €
1371.010 510 x 440 x 120 14700 8011578964764 **490,60**



1380 SERIE 7 PINZE FASCETTE STRINGITUBO
 SET 7 UNIVERSAL HOSE CLAMP PLIERS

    €
1380.010 48 x 380 x 100 3200 8011578964788 **225,20**



1383 PINZA FASCETTA STRINGITUBO CON CAVO mm 630
 HOSE CLAMP PLIER WITH CABLE mm 630

     €
1383.010 210-630 470 1 8011578964801 **60,25**



1385 PINZA FASCETTA PUNTE GIR. 45° - MANICOTTI
 HOSE CLAMP PLIER 45°

     €
1385.010 235 226 1 8011578964825 **20,90**



1386 PINZA FASCETTA A SCATTO CLIC
 CLIP-R COLLAR PLIER

     €
1386.010 175 250 1 8011578964849 **17,25**



1388 PINZA FASCETTE - CON ARRESTO VARIE POSIZIONI

HOSE CLAMP PLIER - MULTI-STOP



						
1388.038	mm 6-38	240	320	2	8011578964863	35,65
1388.055	mm 22-55	240	334	2	8011578964887	38,10

1390 SERIE 3 PINZE PER STROZZATURA MANICOTTI ACQUA E BENZINA

SET 3 CLAMP PLIERS FOR NARROW WATER AND PETROL PIPE

Contenuto - content:
 22-60 mm - 63 mm
 22-42 mm - 29 mm
 11-19 mm - 18 mm



	mm			
1390.010	150-180-250	226	8011578964900	31,30

1391 PRENDITUTTO FLESSIBILE MAGNETICO E GRIFFA

PICK-UP TOOL MAGNETIC AND CLAW



					
1391.010	700	145	1	8011578971403	20,30

1393 CASSETTA 6 BUSSOLE 3/8" PER CANDELETTE

BLOW CASE 6 SOCKETS 3/8" GLOW PLUG

Contenuto - content:
 MM 8-9-10-12-14-16



			
1393.010	800	8011578972509	57,65

1394 CASSETTA 15 CHIAVI PER TENDITORE CINGHIA

BLOW CASE 15 TENSION PULLER WRENCHES













Contenuto - content:
 TORX E10 - E12 - E14 - E16 - E18
 ESAGONO - HEX mm 10 - 13 - 14 - 15 - 16 - 17 - 18 - 19



			
1394.010	1540	8011578972448	120,00

1400 CHIAVE A BUSSOLA 1/4" BOCCA ESAGONALE PROFILO FLANK DRIVE - acciaio chrom-vanadium finitura cromata
 SOCKET 1/4" HEXAGON FLANK DRIVE SECTION - chrom-vanadium steel chrome plated finish

DIN 3124 ISO 2725

Icona	Modello	Spessore	Lunghezza	Altezza	Spessore	Spessore	Quantità	Barcode	Prezzo
	1400.040	4	25	6,7	12	10	6	8011578929084	1,50
	1400.045	4,5	25	7,3	12	11	6	8011578929114	1,50
	1400.050	5	25	8	12	11	6	8011578929145	1,50
	1400.055	5,5	25	8,5	12	12	6	8011578929176	1,50
	1400.060	6	25	9	12	12	6	8011578929206	1,50
	1400.070	7	25	10	12	12	6	8011578929237	1,50
	1400.080	8	25	11,8	12	12	6	8011578929268	1,55
	1400.090	9	25	12,5	12	14	6	8011578929299	1,55
	1400.100	10	25	14	12	14	6	8011578929329	1,65
	1400.110	11	25	15,5	14	20	6	8011578929350	1,70
	1400.120	12	25	17	15	22	6	8011578929381	1,80
	1400.130	13	25	18	16	25	6	8011578929411	1,90

1/4"



1400Z SERIE 12 CHIAVI A BUSSOLA 1/4" - binario
 SET 12 SOCKETS 1/4" - holding bar

Contenuto-content:

1400.040	1400.055	1400.080	1400.110
1400.045	1400.060	1400.090	1400.120
1400.050	1400.070	1400.100	1400.130

1/4"



Icona	Modello	Quantità	Barcode	Prezzo
	1400.912	194	8011578944360	23,65













1400ZZ BINARIO PER BUSSOLE 1/4" mm 185 - vuoto
 HOLDING BAR FOR SOCKETS 1/4" mm 185 - empty

1/4"



Icona	Modello	Quantità	Barcode	Prezzo
	1400.990	185	8011578944384	4,50

1402 CHIAVE A BUSSOLA 1/4" LUNGA
 SOCKET 1/4" DEEP

Icona	Modello	Spessore	Lunghezza	Altezza	Spessore	Spessore	Quantità	Barcode	Prezzo
	1402.040	4	50	11	7	15	6	8011578941185	2,40
	1402.045	4,5	50	12	7	17	6	8011578941208	2,40
	1402.050	5	50	12	8	18	6	8011578941222	2,40
	1402.055	5,5	50	12	9	20	6	8011578941246	2,40
	1402.060	6	50	12	9	20	6	8011578941260	2,40
	1402.070	7	50	12	11	22	6	8011578941284	2,40
	1402.080	8	50	12	12	23	6	8011578941307	2,40
	1402.090	9	50	13	13	30	6	8011578941321	2,55
	1402.100	10	50	14	14	38	6	8011578941345	2,55
	1402.110	11	50	16	16	42	6	8011578941369	2,90
	1402.120	12	50	17	17	48	6	8011578941383	3,05
	1402.130	13	50	18	18	50	6	8011578941406	3,05
	1402.140	14	50	19	19	68	6	8011578941420	3,65

1/4"



1402Z SERIE 12 CHIAVI A BUSSOLA 1/4" LUNGHE - binario
 SET 12 SOCKETS 1/4" LONG - holding bar

Contenuto-content:

1402.040	1402.055	1402.080	1402.110
1402.045	1402.060	1402.090	1402.120
1402.050	1402.070	1402.100	1402.130

1/4"



Icona	Modello	Quantità	Barcode	Prezzo
	1402.912	368	8011578944407	35,40

1404 CHIAVE A BUSSOLA 1/4" FEMMINA TX E SOCKET 1/4" TX E FEMALE

Icona	Modello	Spessore	Lunghezza	Altezza	Spessore	Quantità	Barcode	Prezzo
	1404.040 E 4	25	12	7	10	6	8011578944421	2,65
	1404.050 E 5	25	12	7	10	6	8011578944445	2,65
	1404.060 E 6	25	12	8	11	6	8011578944469	2,65
	1404.070 E 7	25	12	9	12	6	8011578944483	2,65
	1404.080 E 8	25	12	10	12	6	8011578944506	2,65
	1404.100 E 10	25	12	13	18	6	8011578944520	2,75

1/4"



1404Z SERIE 6 CHIAVI A BUSSOLA TORX 1/4" - binario SET 6 SOCKETS TORX 1/4" - holding bar

Contenuto-content:

1404.040 E 4	1404.060 E 6	1404.080 E 8
1404.050 E 5	1404.070 E 7	1404.100 E 10

Icona	Modello	Quantità	Barcode	Prezzo
	1404.906	102	8011578944544	20,50

1/4"



1405 CRICCHETTO REVERSIBILE 1/4" CON SGANCIO RAPIDO - acciaio chrom-vanadium finitura cromata - impugnatura plastica RATCHET 1/4" REVERSIBLE QUICK RELEASE - chrom-vanadium steel chrome plated finish - plastic handle

Pro
INDUSTRIAL

72 denti - teeth

1/4"

Icona	Modello	Lunghezza	Spessore	Spessore	Quantità	Barcode	Prezzo	
	1405.010	145	19 x 24	70	118	2	8011578929442	24,90



1405.2 CRICCHETTO REV. 1/4" CON SGANCIO RAPIDO - acciaio chrom-vanadium finitura cromata - imp. bicomponente RATCHET 1/4" REVERSIBLE QUICK RELEASE - chrom-vanadium steel chrome plated finish - bicomponent handle

Pro
INDUSTRIAL

72 denti - teeth

1/4"

Icona	Modello	Lunghezza	Spessore	Spessore	Quantità	Barcode	Prezzo	
	1405.210	155	22 x 27	70	135	2	8011578977467	17,85 new



1405Z CRICCHETTO REVERSIBILE 1/4" TELESCOPICO - SNODATO - acciaio chrom-vanadium finitura cromata RATCHET 1/4" REVERSIBLE TELESCOPIC - FLEX - chrom-vanadium steel chrome plated finish

72 denti - teeth

1/4"

Icona	Modello	Lunghezza	Spessore	Spessore	Quantità	Barcode	Prezzo	
	1405.910	255/355	32 x 33	90	505	2	8011578969165	25,85



1406 CRICCHETTO REVERSIBILE 1/4" - sgancio rapido RATCHET 1/4" REVERSIBLE - quick release

72 denti - teeth

1/4"

Icona	Modello	Lunghezza	Spessore	Spessore	Quantità	Barcode	Prezzo	
	1406.010	150	26 x 26	70	186	2	8011578940089	13,90



1407

CRICCHETTO DOPPIO 1/4" FEMMINA ESAGONO PER INSERTI - 1/4" MASCHIO QUADRO PER BUSSOLE
DOUBLE RATCHET EXAGONAL FEMALE BITS 1/4" - 1/4" SQUARE MALE FOR SOCKETS

1/4"



						
1407.010	100	27 x 25	110	6	8011578964924	15,35

1408

PROLUNGA 1/4" - acciaio chrom-vanadium finitura cromata
EXTENSION BAR 1/4" - chrom-vanadium steel chrome plated finish

DIN 3122 ISO 3315

1/4"



					
1408.075	75	33	6	8011578929473	2,50
1408.150	150	66	6	8011578929503	3,85

1410

LEVA A "T" 1/4" - acciaio chrom-vanadium finitura cromata
SLIDING "T" BAR 1/4" - chrom-vanadium steel chrome plated finish

DIN 3322 ISO 3315

1/4"



					
1410.010	115	44	6	8011578929534	4,65

1412

SNODO CARDANICO 1/4" - acciaio chrom-vanadium finitura cromata
UNIVERSAL JOINT 1/4" - chrom-vanadium steel chrome plated finish

DIN 3123 ISO 3316

1/4"



					
1412.010	41	26	6	8011578929565	7,35

1414

IMPUGNATURA PORTA BUSSOLE 1/4" - acciaio chrom-vanadium finitura cromata impugnatura plastica
HANDLE FOR SOCKET 1/4" - chrom-vanadium steel chrome plated finish - plastic handle

DIN 3122 ISO 3315

1/4"









					
1414.010	60	67	2	8011578929596	6,35

1420

ADATTATORE 1/4" PORTAINSERI UNIVERSALE ESAGONO 1/4" (giraviti-esagoni-torx) - acc. chrom-vanadium fin. cromata
ADAPTER COUPLER 1/4" FOR HEXAGON BIT 1/4" (screwdriver-hexagon-torx) - chrom-vanadium steel chrome plated finish

1/4"







					
1420.010	26	14	6	8011578929626	3,45

1425

RACCORDO AUMENTATORE DA 1/4" F A 3/8" M
ADAPTER FROM 1/4" FEMALE TO 3/8" MALE

1/4" 3/8"









DIN 3123				
1425.010	20	6	8011578929657	2,90

1430

CHIAVE A BUSSOLA 1/4" - intaglio
SOCKET 1/4" - flat

1/4"



						
1430.300	3	33	12	6	8011578937386	1,85
1430.400	4	33	13	6	8011578937409	1,85
1430.500	5	33	13	6	8011578937423	1,85
1430.600	6	33	13	6	8011578937447	1,85

1432 CHIAVE A BUSSOLA 1/4" - phillips SOCKET 1/4" - phillips



1/4"

Icona	Modello	Spessore	Lunghezza	Quantità	Barcode	Prezzo
	PH 1	33	13	6	8011578937461	1,85
	PH 2	33	14	6	8011578937485	1,85
	PH 3	33	14	6	8011578937508	1,85

1436 CHIAVE A BUSSOLA 1/4" - esagonale maschio SOCKET 1/4" - hexagon male



1/4"

Icona	Modello	Spessore	Lunghezza	Quantità	Barcode	Prezzo
	3	33	13	6	8011578937584	1,85
	4	33	13	6	8011578937607	1,85
	5	33	14	6	8011578937621	1,85
	6	33	15	6	8011578937645	1,85
	8	33	17	6	8011578937669	1,85

1434 CHIAVE A BUSSOLA 1/4" - pozidriv SOCKET 1/4" - pozidriv



1/4"

Icona	Modello	Spessore	Lunghezza	Quantità	Barcode	Prezzo
	PZ 1	33	13	6	8011578937522	1,85
	PZ 2	33	14	6	8011578937546	1,85
	PZ 3	33	14	6	8011578937560	1,85

1438 CHIAVE A BUSSOLA 1/4" - torx con foro SOCKET 1/4" - torx with hole



1/4"

Icona	Modello	Spessore	Lunghezza	Quantità	Barcode	Prezzo
	TX 8	33	12	6	8011578937683	2,80
	TX 10	33	13	6	8011578937706	2,80
	TX 15	33	13	6	8011578937720	2,80
	TX 20	33	14	6	8011578937744	2,80
	TX 25	33	14	6	8011578937768	2,80
	TX 27	33	13	6	8011578937782	2,80
	TX 30	33	14	6	8011578937805	2,80
	TX 40	33	14	6	8011578937829	2,80

1440 CASSETTA 33 BUSSOLE 1/4" - mm 4 ÷ 13 - metallo METAL BOX 33 SOCKETS 1/4" mm 4 ÷ 13 - metal



1/4" 

Contenuto - content:

1400.040 4	1400.110 11	1430.300 3	1436.050 5
1400.045 4,5	1400.120 12	1430.400 4	1436.060 6
1400.050 5	1400.130 13	1430.500 5	1436.080 8
1400.055 5,5	1405.010 140	1430.600 6	0355.015 1,5
1400.060 6	1408.050 50	1430.700 7	0355.020 2
1400.070 7	1408.150 150	1432.100 1	0355.030 3
1400.080 8	1410.010 115	1432.200 2	
1400.090 9	1412.010	1436.030 3	
1400.100 10	1414.010	1436.040 4	

1440.010 245 x 120 x 40 1200 8011578960520 **63,80**

1442 VALIGETTA 46 BUSSOLE 1/4" - mm 4 ÷ 14 - plastica BLOW CASE 46 SOCKETS 1/4" - mm 4 ÷ 14 - plastic



1/4" 

Contenuto-content:

1400.040	1400.120	1436.030	1432.200	1438.400
1400.045	1400.130	1436.040	1432.300	0345.012
1400.050	1400.140	1436.050	1434.100	0345.015
1400.055	1405.210	1436.060	1434.200	0345.020
1400.060	1408.050	1436.070	1434.300	0345.025
1400.070	1408.100	1436.080	1438.100	0241.014
1400.080	1414.010	1430.400	1438.150	
1400.090	1410.010	1430.500	1438.200	
1400.100	1412.010	1430.600	1438.250	
1400.110	1408.910	1432.100	1438.300	

1442.010 235 x 170 x 50 1318 8011578002107 **57,00**



1450 CHIAVE A BUSSOLA 3/8" BOCCA ESAGONALE FLANK DRIVE - acciaio chrom-vanadium finitura cromata
 SOCKET 3/8" HEXAGON FLANK DRIVE SECTION - chrom-vanadium steel chrome plated finish

DIN 3124 ISO 2725

3/8"



Model	Teeth	Length	Width	Height	Weight	Quantity	Barcode	Price
1450.060	6	25	9,8	17	20	6	8011578929718	2,15
1450.070	7	25	10,8	17	20	6	8011578929749	2,15
1450.080	8	25	12,3	17	20	6	8011578929770	2,15
1450.090	9	25	13,5	17	23	6	8011578929800	2,15
1450.100	10	25	14,5	17	23	6	8011578929831	2,25
1450.110	11	25	15,5	17	25	6	8011578929862	2,25
1450.120	12	25	16,0	17	24	6	8011578929893	2,25
1450.130	13	25	18,0	17	26	6	8011578929923	2,35
1450.140	14	28	19,8	18	31	6	8011578929954	2,65
1450.150	15	28	21,8	18	40	6	8011578929985	2,85
1450.160	16	28	21,8	20	36	6	8011578930011	2,85
1450.170	17	30	23,8	20	48	6	8011578930042	3,00
1450.180	18	30	25,0	21	62	6	8011578930073	3,00
1450.190	19	30	26,0	21	56	6	8011578930103	3,25
1450.200	20	30	27,8	23	65	6	8011578930134	3,35
1450.210	21	32	27,8	23	65	6	8011578930165	3,50
1450.220	22	32	29,8	26	81	6	8011578930196	4,05

1455 CRICCHETTO REVERSIBILE 3/8" CON SGANCIO RAPIDO - acciaio chrom-vanadium finitura cromata - impugnatura plastica
 RATCHET 3/8" REVERSIBLE QUICK RELEASE - chrom-vanadium steel chrome plated finish - plastic handle

72 denti - teeth

3/8"



DIN 3122 ISO 3315

Model	Teeth	Length	Width	Height	Weight	Quantity	Barcode	Price
1455.010	196	31 x 30	82	250	2	6	8011578930226	29,40

1455.2 CRICCHETTO REV. 3/8" CON SGANCIO RAPIDO - acciaio chrom-vanadium finitura cromata - imp. bicomponente
 RATCHET 3/8" REVERSIBLE QUICK RELEASE - chrom-vanadium steel chrome plated finish - bicomponent handle

72 denti - teeth

3/8"



DIN 3122 ISO 3315

Model	Teeth	Length	Width	Height	Weight	Quantity	Barcode	Price
1455.210	196	31 x 30	90	300	2	6	8011578977481	22,30 new

1458 PROLUNGA 3/8" - acciaio chrom-vanadium finitura cromata
 EXTENSION BAR 3/8" - chrom-vanadium steel chrome plated finish

DIN 3123 ISO 3316

3/8"



Model	Length	Weight	Quantity	Barcode	Price
1458.075	75	76	6	8011578930257	4,05
1458.150	150	138	6	8011578930288	5,55

1460 LEVA A "T" 3/8" - acciaio chrom-vanadium finitura cromata
 SLIDING "T" BAR 3/8" - chrom-vanadium steel chrome plated finish

DIN 3122 ISO 3315

3/8"



Model	Length	Weight	Quantity	Barcode	Price
1460.010	165	154	6	8011578930318	8,30

1462
SNODO CARDANICO 3/8" - acciaio chrom-vanadium finitura cromata
UNIVERSAL JOINT 3/8" - chrom-vanadium steel chrome plated finish

DIN 3123 ISO 3316

3/8"







					
1462.010	57	69	6	8011578930349	9,15

1470
ADATTATORE 3/8" PORTAINERTI UNIVERSALE ESAGONO 1/4" (giraviti-esagoni-torx) - acc. chrom-vanadium fin. cromata
ADAPTER COUPLER 3/8" FOR HEXAGON BIT 1/4" (screwdriver-hexagon-torx) - chrom-vanadium steel chrome plated finish
3/8"







					
1470.010	29	24	6	8011578930370	3,85

1475
RACCORDO DA 3/8" FEMMINA A MASCHIO - acciaio chrom-vanadium finitura cromata
ADAPTER FROM 3/8" FEMALE TO MALE - chrom-vanadium steel chrome plated finish
3/8"

DIN 3123 ISO 3316

					
1475.010	1/4" Maschio-Male riduttore/reduction	31	6	8011578930400	2,90
1475.020	1/2" Maschio-Male aumento/increase	51	6	8011578930431	3,00

1477
CHIAVE A BUSSOLA 3/8" PER CANDELE BOCCA ESAGONALE PROFILO FLANK DRIVE - acc. chrom-vanadium fin. cromata
SOCKET 3/8" FOR SPARK PLUNG HEXAGON FLANK DRIVE SECTION - chrom-vanadium steel chrome plated finish
3/8"

							
1477.160	16	65	22	96	6	8011578930462	4,75
1477.210	21	65	28	143	6	8011578930493	5,95

1490
CASSETTA 22 BUSSOLE E ACCESSORI 3/8" - mm 6 ÷ 22 - metallo
METAL BOX 22 SOCKETS AND ACCESSORIES 3/8" - mm 6 ÷ 22 - metal
3/8"

Contenuto-content:

1450.060	6	1450.170	17
1450.070	7	1450.180	18
1450.080	8	1450.190	19
1450.090	9	1450.220	22
1450.100	10	1455.010	
1450.110	11	1458.075	
1450.120	12	1458.150	
1450.130	13	1460.010	
1450.140	14	1462.010	
1450.150	15	1477.160	
1450.160	16	1477.210	



				
1490.010	320 x 150 x 50	2300	8011578960544	91,65

1500

CHIAVE A BUSSOLA 1/2" BOCCA ESAGONALE PROFILO FLANK DRIVE - acciaio chrom-vanadium finitura cromata
SOCKET 1/2" HEXAGON FLANK DRIVE SECTION - chrom-vanadium steel chrome plated finish

Articolo	Spessore	Lunghezza	Spessore	Lunghezza	Spessore	Spessore	Barcode	Prezzo
1500.080	8	38	13,0	22	48	6	8011578942786	2,75
1500.090	9	38	14,0	22	48	6	8011578942809	2,75
1500.100	10	38	15,0	22	48	6	8011578930585	2,75
1500.110	11	38	16,8	22	50	6	8011578930615	2,75
1500.120	12	38	17,9	22	52	6	8011578930646	2,75
1500.130	13	38	18,7	22	52	6	8011578930677	2,85
1500.140	14	38	20,0	22	55	6	8011578930707	2,85
1500.150	15	38	21,8	21	56	6	8011578930738	2,85
1500.160	16	38	22,0	21	49	6	8011578930769	3,05
1500.170	17	38	23,0	22	63	6	8011578930790	3,45
1500.180	18	38	25,8	24	76	6	8011578930820	3,45
1500.190	19	38	25,8	24	67	6	8011578930851	3,55
1500.200	20	38	27,8	26	87	6	8011578930882	3,75
1500.210	21	38	29,3	26	82	6	8011578930912	4,30
1500.220	22	38	30,0	28	96	6	8011578930943	4,30
1500.230	23	38	31,7	29	113	6	8011578930974	5,30
1500.240	24	38	32,0	29	105	6	8011578931001	5,40
1500.250	25	42	34,0	31	138	6	8011578931032	5,55
1500.260	26	42	35,0	33	133	6	8011578931063	5,80
1500.270	27	42	36,0	31	150	6	8011578931094	5,95
1500.280	28	42	38,0	34	176	6	8011578931124	6,25
1500.300	30	42	38,0	34	188	6	8011578931155	6,45
1500.320	32	42	42,0	38	210	6	8011578931186	6,80

DIN 3124 ISO 2725

1/2"



1500Z

SERIE 10 CHIAVI A BUSSOLA 1/2" - binario
SET 10 SOCKETS 1/2" - holding bar

Contenuto-content:

1500.080	1500.100	1500.120	1500.150	1500.190
1500.090	1500.110	1500.130	1500.170	1500.220

1/2"

Articolo	Spessore	Barcode	Prezzo
1500.910	606	8011578944902	35,50



1500ZZ

BINARIO PER BUSSOLE 1/2" - mm 260 - vuoto
HOL. BAR FOR SOCKETS 1/2" - mm 260 - empty

Articolo	Spessore	Spessore	Barcode	Prezzo
1500.990	260	48	8011578944889	4,75

1/2"



1501

CHIAVE A BUSSOLA 1/2" BOCCA POLIGONALE - acciaio chrom-vanadium finitura cromata
SOCKET 1/2" BIHEXAGONAL - chrom-vanadium steel chrome plated finish

Articolo	Spessore	Lunghezza	Spessore	Lunghezza	Spessore	Spessore	Barcode	Prezzo
1501.080	8	38	13,0	22	48	6	8011578964948	2,75
1501.090	9	38	14,0	22	48	6	8011578964962	2,75
1501.100	10	38	15,0	22	48	6	8011578964986	2,75
1501.110	11	38	16,8	22	50	6	8011578965006	2,75
1501.120	12	38	17,9	22	52	6	8011578965020	2,75
1501.130	13	38	18,7	22	52	6	8011578965044	2,85
1501.140	14	38	20,0	22	55	6	8011578965068	2,85
1501.150	15	38	21,8	21	56	6	8011578965082	2,85
1501.160	16	38	22,0	21	49	6	8011578965105	3,05
1501.170	17	38	23,0	22	63	6	8011578965129	3,45
1501.180	18	38	25,8	24	76	6	8011578965143	3,45
1501.190	19	38	25,8	24	67	6	8011578965167	3,55
1501.200	20	38	25,8	24	67	6	8011578975586	4,30
1501.210	21	38	29,3	26	82	6	8011578965181	4,30
1501.220	22	38	30,0	28	96	6	8011578965204	4,30
1501.230	23	42	42,0	38	210	6	8011578984748	5,30 new
1501.240	24	38	32,0	29	105	6	8011578965228	5,40
1501.260	26	42	42,0	38	210	6	8011578984786	5,80 new
1501.270	27	42	36,0	31	150	6	8011578965242	5,95
1501.280	28	42	42,0	38	210	6	8011578984823	6,25 new
1501.300	30	42	38,0	34	188	6	8011578965266	6,45
1501.320	32	42	42,0	38	210	6	8011578965280	6,80

DIN 3124 ISO 2725

1/2"



**POLIGONALE
 BIHEXAGONAL**

1501Z

SERIE 10 CHIAVI A BUSSOLA POLIGONALI 1/2" - binario
 SET 10 POLYGONAL SOCKETS 1/2" - holding bar

1/2"

Contenuto-content:









1501.080 1501.100 1501.120 1501.150 1501.190
 1501.090 1501.110 1501.130 1501.170 1501.220



 **1501.910**  606  8011578965303  **35,50**

1502

CHIAVE A BUSSOLA 1/2" LUNGA
 SOCKET 1/2" DEEP

								
1502.100	10	77	22	16	84	6	8011578940140	6,25
1502.110	11	77	22	16	90	6	8011578940164	6,25
1502.120	12	77	22	18	98	6	8011578940188	6,25
1502.130	13	77	22	19	107	6	8011578940201	6,25
1502.140	14	77	22	21	110	6	8011578940225	6,25
1502.150	15	77	22	22	120	6	8011578940249	6,25
1502.160	16	77	22	22	109	6	8011578940263	6,25
1502.170	17	77	24	24	142	6	8011578960506	6,35
1502.180	18	77	26	26	178	6	8011578940300	6,55
1502.190	19	77	26	26	163	6	8011578940324	6,55
1502.210	21	77	28	28	187	6	8011578940362	7,00
1502.220	22	77	30	30	227	6	8011578940386	7,20
1502.240	24	77	32	32	253	6	8011578940409	8,00
1502.270	27	77	36	36	340	6	8011578940423	10,65
1502.300	30	77	40	40	425	6	8011578940447	11,40
1502.320	32	77	42	42	452	6	8011578940461	12,10

1/2"



1502Z

SERIE 10 CHIAVI A BUS. LUNGHE 1/2" - binario
 SET 10 SOCKETS 1/2" LONG - holding bar

1/2"

Contenuto-content:

1502.100 1502.120 1502.140 1502.170 1502.220
 1502.110 1502.130 1502.150 1502.190 1502.240









 **1502.910**  1426  8011578944926  **70,35**

1504

CHIAVE A BUSSOLA 1/2" BOCCA POLIGONALE in POLLICI - acciaio chrom-vanadium finitura cromata
 SOCKET 1/2" POLYGONAL in INCH - chrom-vanadium steel chrome plated finish

DIN 3124 ISO 2725

						
1504.010	3/8"	38	48	6	8011578962166	3,70
1504.020	7/16"	38	48	6	8011578962180	3,70
1504.030	1/2"	38	54	6	8011578962203	3,70
1504.040	9/16"	38	52	6	8011578962227	3,70
1504.050	5/8"	38	48	6	8011578962241	3,70
1504.060	19/32"	38	52	6	8011578962265	3,70
1504.070	11/16"	38	60	6	8011578962289	4,70
1504.080	3/4"	38	64	6	8011578962302	4,70
1504.090	25/32"	38	76	6	8011578962326	4,70
1504.100	13/16"	38	78	6	8011578962340	4,70
1504.110	7/8"	38	90	6	8011578962364	5,35
1504.120	15/16"	38	104	6	8011578962388	5,35
1504.130	1"	42	132	6	8011578962401	6,20
1504.140	1.1/16"	42	130	6	8011578962425	6,20
1504.150	1.1/8"	42	156	6	8011578962449	7,40
1504.160	1.3/16"	42	184	6	8011578962463	7,40
1504.170	1.1/4"	42	202	6	8011578962487	7,40

1/2"

POLLICI
 INCH



1504Z SERIE 17 CHIAVI A BUSSOLA 1/2" in POLLICI - binario
 SET 17 SOCKETS 1/2" in INCH - holding bar

1/2"

POLLICI
INCH

Contenuto-content:

1504.010	1504.020	1504.030	1504.040	1504.050
1504.060	1504.070	1504.080	1504.090	1504.100
1504.110	1504.120	1504.130	1504.140	1504.150
1504.160	1504.170			

 **1504.910**

 1656

 8011578962500

€ **91,05**



1505 CRICCHETTO REVERSIBILE 1/2" CON SGANCIO RAPIDO - acciaio chrom-vanadium finitura cromata - impugnatura plastica
 RATCHET 1/2" REVERSIBLE QUICK RELEASE - chrom-vanadium steel chrome plated finish - plastic handle

72 denti - teeth

Pro
INDUSTRIAL

1/2"

DIN 3122 ISO 3315













 8011578931216

€ **39,50**

1505.010 254 41,5 x 39 105 563 **2**



1505.2 CRICCHETTO REV. 1/2" CON SGANCIO RAPIDO - acciaio chrom-vanadium finitura cromata - imp. bicomponente
 RATCHET 1/2" REVERSIBLE QUICK RELEASE - chrom-vanadium steel chrome plated finish - bicomponent handle

72 denti - teeth

Pro
INDUSTRIAL

1/2"

DIN 3122 ISO 3315













 8011578977504

€ **26,65** new

1505.210 254 40 x 39 110 595 **2**



1505Z CRICCHETTO REVERSIBILE 1/2" TELESCOPICO - SNODATO - acciaio chrom-vanadium finitura cromata
 RATCHET 1/2" REVERSIBLE TELESCOPIC - FLEX - chrom-vanadium steel chrome plated finish

72 denti - teeth

1/2"













 8011578967543

€ **45,85**

1505.910 340/480 43 x 42 110 1160 **2**



1506 CRICCHETTO REVERSIBILE 1/2" - sgancio rapido
 RATCHET 1/2" REVERSIBLE - quick release

72 denti - teeth

1/2"













 8011578940102

€ **20,65**

1506.010 254 40 x 40 105 560 **2**







1508
PROLUNGA 1/2" - acciaio chrom-vanadium finitura cromata
EXTENSION BAR 1/2" - chrom-vanadium steel chrome plated finish

DIN 3123 ISO 3316

					€	1/2"	
1508.125	125	197	6	8011578931247	5,55		
1508.250	250	388	6	8011578931278	9,15		

1509
PROLUNGA 1/2" ESTREMITÀ SFERICA INCLINABILE - acciaio chrom-vanadium finitura cromata
EXTENSION BAR 1/2" WOBBLE SPHERIC - chrom-vanadium steel chrome plated finish

DIN 3123 ISO 3316

					€	1/2"	
1509.125	125	215	6	8011578931308	15,50		
1509.250	250	417	6	8011578931339	15,95		

1510
LEVA A "T" 1/2" - acciaio chrom-vanadium finitura cromata
SLIDING "T" BAR 1/2" - chrom-vanadium steel chrome plated finish

DIN 3122 ISO 3315

					€	1/2"	
1510.010	250	360	6	8011578931360	9,90		

1512
SNODO CARDANICO 1/2" - acciaio chrom-vanadium finitura cromata
UNIVERSAL JOINT 1/2" - chrom-vanadium steel chrome plated finish

DIN 3123 ISO 3316

					€	1/2"	
1512.010	70	137	6	8011578931391	11,95		







1520
ADATTATORE 1/2" PORTAINSERTI UNIVERSALE ESAGONO 1/4" (giraviti-esagoni-torx) - acc. chrom-vanadium fin. cromata
ADAPTER COUPLER 1/2" FOR HEXAGON BIT 1/4" (screwdriver-hexagon-torx) - chrom-vanadium steel chrome plated finish

DIN 3123 ISO 3316









					€	1/2"	
1520.010		52	6	8011578949563	4,35		

1525
RACCORDO DA 1/2" FEMMINA - MASCHIO - acciaio chrom-vanadium finitura cromata
ADAPTER FROM 1/2" FEMALE - MALE - chrom-vanadium steel chrome plated finish

DIN 3123 ISO 3316

					€	1/2"	
1525.010	3/8" Maschio-Male riduttore/reduction	50	6	8011578931421	3,50		
1525.015	3/4" Maschio-Male aumento/increase	142	6	8011578943004	9,20		

1527
CHIAVE A BUSSOLA 1/2" PER CANDELE BOCCA ESAGONALE PROFILO FLANK DRIVE - acc. chrom-vanadium fin. cromata
SOCKET 1/2" FOR SPARK PLUNG HEXAGON FLANK DRIVE SECTION - chrom-vanadium steel chrome plated finish

							€	1/2"	
1527.160	16	65	22	94	6	8011578931452	4,60		
1527.210	21	65	28	141	6	8011578931483	6,35		

1530 CHIAVE A BUSSOLA 1/2" - esagonale maschio
 SOCKET 1/2" - hexagon male



1/2"

Art. No.	Ø	L	h	h	Barcode	€
1530.040	4	55	81	6	8011578937843	5,50
1530.050	5	55	85	6	8011578937867	5,50
1530.060	6	55	79	6	8011578937881	5,50
1530.080	8	55	87	6	8011578937904	5,50
1530.100	10	55	91	6	8011578937928	5,50
1530.120	12	55	101	6	8011578937942	5,55
1530.140	14	55	114	6	8011578937966	6,35
1530.170	17	55	149	6	8011578937980	6,75
1530.190	19	55	157	6	8011578938000	7,25

1530Z SERIE 9 BUSSOLE ESAGONO 1/2" - binario
 SET 9 SOCKETS HEX. 1/2" - holding bar



1/2"

Contenuto-content:

Art. No.	Ø	L	h	h	Barcode	€
1530.040	4	55	81	6	8011578937843	
1530.050	5	55	85	6	8011578937867	
1530.060	6	55	79	6	8011578937881	
1530.080	8	55	87	6	8011578937904	
1530.100	10	55	91	6	8011578937928	
1530.120	12	55	101	6	8011578937942	
1530.140	14	55	114	6	8011578937966	
1530.170	17	55	149	6	8011578937980	
1530.190	19	55	157	6	8011578938000	
1530.909			970		8011578944940	58,15

1531 CHIAVE A BUSS. 1/2" ESAG. MASCHIO - lunga
 SOCKET 1/2" HEX MALE - deep



1/2"

Art. No.	Ø	L	h	h	Barcode	€
1531.050	5	90	108	6	8011578941086	5,95
1531.060	6	90	110	6	8011578941109	5,95
1531.080	8	90	113	6	8011578941123	5,95
1531.100	10	90	114	6	8011578941147	5,95

1531A CHIAVE A BUSSOLA 1/2" ESAGONO
 SOCKET 1/2" HEXAGON



1/2"

Art. No.	Ø	L	h	h	Barcode	€
1531.205	5	140	141	6	8011578944964	8,80
1531.206	6	140	141	6	8011578944988	8,80
1531.208	8	140	144	6	8011578945008	8,80
1531.210	10	140	147	6	8011578945022	8,80

1532 CHIAVE A BUSSOLA 1/2" ESAGONO SFERICO
 SOCKET 1/2" HEXAGON BALL POINT



1/2"

Art. No.	Ø	L	h	h	Barcode	€
1532.050	5	90	107	6	8011578945046	7,35
1532.060	6	90	108	6	8011578945060	7,35
1532.080	8	90	111	6	8011578945084	7,35

1532Z SERIE 10 BUSS. ESAG. LUNGHE 1/2" - binario
 SET 10 SOCKETS HEX. DEEP 1/2" - holding bar



1/2"

Contenuto-content:

Art. No.	Ø	L	h	h	Barcode	€
1531.050	5	90	108	6	8011578941086	
1531.060	6	90	110	6	8011578941109	
1531.080	8	90	113	6	8011578941123	
1531.100	10	90	114	6	8011578941147	
1531.205	5	140	141	6	8011578944964	
1531.206	6	140	141	6	8011578944988	
1531.208	8	140	144	6	8011578945008	
1531.210	10	140	147	6	8011578945022	
1532.060	6	90	108	6	8011578945060	
1532.080	8	90	111	6	8011578945084	
1532.990			1260		8011578945107	79,85

1534

CHIAVE A BUSSOLA 1/2" - torx
 SOCKET 1/2" - torx

1/2"



Icona	Modello	Lunghezza	Spessore	Quantità	Barcode	Prezzo	
	1534.200	TX 20	56	81	6	8011578938024	5,95
	1534.250	TX 25	56	82	6	8011578938048	5,95
	1534.270	TX 27	56	82	6	8011578938062	5,95
	1534.300	TX 30	56	82	6	8011578938086	5,95
	1534.400	TX 40	56	68	6	8011578938109	5,95
	1534.450	TX 45	56	84	6	8011578938123	5,95
	1534.500	TX 50	56	84	6	8011578938147	5,95

1534T

CHIAVE A BUSSOLA 1/2" TX
 SOCKET 1/2" TORX

1/2"



Icona	Modello	Modello	Lunghezza	Spessore	Quantità	Barcode	Prezzo
	1534.840	TX 40	90	109	6	8011578945145	7,35
	1534.845	TX 45	90	110	6	8011578945169	7,35
	1534.850	TX 50	90	110	6	8011578945183	7,35
	1534.855	TX 55	90	112	6	8011578945206	7,35
	1534.860	TX 60	90	131	6	8011578945220	8,70
	1534.870	TX 70	90	152	6	8011578945244	9,85

1534A

SERIE 7 BUS. TX 1/2" - binario
 SET 7 SOCK. TORX 1/2" - hold. bar

1/2"



Contenuto-content:

1534.200 1534.270 1534.400 1534.500
 1534.250 1534.300 1534.450

Icona	Modello	Quantità	Barcode	Prezzo
	1534.797	496	8011578945121	46,40

1534Z

CHIAVE A BUSSOLA 1/2" TX
 SOCKET 1/2" TORX

1/2"



Icona	Modello	Modello	Lunghezza	Spessore	Quantità	Barcode	Prezzo
	1534.940	TX 40	140	142	6	8011578945268	9,05
	1534.945	TX 45	140	142	6	8011578945282	9,05
	1534.950	TX 50	140	143	6	8011578945305	9,05
	1534.955	TX 55	140	145	6	8011578945329	9,05

1534TZ

SERIE 10 BUSSOLE TORX LUNGHE 1/2" - binario
 SET 10 TORX SOCKETS - DEEP 1/2" - holding bar

1/2"

Contenuto-content:

1534.840 1534.850 1534.860 1534.940 1534.950
 1534.845 1534.855 1534.870 1534.945 1534.955

Icona	Modello	Quantità	Barcode	Prezzo
	1534.990	1328	8011578945343	88,90



1535

CHIAVE A BUSSOLA 1/2" TORX E FEMMINA
 SOCKET 1/2" TORX AND FEMALE

Icona	Modello	Lunghezza	Spessore	Quantità	Barcode	Prezzo			
	1535.100	E 10	38	13,5	22	50	6	8011578940942	3,75
	1535.120	E 12	38	15,0	22	50	6	8011578940966	3,75
	1535.140	E 14	38	17,0	22	52	6	8011578940980	3,75
	1535.160	E 16	38	19,0	22	57	6	8011578941000	3,75
	1535.180	E 18	38	20,0	22	57	6	8011578941024	3,75
	1535.200	E 20	38	22,0	24	72	6	8011578941048	4,50
	1535.240	E 24	38	24,0	28	98	6	8011578941062	5,20

1/2"



1535Z SERIE 7 CHIAVI A BUS. TORX 1/2" - binario
 SET 7 TORX SOCKETS 1/2" - holding bar



1/2"

Contenuto-content:







1535.100 1535.140 1535.180 1535.240
 1535.120 1535.160 1535.200

 **1535.907**  472  8011578945367  **33,20**

1538 CHIAVE A BUSSOLA 1/2" RIBE
 SOCKET 1/2" RIBE









1/2"

						€
1538.060	6	55	84	6	8011578945503	5,15
1538.070	7	55	85	6	8011578945527	5,15
1538.080	8	55	85	6	8011578945541	5,15
1538.100	10	55	88	6	8011578945565	5,15
1538.120	12	55	98	6	8011578945589	5,95

1537 CHIAVE A BUSSOLA 1/2" XZN SPLINE
 SOCKET 1/2" XZN SPLINE



1/2"

						€
1537.040	M 4	55	83	6	8011578945381	5,15
1537.050	M 5	55	84	6	8011578945404	5,15
1537.060	M 6	55	85	6	8011578945428	5,15
1537.080	M 8	55	86	6	8011578945442	5,15
1537.100	M 10	55	88	6	8011578945466	5,15
1537.120	M 12	55	98	6	8011578945480	5,80

1538Z SERIE 10 BUSSOLE XZN RIBE 1/2" - binario
 SET 10 XZN RIBE SOCKETS 1/2" - holding bar



1/2"

Contenuto-content:

1537.040 1537.060 1537.100 1538.060 1538.080
 1537.050 1537.080 1537.120 1538.070 1538.100

 **1538.797**  895  8011578945602  **56,90**

1542 SERIE 12 CHIAVI A BUSSOLA 1/2" + CRICCHETTO + PROLUNGA - mm 10 ÷ 24
 SET 12 SOCKETS 1/2" + RATCHET + EXTENSION - mm 10 ÷ 24



Contenuto - content:

1500.100
 1500.110
 1500.120
 1500.130
 1500.140
 1500.150
 1500.170
 1500.190
 1500.220
 1500.240
 1506.010
 1508.125

 **1542.010**  Pz. 12  1580  8011578963163  **56,00**

1545

CASSETTA 25 BUSSOLE E ACCESSORI 1/2" - mm 8 ÷ 32 - metallo
METAL BOX 25 SOCKETS AND ACCESSORIES 1/2" - mm 8 ÷ 32 - metal

1/2"

- Contenuto - content:
- 1500.080 mm 8
 - 1500.090 mm 9
 - 1500.100 mm 10
 - 1500.110 mm 11
 - 1500.120 mm 12
 - 1500.130 mm 13
 - 1500.140 mm 14
 - 1500.150 mm 15
 - 1500.160 mm 16
 - 1500.170 mm 17
 - 1500.180 mm 18
 - 1500.190 mm 19
 - 1500.210 mm 21
 - 1500.220 mm 22
 - 1500.240 mm 24
 - 1500.270 mm 27
 - 1500.300 mm 30
 - 1500.320 mm 32
 - 1505.010 254
 - 1508.125 125
 - 1508.250 250
 - 1510.010 250
 - 1512.010
 - 1527.160 mm 16
 - 1527.210 mm 21



 1545.010 355 x 190 x 50

 5100

 8011578003722

€ 153,70

1545.810 355 x 190 x 50 poligonali-bihex 5100 8011578970543 153,70

1545.910 355 x 190 x 50 pollici-inch 5100 8011578970482 185,50

1548

VALIGETTA 22 BUSSOLE E ACCESSORI 1/2" - mm 10 ÷ 32 - plastica
BLOW CASE 22 SOCKETS AND ACCESSORIES 1/2" - mm 10 ÷ 32 - plastic

1/2"

- Contenuto-content:
- 1500.100 mm 10
 - 1500.110 mm 11
 - 1500.120 mm 12
 - 1500.130 mm 13
 - 1500.140 mm 14
 - 1500.150 mm 15
 - 1500.160 mm 16
 - 1500.170 mm 17
 - 1500.180 mm 18
 - 1500.190 mm 19
 - 1500.220 mm 22
 - 1500.240 mm 24
 - 1500.270 mm 27
 - 1500.300 mm 30
 - 1500.320 mm 32
 - 1505.210
 - 1508.125
 - 1508.250
 - 1512.010
 - 1510.910
 - 1527.160 mm 16
 - 1527.210 mm 21



 1548.010 320 x 290 x 70

 3800

 8011578003746

€ 99,00



1555 VALIGETTA 94 BUSSOLE E ACCESSORI 1/4" - 1/2" - plastica
 BLOW CASE 94 SOCKETS AND ACCESSORIES 1/4" - 1/2" - plastic

Contenuto - content:

1400.040	1436.030	1500.200	0251.400
1400.045	1436.040	1500.210	0253.400
1400.050	1436.050	1500.220	0253.450
1400.055	1436.060	1500.230	0253.500
1400.060	1430.400	1500.240	0253.550
1400.070	1430.550	1500.270	0345.015
1400.080	1430.600	1500.300	0345.020
1400.090	1430.700	1500.320	0345.025
1400.100	1432.100	1502.140	1527.160
1400.110	1432.200	1502.150	1527.210
1400.120	1434.100	1502.170	
1400.130	1434.200	1502.190	
1400.140	1438.080	1505.210	
1402.060	1438.100	1508.125	
1402.070	1438.150	1508.250	
1402.080	1438.200	1512.010	
1402.090	1438.250	1510.010	
1402.100	1438.300	1520.010	
1402.110	1500.100	0263.080	
1402.120	1500.110	0263.100	
1402.130	1500.120	0263.120	
1405.210	1500.130	0263.140	
1408.075	1500.140	0249.080	
1408.150	1500.150	0249.100	
1408.000	1500.160	0249.120	
1414.010	1500.170	0250.300	
1410.010	1500.180	0250.400	
1412.010	1500.190	0251.300	

1/4" 1/2" **Pro**
 INDUSTRIAL



1/4" mm 4 ÷ 14
 1/2" mm 10 ÷ 32

 **1555.010** 380 x 320 x 80  5650  8011578003807  **179,00**

1557 VALIGETTA 88 BUSOLE - CHIAVI COMBinate - CHIAVI MASCHIO - plastica
 BLOW CASE 88 SOCKETS - COMBINATION WRENCHES - HEX KEYS - plastic

Contenuto - content:



0350.020	1400.130	1500.150	0251.400
0350.025	1400.140	1500.160	0253.400
0350.030	1405.010	1500.170	0253.450
0350.040	1408.075	1500.180	0253.500
0350.050	1408.150	1500.190	0253.550
0350.060	1408.000	1500.200	1527.160
1030.080	1414.010	1500.220	1527.210
1030.100	1410.010	1500.240	
1030.110	1412.010	1500.270	
1030.120	1436.300	1500.300	
1030.130	1436.400	1500.320	
1030.140	1436.500	1505.010	
1030.150	1436.600	1508.125	
1030.170	1430.400	1508.250	
1030.190	1430.500	1512.010	
1030.220	1430.600	1510.010	
1400.040	1432.100	1520.010	
1400.045	1432.200	0263.080	
1400.050	1434.100	0263.100	
1400.055	1434.200	0263.120	
1400.060	1438.080	0263.140	
1400.070	1438.100	0249.080	
1400.080	1438.150	0249.100	
1400.090	1438.200	0249.120	
1400.100	1438.250	0250.300	
1400.110	1438.300	0250.400	
1400.120	1500.140	0251.300	

1/4" 1/2"



1/4" mm 4 ÷ 14
 1/2" mm 14 ÷ 32
CHIAVI COMBinate mm 8 ÷ 22
COMBINATION WRENCHES mm 8 ÷ 22



 **1557.010** 380 x 320 x 80  6150  8011578966003  **210,00**

1560
VALIGETTA 56 UTENSILI VARI: CHIAVI - CACCIAVITI - PINZE - BUSSOLE - plastica
BLOW CASE 56 TOOLS: WRENCHES - SCREWDRIVERS - PLIERS - SOCKETS - plastic
1/4" 1/2"

1/4" - 1/2" mm 8 ÷ 27
CHIAVI COMBINATE mm 8 ÷ 17
COMBINATION WRENCHES mm 8 ÷ 17

Contenuto - content:

0170.610	0253.200
0170.503	0253.250
0172.610	0253.270
0172.615	0253.300
0172.103	0253.400
0377.040	1400.080
0440.018	1400.090
0490.024	1400.100
1030.080	1400.110
1030.100	1400.120
1030.120	1400.130
1030.130	1420.010
1030.150	1414.010
1030.170	1500.100
0345.015	1500.110
0345.020	1500.120
0345.025	1500.130
0345.030	1500.150
0345.040	1500.170
0250.100	1500.190
0250.200	1500.220
0250.300	1500.240
0249.300	1500.270
0249.400	1505.010
0249.500	1508.125
0249.600	1512.010
0253.100	1527.160
0253.150	1527.210

1560.010 380 x 320 x 80

5300



80115781000004

**179,80****1565**
VALIGETTA 30 BUSSOLE 1/2" ESAGONO MASCHIO
BLOW CASE 30 SOCKETS 1/2" HEX MALE

Contenuto - content:

1530:	esagono - hex mm 5 - 6 - 7 - 8 - 10 - 12 - 14 - 19 lunghezza - lenght mm 55
1531:	esagono - hex mm 5 - 6 - 7 - 8 - 9 - 10 - 12 - 13 lunghezza - lenght mm 100
1531A:	esagono - hex mm 5 - 6 - 7 - 8 - 10 - 12 - 14 lunghezza - lenght mm 140
1531A:	esagono - hex mm 5 - 6 - 7 - 8 - 10 - 12 lunghezza - lenght mm 200

**1565.010**

4870



8011578972486

**160,00**

1570 ESPOSITORE 180 CHIAVI BUSSOLA 1/2" E ACCESSORI 1/4" - 3/8" - 1/2" - metallo
 DISPLAY 180 SOCKETS 1/2" AND ACCESSORIES 1/4" - 3/8" - 1/2" - metal

1/4" 3/8" 1/2"







Contenuto - content:

1405.010	Nr. 2	1500.170	17	Nr. 6	
1408.075	Nr. 2	1500.180	18	Nr. 6	
1408.150	Nr. 2	1500.190	19	Nr. 6	
1410.010	Nr. 2	1500.200	20	Nr. 6	
1412.010	Nr. 2	1500.210	21	Nr. 6	
1414.010	Nr. 2	1500.220	22	Nr. 6	
1425.010	Nr. 2	1500.230	23	Nr. 3	
1455.010	Nr. 2	1500.240	24	Nr. 3	
1458.075	75	Nr. 2	1500.250	25	Nr. 3
1458.150	150	Nr. 2	1500.260	26	Nr. 3
1460.010	Nr. 2	1500.270	27	Nr. 3	
1462.010	Nr. 2	1500.280	28	Nr. 3	
1475.010	Nr. 2	1500.300	30	Nr. 3	
1475.020	Nr. 2	1500.320	32	Nr. 3	
1500.080	8	Nr. 6	1502.100	10	Nr. 3
1500.090	9	Nr. 6	1502.130	13	Nr. 3
1500.100	10	Nr. 6	1502.170	17	Nr. 3
1500.110	11	Nr. 6	1505.010		Nr. 2
1500.120	12	Nr. 6	1508.125		Nr. 2
1500.130	13	Nr. 6	1508.250		Nr. 2
1500.140	14	Nr. 6	1510.010		Nr. 2
1500.150	15	Nr. 6	1512.010		Nr. 2
1500.160	16	Nr. 6	1525.010		Nr. 2



	↔ L ↔			€
1570.015	490 x 400 x 230	14500	8011578985448	876,75 new
1570.215	vuoto - empty	5000	8011578985462	55,00 new

1600 CHIAVE A BUSSOLA 3/4" - ESAGONALE
 SOCKET 3/4" - HEXAGON

							€
1600.220	22	51	32 36	212	2	8011578938161	8,15
1600.230	23	51	32 36	216	2	8011578938185	8,15
1600.240	24	50	34 36	218	2	8011578938208	8,55
1600.260	26	53	36 38	262	2	8011578938222	8,70
1600.270	27	53	36 38	224	2	8011578938246	8,70
1600.280	28	53	38 40	265	2	8011578938260	8,70
1600.300	30	54	38 42	282	2	8011578938284	9,35
1600.320	32	56	38 44	300	2	8011578938307	9,95
1600.330	33	56	38 46	333	2	8011578938321	12,00
1600.340	34	56	38 46	316	2	8011578938345	12,00
1600.360	36	58	42 50	424	2	8011578938369	13,40
1600.380	38	58	42 50	500	2	8011578938383	13,40
1600.410	41	64	45 56	574	2	8011578938406	15,75
1600.460	46	71	48 62	702	2	8011578938420	15,95
1600.500	50	73	48 68	794	2	8011578938444	18,05
1600.550	55	72	48 68	918	2	8011578938468	28,20
1600.600	60	75	49 74	1125	2	8011578938482	33,50

3/4"



1605 CRICCHETTO REVERSIBILE 3/4" - sgancio rapido
 RATCHET 3/4" - REVERSIBLE - quick release

3/4"



	↔ L ↔				€
1605.010	500	1936	1	8011578938505	84,60

1608
PROLUNGA 3/4"
EXTENSION BAR 3/4"

Icona	Quantità	Imballaggio	Barcode	Prezzo
	100	800	8011578938529	12,75
	200	808	8011578938543	17,30
	400	1522	8011578938567	28,75

3/4"**1610**
LEVA A "T" 3/4"
SLIDING "T" BAR 3/4"

Icona	Quantità	Imballaggio	Barcode	Prezzo
	460	1328	8011578942762	32,55

3/4"**1612**
SNODO CARDANICO 3/4"
UNIVERSAL JOINT 3/4"

Icona	Quantità	Imballaggio	Barcode	Prezzo
	108	546	8011578938581	34,55

3/4"**1625**
ADATTATORE 3/4" F - 1/2" M
ADAPTERS 3/4" F - 1/2" M

Icona	Quantità	Imballaggio	Barcode	Prezzo
	200	2	8011578938604	10,75

3/4" 1/2"**1640**
CASSETTA 14 BUSSOLE 3/4" - mm 22 ÷ 50 - metallo
METAL BOX 14 SOCKETS 3/4" - mm 22 ÷ 50 - metal
**3/4"**

Contenuto-content:

1600.220 22	1600.320 32	1600.460 46	1608.100 100
1600.240 24	1600.360 36	1600.500 50	1608.200 200
1600.270 27	1600.380 38	1605.010	
1600.300 30	1600.410 41	1610.010	

Icona	Quantità	Imballaggio	Barcode	Prezzo
	550 x 190 x 70	11900	8011578902216	317,00

1640
CASSETTA 21 BUSSOLE 3/4" - mm 19 ÷ 50
BLOW CASE 21 SOCKET 3/4 - mm 19 ÷ 50
**3/4"**

Contenuto-content:

1600.190 19	1600.360 36
1600.210 21	1600.380 38
1600.220 22	1600.410 41
1600.230 23	1600.460 46
1600.240 24	1600.500 50
1600.260 26	1608.100 100
1600.270 27	1608.200 200
1600.290 29	1608.400 400
1600.300 30	1605.010
1600.320 32	1610.010
1600.350 35	

Icona	Quantità	Imballaggio	Barcode	Prezzo
	13600		8011578972462	349,65

1642 CHIAVE A BUSSOLA 1" - ESAGONALE
 SOCKET 1" - HEXAGON

Model	Size	Length	Width	Height	Weight	Code	Barcode	Price
1642.360	36	65	46	51	504	1	8011578944568	19,70
1642.410	41	70	45	57	624	1	8011578944582	21,35
1642.460	46	75	50	65	922	1	8011578944605	23,60
1642.500	50	75	56	70	1100	1	8011578944629	26,45
1642.550	55	80	56	76	1354	1	8011578944643	34,85
1642.600	60	88	57	82	1512	1	8011578944667	39,35
1642.650	65	88	56	88	1730	1	8011578944681	47,20
1642.700	70	94	68	94	2212	1	8011578944704	55,10
1642.750	75	98	68	100	2534	1	8011578944728	63,50
1642.800	80	104	68	105	2734	1	8011578944742	74,20

1"



1645 CRICCHETTO 1" RATCHET 1"

Model	Length	Weight	Code	Barcode	Price
1645.010	665	4374	1	8011578944766	161,80

1"



1646 LEVA A "T" 1" SLIDING "T" BAR 1"

Model	Length	Weight	Code	Barcode	Price
1646.010	565	2754	1	8011578944780	72,50

1"



1647 PROLUNGA 1" EXTENSION BAR 1"

Model	Length	Weight	Code	Barcode	Price
1647.200	200	1310	1	8011578944803	39,35
1647.400	400	2250	1	8011578944827	59,60

1"



1648 ADATTATORE 1" F - 3/4" M ADAPTER 1" F - 3/4" M

Model	Description	Weight	Code	Barcode	Price
1648.010	F 1"-M 3/4" riduttore/reduction	404	1	8011578944841	15,75

1" 3/4"



1649 CASSETTA 15 BUSSOLE E ACCESSORI 1"- metallo METAL CASE 15 SOCKETS AND ACCES. 1"- metal

Model	Dimensions	Weight	Code	Barcode	Price
1649.010	660 x 205 x 100	31816	1	8011578944865	799,00

Contenuto-content:

- 1642.360 1642.750
- 1642.410 1642.800
- 1642.460 1645.010
- 1642.500 1646.010
- 1642.550 1647.200
- 1642.600 1647.400
- 1642.650 1648.010
- 1642.700

1"



1654 RACCORDO DA 1/2" F - 3/4" M
 ADAPTER FROM 1/2" F - 3/4" M

1/2" 3/4"



					€
1654.910	58	324	2	8011578985721	11,65 new

1655 SERIE 3 CHIAVI A BUSSOLA 1/2" LUNGHE MACCHINA
 SET 3 SOCKET 1/2" - DEEP IMPACT

1/2"









					€
1655.010	mm 17-19-21	840	1	8011578655006	43,90





1656 CHIAVI A BUSSOLA 1/2" LUNGHE MACCHINA CON PROTEZIONE PLASTICA PER RUOTE
 SOCKET 1/2" - DEEP IMPACT

1/2"



						€
1656.170	17	85	200	2	8011578971427	11,15
1656.190	19	85	200	2	8011578971441	11,15
1656.210	21	85	200	2	8011578971465	11,15

1658 SPINA
 PIN

					€
1658.010	20 1650 8÷13 - 1652 10÷13	2,5	1	8011578948801	0,95
1658.020	25 1650 14÷32 - 1652 14÷27	3	1	8011578948825	0,95







1659 ANELLO
 RING

					€
1659.010	20	2	1	8011578948849	0,65
1659.020	26	2	1	8011578948863	0,75

1664 CHIAVE A BUSSOLA 3/4" - MACCHINA IMPACT
 SOCKET 3/4" - IMPACT













3/4"



						€
1664.170	17	50	322	2	8011578965341	14,85
1664.190	19	50	332	2	8011578965365	14,85
1664.210	21	50	345	2	8011578965389	14,85
1664.220	22	50	355	2	8011578965402	14,85
1664.230	23	50	358	2	8011578965426	14,85
1664.240	24	50	355	2	8011578965440	14,85
1664.260	26	50	375	2	8011578965464	14,85
1664.270	27	50	350	2	8011578965488	14,85
1664.300	30	53	408	2	8011578965501	16,85
1664.320	32	53	434	2	8011578965525	18,80
1664.330	33	55	464	2	8011578965549	19,30
1664.360	36	55	490	2	8011578965563	20,65
1664.380	38	58	525	2	8011578965587	21,40
1664.410	41	58	580	2	8011578965600	23,75
1664.460	46	62	738	2	8011578965624	30,55

1665 CHIAVE A BUSSOLA 3/4" - MACCHINA IMPACT LUNGHE
 SOCKET 3/4" - DEEP IMPACT

3/4"

Icona	Modello	Spessore	Quantità	Barcode	Prezzo
	1665.170	17	90	510 2 8011578962548	26,15
	1665.190	19	90	518 2 8011578962562	26,15
	1665.210	21	90	518 2 8011578984908	26,15 new
	1665.220	22	90	566 2 8011578962586	26,15
	1665.240	24	90	590 2 8011578962609	26,15
	1665.250	25	90	620 2 8011578985882	26,15 new
	1665.270	27	90	648 2 8011578962623	26,15
	1665.300	30	90	698 2 8011578962647	28,00
	1665.320	32	90	768 2 8011578962661	29,55
	1665.330	33	90	736 2 8011578962685	30,40
	1665.360	36	90	746 2 8011578962708	32,90
	1665.410	41	90	920 2 8011578962722	38,30
	1665.460	46	90	998 2 8011578962746	44,65



1666 PROLUNGA 3/4" - MACCHINA IMPACT
 EXTENSION 3/4" - IMPACT

3/4"

Icona	Modello	Spessore	Quantità	Barcode	Prezzo
	1666.010	100	586	2 8011578962760	26,25





1667 SNODO 3/4" - MACCHINA IMPACT
 UNIVERSAL JOIN 3/4" - IMPACT

3/4"

Icona	Modello	Spessore	Quantità	Barcode	Prezzo
	1667.010	90	492	2 8011578962784	49,70



1668 RACCORDO
 ADAPTER FROM

Icona	Modello	Spessore	Quantità	Barcode	Prezzo
	1668.010	3/4"-1/2"	324	2 8011578962807	16,30
	1668.020	3/4"-1"	400	2 8011578985769	18,00 new



1669 SPINA 3/4"
 PIN 3/4"

Icona	Modello	Spessore	Quantità	Barcode	Prezzo
	1669.010	2,5	1	8011578962821	1,25



1669 ANELLO 3/4"
 RING 3/4"

Icona	Modello	Spessore	Quantità	Barcode	Prezzo
	1669.050	2	1	8011578962845	1,00



1670 CHIAVE A BUSSOLA 1" - MACCHINA IMPACT
 SOCKET 1" - IMPACT

1"



Model	Length (mm)	Width (mm)	Weight (g)	Material	Barcode	Price (€)
1670.270	27	63	692	1	8011578985929	26,50 new
1670.320	32	63	692	1	8011578985967	26,50 new
1670.330	33	63	692	1	8011578986001	26,50 new
1670.360	36	63	692	1	8011578962869	26,50
1670.410	41	66	844	1	8011578962883	31,60
1670.460	46	70	1026	1	8011578962906	32,85
1670.500	50	70	1124	1	8011578962920	40,70
1670.550	55	83	1366	1	8011578962944	56,80
1670.600	60	86	1690	1	8011578962968	59,90
1670.650	65	85	1934	1	8011578962982	73,55

1671 PROLUNGA 1" - MACCHINA IMPACT
 EXTENSION 1" - IMPACT

1"



Model	Length (mm)	Weight (g)	Material	Barcode	Price (€)
1671.010	175	1414	1	8011578963002	48,35

1673 RACCORDO DA 1" F - 3/4" M
 ADAPTER FROM 1" F - 3/4" M

1" 3/4"



Model	Length (mm)	Weight (g)	Material	Barcode	Price (€)
1673.010	75	658	1	8011578963026	21,85

1674 SPINA 1"
 PIN 1"



Model	Quantity	Weight (g)	Material	Barcode	Price (€)
1674.010	2,5	1	1	8011578963088	1,15

1674 ANELLO 1"
 RING 1"



Model	Quantity	Weight (g)	Material	Barcode	Price (€)
1674.050	2	1	1	8011578963101	0,90

1700 CHIAVE DINAMOMETRICA ATTACCO 1/2"
 TORQUE WRENCH 1/2"

Quality
 GARANTIA
 GUARANTEE



1/2"



Model	Nm	L	W	Sp.	Barcode	Price
1700.110	20 - 110	370	1100	1	8011578948887	76,00
1700.210	42 - 210	450	1700	1	8011578948900	78,65
1700.350	70 - 350	630	2800	1	8011578948924	132,25

1702 CHIAVE DINAMOMETRICA REVERSIBILE SGANCIO RAPIDO LETTURA A FINESTRA - PROFESSIONALE
 TORQUE WRENCH REVERSIBLE - QUICK RELEASE SCALE READING WINDOW - PROFESSIONAL

Pro
 INDUSTRIAL

tolleranza - tolerance ± 3%
 45 denti - teeth



1/2"



1/2"



1/2"



3/8"



1/4"



Model	Nm	L	W	Sp.	Barcode	Price		
1702.025	5-25	1/4"	285	28	394	1	8011578965648	159,85
1702.050	10-50	3/8"	370	32	948	1	8011578965662	151,25
1702.100	20-100	1/2"	405	37	1020	1	8011578960247	162,30
1702.200	20-200	1/2"	500	37	1200	1	8011578960261	166,00
1702.300	60-300	1/2"	595	37	1330	1	8011578960308	193,00



1708 GONIOMETRO PER SERRAGGIO ANGOLARE 1/2" - 1/2"
 GONIOMETER ANGULAR TORQUE 1/2" - 1/2"



					
1708.010	1/2 - 1/2	152	1	8011578971489	22,35





1709 GONIOMETRO PER SERRAGGIO ANGOLARE 1/2" - 1/2" CON CALAMITA
 GONIOMETER ANGULAR TORQUE WITH MAGNETIC 1/2" - 1/2"



					
1709.010	1/2 - 1/2	246	1	8011578971502	45,90





1720 ESTRATTORE 2 GRIFFE SCORREVOLI AUTOBLOCCANTI
 PULLER 2 ARMS







	A x L				
1720.000	80x70	384	1	8011578974183	27,10
1720.001	90x100	770	1	8011578974206	38,85
1720.002	120x100	834	1	8011578974220	40,00
1720.003	170x150	2220	1	8011578974244	74,15
1720.004	220x150	2438	1	8011578974268	76,50

1720... PAIO GRIFFE RICAMBIO SCORREVOLI AUTOBLOCCANTI
 PAIR OF PULLER ARMS



	per - for				
1720.100	1720.000	333	1	8011578 974282	4,70
1720.102	1720.001 - 1720.002	360	1	8011578974305	9,45
1720.104	1720.003 - 1720.004	400	1	8011578974329	26,90

1720... VITI RICAMBIO
 SCREW

	per - for				
1720.300	1720.000	1	1	8011578974343	4,35
1720.302	1720.001 - 1720.002	1	1	8011578974367	4,95
1720.304	1720.003 - 1720.004	1	1	8011578974381	4,95

1723 ESTRATTORE 2 GRIFFE SCORREVOLI CON BULLONI
 PULLER 2 ARMS WITH BOLTS

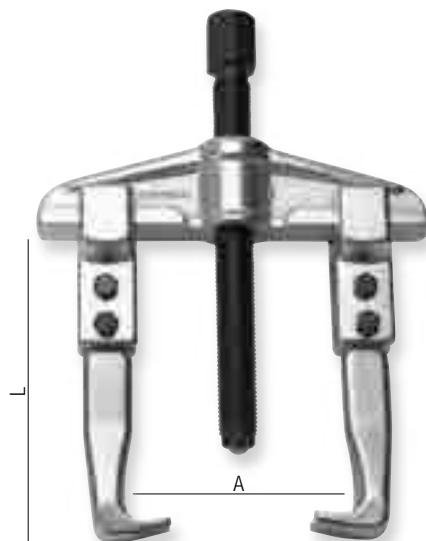

Icona	A x L	A min.	Icona	Icona	Icona	Icona	Icona	€
	90x100	25			81157811000004	1	8011578971069	38,85
	130x100	25				1	8011578971083	43,50
	160x150	50				1	8011578971106	77,65
	200x150	60				1	8011578971120	92,95

1723... PAIO GRIFFE RICAMBIO CON BULLONI
 PAIR OF PULLER ARMS WITH BOLTS



Icona	Icona	per - for	Icona	Icona	Icona	Icona	Icona	€
	100	1723.001-1723.002			81157811000004	1	8011578971526	22,35
	150	1723.003-1723.004				1	8011578971540	45,90

1723... PAIO GRIFFE LUNGHE RICAMBIO CON BULLONI
 PAIR OF LONG PULLER ARMS WITH BOLTS



Icona	Icona	per - for	Icona	Icona	Icona	Icona	Icona	€
	200	1723.001-1723.002			81157811000004	1	8011578971564	35,30
	300	1723.003-1723.004				1	8011578971588	62,40

1723... PAIO GRIFFE RICAMBIO CON BULLONI
 PAIR OF PULLER ARMS WITH BOLTS



Icona	Icona	Ex C	Icona	Icona	Icona	Icona	Icona	€
	100	3,6 x 14			81157811000004	1	8011578974749	35,30
	152	5 x 17				1	8011578976248	62,40



1725 ESTRATTORE AUTOSERRANTE 3/2 GRIFFE PER ESTERNI
 PULLER PILOT 3/2 EXTERNAL



 AxL
1725.010 23/130 x 140   1654 **1**  011578 000004  **188,25**

1726 ESTRATTORE AUTOSERRANTE 3/2 GRIFFE PER INTERNI
 PULLER PILOT 3/2 INTERNAL



 AxL
1726.010 70/130 x 140   1361 **1**  011578 000004  **188,25**

1730 ESTRATTORE REVERSIBILE 2 GRIFFE
 REVERSIBLE 2 JAWS PULLER

EX 1340



 AxL
1730.001 90 x 115   1000 **1**  011578 000004  **28,95**
1730.002 140 x 160   2100 **1**  011578 000004  **51,65**

1731 ESTRATTORE REVERSIBILE 3 GRIFFE
 REVERSIBLE 3 JAWS PULLER

EX 1341

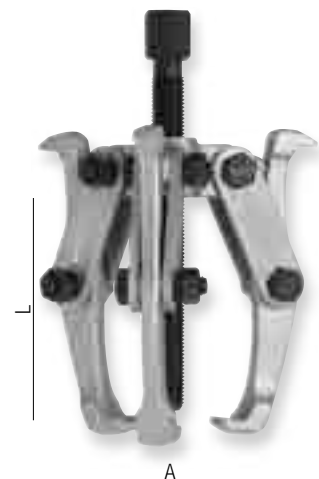

	A x L				€
1731.001	90 x 110	1000	1	8011578974480	38,45
1731.002	140 x 160	2900	1	8011578974503	79,40

1738 ESTRATTORE PER SNODI SFERICI
 PULLER BALL JOIN

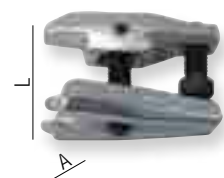

	A x L				€
1738.010	18/22 x 50	750	1	8011578974527	19,45

1739 ESTRATTORE PER SNODI SFERICI
 PULLER BALL JOIN



	A x L				€
1739.010	20/12 x 50	1190	1	8011578974541	37,65

1739 ESTRATTORE PER SNODI SFERICI
 PULLER BALL JOIN

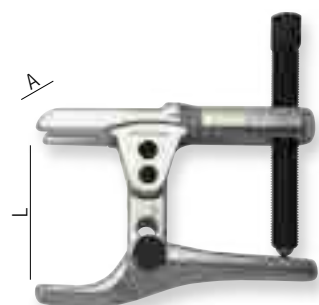

	A x L				€
1739.020	20/60 x 80	1440	1	8011578974565	48,25



1750 BUSTA AVVOLGIBILE 12 UTENSILI
 ROLLER BAG WITH 12 TOOLS



Contenuto-content:

- 0115.307 3 x 75
- 0115.612 6 x 125
- 0116.006 PH 0 x 60
- 0116.210 PH 2 x 100
- 0377.020 gr. 200
- 0495.024 240
- 1020.067 6 x 7
- 1020.089 8 x 9
- 1020.101 10 x 11
- 1020.123 12 x 13
- 1020.145 14 x 15
- 1020.167 16 x 17

	Pz.			€
1750.010	12	1280	8011578750008	68,20

1754 BUSTA AVVOLGIBILE 12 UTENSILI
 ROLLER BAG WITH 12 TOOLS



Contenuto-content:

- 0115.612 6 x 125
- 0116.210 PH 2 x 100
- 0380.020 gr. 200
- 0425.018 180
- 0456.016 160
- 0495.024 240
- 1020.067 6 x 7
- 1020.089 8 x 9
- 1020.101 10 x 11
- 1020.123 12 x 13
- 1020.145 14 x 15
- 1020.167 16 x 17

	Pz.			€
1754.010	12	1800	8011578754013	86,55

1756 TASCA 4 UTENSILI
 ENVELOPE 4 TOOLS



Contenuto-content:

- 0132.415
- 0135.108
- 0689.010
- 0440.918

	Pz.			€
1756.010	4	423	8011578969608	33,60

1756 TASCA 4 UTENSILI
 ENVELOPE 4 TOOLS



Contenuto-content:

- 0090.410
- 0092.110
- 0683.010
- 0710.018

	Pz.			€
1756.020	4	499	8011578969622	55,05

1756 TASCA UTENSILI
 ENVELOPE TOOLS



	Pz.			€
1756.110	vuota - empty	46	8011578969646	10,00

1759.010 BORSA TESSUTO 39 UTENSILI

BAG WITH 39 TOOLS

- porta notebook e documenti
- tracolla
- 1 pannello rimovibile
- notebook and documents holder
- shoulder strap
- 1 removable panel



Contenuto-content:

0050.307	3,0 x 75	1020.089	8 x 9
0050.512	5,5 x 125	1020.101	10 x 11
0050.612	6,5 x 125	1020.123	12 x 13
0051.412	4,0 x 125	1020.145	14 x 15
0052.006	PH 0 x 60 - 3	1020.167	16 x 17
0052.108	PH 1 x 80 - 4,5	0412.916	mm 165
0052.210	PH 2 x 100 - 6	0440.918	mm 180
0225.410	4 x 100	0466.916	mm 170
0347.090		0490.004	
0362.090		0683.010	
1020.067	6 x 7		

    €

1759.010 440 x 220 x 320 **new** 4800 8011578985806 **252,20**

1759.110 BORSA TESSUTO - vuota

FABRIC BAG - empty

- porta notebook e documenti
- tracolla
- 1 pannello rimovibile
- notebook and documents holder
- shoulder strap
- 1 removable panel



    €

1759.110 440 x 220 x 320 **new** 2400 8011578985820 **117,65**

1762 CASSETTA PORTAUTENSILI 39 UTENSILI - plastica

TOOL BOX 39 TOOLS - plastic

- con interno asportabile
- e portaminuterie
- with removable interior and
- tray for small parts



Contenuto - content:

0050.307	1030.080
0050.410	1030.090
0050.612	1030.100
0052.108	1030.110
0052.210	1030.130
0236.010	1030.140
0440.918	1030.170
0412.916	1030.190
0490.024	1844.010
0347.090	1820.030
0377.030	
0689.010	

    €

1762.010 470 x 260 x 220 3900 8011578931766 **164,00**

1762 CASSETTA PORTAUTENSILI - plastica

TOOL BOX - plastic

- con interno asportabile
- e portaminuterie
- with removable interior and
- tray for small parts



470 x 260 x 220

    €

1762.210 vuota - empty 2100 8011578931773 **28,10**



1763 CASSETTA METALLO 3 SCOMPARTI - vuota
 METAL TOOL BOX WITH 3 TRAY - empty



450 x 200 x 160 mm

 **1763.015** vuota - empty  3600  8011578976521  **56,00** new

1764 CASSETTA MET. 5 SCOMPARTI - LUNGA vuota
 METAL TOOL BOX WITH 5 TRAY - LONG empty



550 x 215 x 225

 **1764.015** vuota - empty  5700  8011578934361  **66,90**

1764 CASSETTA METALLO 33 UTENSILI 5 SCOMPARTI
 METAL TOOL BOX WITH 33 TOOLS 5 TRAY



Contenuto - content:

- 0050.307 1020.067
- 0050.410 1020.089
- 0050.612 1020.101
- 0052.108 1020.123
- 0052.210 1020.145
- 0347.090 1020.167
- 0412.916 1020.189
- 0440.918 1020.202
- 0490.024
- 0377.030
- 0620.010
- 0683.010

 **1764.010**  550 x 215 x 225  8750  8011578764005  **215,10**

1765 BORSA 28 UTENSILI PER INSTALLATORE
 BAG WITH 28 TOOLS FOR INSTALLER



Contenuto - content:

- 1844.010
- 0232.306
- 0050.307
- 0050.410
- 0050.612
- 0052.108
- 0052.210
- 0347.090
- 0683.010
- 1820.030
- 1020.067
- 1020.089
- 1020.101
- 1020.123
- 1020.167
- 0463.916
- 0440.918
- 0412.916
- 0495.024
- 0377.020
- 1765.110

    €
1765.010 430 x 290 x 190 6070 8011578931780 **396,85**

1766 VALIGIA 41 UTENSILI PER ASSISTENZA - 2 pann.
 SUITCASE WITH 41 TOOLS - 2 panels



Contenuto - content:

- 0050.307 0528.010
- 0050.410 0525.010
- 0050.612 0527.010
- 0052.108 0524.010
- 0052.112 0526.010
- 0052.210 0232.306
- 1070.015 0162.105
- 1844.010 0162.207
- 0683.010 0162.310
- 0347.090 0163.005
- 0412.916 0163.006
- 0463.916 1766.110
- 0440.918
- 0377.020
- 0558.010
- 0532.110
- 0532.210
- 0540.110
- 0540.210
- 0541.210
- 0520.010
- 0522.010

    €
1766.010 490 x 370 x 190 8000 8011578931872 **370,60**

1765 BORSA PER INSTALLATORE
 BAG FOR INSTALLER



430 x 290 x 190

   €
1765.110 vuota - empty 3400 8011578949822 **275,00**

1766 VALIGIA ABS ANTIURTO - 2 pann.
 ABS SUITCASE - 2 panels



490 x 370 x 190

   €
1766.110 vuota - empty 5500 8011578931841 **186,05**



1766 VALIGIA TROLLEY 41 UTENSILI PER ASS. - 2 pann.
 ABS TROLLEY SUITCASE WITH 41 TOOLS - 2 pan.



Contenuto - content:

- | | | |
|----------|----------|----------|
| 0050.307 | 0440.918 | 0527.010 |
| 0050.410 | 0377.020 | 0524.010 |
| 0050.612 | 0558.010 | 0526.010 |
| 0052.108 | 0532.110 | 0232.306 |
| 0052.112 | 0532.210 | 0162.105 |
| 0052.210 | 0540.110 | 0162.207 |
| 1070.015 | 0540.210 | 0162.310 |
| 1844.010 | 0541.210 | 0163.005 |
| 0683.010 | 0520.010 | 0163.006 |
| 0347.090 | 0522.010 | 1766.310 |
| 0412.916 | 0528.010 | |
| 0463.916 | 0525.010 | |

    
1766.210 490 x 370 x 190 8000 8011578975142 **433,55**

1766 VALIGIA TROLLEY CON RUOTE ABS - 2 pann.
 ABS TROLLEY SUITCASE WITH WHEELS - 2 panels



   
1766.310 vuota - empty 5500 8011578970529 **249,00**

1767 VALIGIA 38 UTENSILI PER ASSISTENZA - 2 pann.
 SUITCASE WITH 38 TOOLS - 2 panels



Contenuto - content:

- | | |
|----------|----------|
| 0050.307 | 1030.130 |
| 0050.410 | 1030.150 |
| 0050.512 | 1030.170 |
| 0050.612 | 1030.190 |
| 0052.006 | 1030.220 |
| 0052.108 | 1820.030 |
| 0052.210 | 1844.010 |
| 0232.306 | 1767.110 |
| 0347.090 | |
| 0377.030 | |
| 0412.916 | |
| 0417.022 | |
| 0440.918 | |
| 0463.916 | |
| 0490.024 | |
| 0689.010 | |
| 1030.060 | |
| 1030.070 | |
| 1030.080 | |
| 1030.090 | |
| 1030.100 | |
| 1030.110 | |
| 1030.120 | |

    
1767.010 490 x 390 x 190 12100 8011578969189 **344,15**

1767 VALIGIA ALLUMINIO ANTIURTO - 2 pann.
 ALUMINIUM SUITCASE - 2 panels



490 x 390 x 190

   
1767.110 vuota - empty 5600 8011578965846 **173,00**

1770 BORSA 13 UTENSILI ISOLATI 1000 volt VDE
 BAG 13 INSULATED TOOLS 1000 volt VDE



Contenuto-content:

0090.310 0090.615 0232.306 0710.018 0716.016
 0090.410 0092.007 0377.020 0092.110 1765.110
 0090.512 0092.210 0683.010 0712.020

    €
1770.010 430 x 290 x 190 5080 8011578770006 **404,40**

1774 VALIGIA 13 UTENSILI ISOLATI 1000 volt VDE
 SUITCASE 13 INSULATED TOOLS 1000 volt VDE



Contenuto-content:

0090.310 0092.110 0710.018
 0090.410 0092.210 0712.020
 0090.512 0232.306 0716.016
 0090.615 0377.020 1766.110
 0092.007 0683.010

    €
1774.010 490 x 370 x 190 7200 8011578774004 **315,45**

1778 BORSA 28 UTENSILI PER IDRAULICI
 BAG 28 TOOLS FOR HYDRAULIC



Contenuto - content:

0050.307
 0050.410
 0050.612
 0052.108
 0052.210
 0347.090
 0412.916
 0440.918
 0490.024
 0502.032
 0792.042
 0774.032
 1020.067
 1020.089
 1020.101
 1020.123
 1020.145
 1020.167
 1020.189
 1020.202

    €
1778.010 460 x 180 x 180 5650 8011578778002 **326,05**

1778 BORSA PER IDRAULICI
 BAG FOR HYDRAULIC



460 x 180 x 180

    €
1778.110 vuota - empty 1800 8011578778026 **148,40**



1803.210 CARRELLO 3 RIPIANI - vuoto
 TROLLEY 3 TRAYS - empty



- Ruote 100 mm - 2 ruote girevoli con freno
 Wheels 100 mm - 2 wheels with brake
- Carico statico totale 200 kg
 Total static load 200 kg
- Fornito smontato - dimensioni scatola 760 x 460 x 260
 Supplied unassembled - box dimensions 760 x 460 x 260

  **1803.210** 710 x 410 x 840  17800  8011578 000004  **226,20**

1805.210 CASSETTIERA PORTATILE - 6 CASSETTI - vuota
 PORTABLE CHEST OF DRAWER - 6 DRAWERS - empty



- 1 cassetto/drawer h 74
- 2 cassetti/drawers h 51
- 3 cassetti piccoli/small drawers h 51
- 1 vano superiore apribile/upper openable case h 74
- Guide telescopiche a sfera/Ball bearing sliders
- Serratura centralizzata/Lock
- Maniglie laterali per trasporto/Side handles for handling

  **1805.210** 660 x 320 x 380  24500  8011578 943707  **324,80**

1805.056 CASSETTIERA CON 56 UTENSILI - 4 moduli
 CHEST OF DRAWER WITH 56 TOOLS - 4 modules

Contenuto-content:
 1805.210
 1815.010
 1815.040
 1815.100
 1815.140



  **1805.056** 660 x 320 x 380  30500  8011578 949624  **742,40**

1815.010

1815.040

1815.100

1815.140

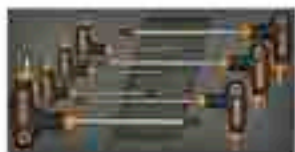
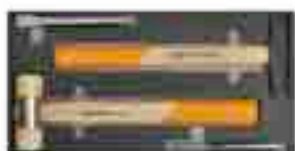

professionali

professionali

professionali



carrelli per utensili con moduli morbidi in spugna bicolore

- resistente a prodotti chimici
- bicolore per immediata identificazione utensili mancanti
- sagomatura precisa per ogni utensile
- moduli intercambiabili con altri tipi

trolleys for tools with soft sponge double colour modules

- chemical product resistant
- double-colour for missing tools identification
- precision profile for each tools
- interchangeable modules



1810.210

CARRELO 7 CASSETTI - piano di lavoro in gomma - vuoto TROLLEY 7 DRAWERS - rubber top - empty

piano di lavoro GOMMA
 RUBBER top

piano di lavoro in gomma
 RUBBER top

Pro
 INDUSTRIAL

CARICO STATICO
 TOTAL STATIC LOAD
 KG. 700



- 5 cassetti/drawers h 65 x 385 x 570
- 2 cassetti/drawers h 125 x 385 x 570
- Carico statico totale 700 kg
 Total static load 700 kg
- Guide telescopiche a sfera/Ball bearing sliders
- 2 ruote fisse - 2 ruote girevoli con freno
 2 wheels - 2 wheel with brake
- Serratura centralizzata/Lock
- Piano di lavoro in gomma/Rubber top mat

Icona	Descrizione	Quantità	Barcode	Prezzo
	1810.210 700 x 470 x 990	60000	8011578947866	€ 680,00
	1813.201 serratura/lock	52	8011578975302	€ 10,60
	1813.205 chiave grezza		8011578975326	€ 3,50
	1813.207 4 ruote		8011578975340	€ 115,00 new
	1813.209 maniglione		8011578975364	€ 49,00 new
	1813.212 guida		8011578985646	€ 26,00 new

1813.005

ACCESSORIO PORTA CARTA PAPER TOWEL HOLDER



Icona	Descrizione	Quantità	Barcode	Prezzo
	1813.005	200	8011578974909	€ 25,00

1813.010

ACCESSORIO MAGNETICO PORTA CARTA max Kg 1,2 MAGNETIC PAPER TOWEL HOLDER



Icona	Descrizione	Quantità	Barcode	Prezzo
	1813.010	1005	8011578971625	€ 27,00

1813.020

ACCESSORIO MAGNETICO PORTA FLACONI MAGNETIC AEROSOL HOLDER



Icona	Descrizione	Quantità	Barcode	Prezzo
	1813.020	630	8011578971649	€ 26,00

1812.210

CARRELLO-PRO 7 CASSETTI - piano di lavoro in ABS - paracolpi angolare - chiusura antiribaltamento - vuoto
TROLLEY-PRO 7 DRAWERS - ABS top - bumpers - one drawer opening - empty

piano di lavoro ABS
 ABS top
ANTIRIBALTAMENTO



piano di lavoro in ABS con divisori
 ABS top with grid

paracolpi angolare
 angular bumpers

CARICO STATICO
TOTAL STATIC LOAD
KG. 1000

chiusura ANTIRIBALTAMENTO apertura singola cassetti
 one drawer opening safety system



ruote rinforzate
 reinforced wheels

- 6 cassetti / drawers h 65 x 385 x 570
- 1 cassetti / drawer h 200 x 385 x 570
- Carico statico totale / total static load Kg 1.000 per cassetto / each drawer kg 40
- Guide telescopiche a sfera / ball bearing slides
- Ruote 5"x2": 2 ruote fisse - 2 ruote girevoli con freno / 2 wheels - 2 wheel with brake
- Chiusura ANTIRIBALTAMENTO apertura singola cassetto / one drawer opening safety system
- Serratura centralizzata / lock
- Piano di lavoro in ABS con divisori / ABS top with grid
- PARACOLPI angolari / angular bumpers
- Maniglione reversibile destra sinistra / left-right reverse handle

				
1812.210	705 x 447 x 1000	58000	8011578975265	780,00

1813.201	serratura/lock	8011578975302	10,60
1813.205	chiave grezza	8011578975326	3,50
1813.208	4 ruote	8011578986049	125,00 new
1813.313	guida	8011578985660	26,00 new

1813.005

ACCESSORIO PORTA CARTA
PAPER TOWEL HOLDER







			
1813.005	200	8011578974909	25,00

1813.010

ACCESSORIO MAGNETICO
PORTA CARTA max Kg 1,2
MAGNETIC PAPER TOWEL HOLDER



			
1813.010	1005	8011578971625	27,00

1813.020

ACCESSORIO MAGNETICO
PORTA FLACONI
MAGNETIC AEROSOL HOLDER



			
1813.020	630	8011578971649	26,00

1810.064 CARRELLO 64 UTENSILI - 6 moduli
TROLLEY 64 TOOLS - 6 modules

Pro INDUSTRIAL



piano di lavoro GOMMA
RUBBER top



1810.064 carrello con 64 utensili
trolley with 64 tools



68900



8011578100004



1.222,55

1812.064 CARRELLO-PRO 64 UTENSILI- 6 mod.
TROLLEY-PRO 64 TOOLS - 6 modules

Pro INDUSTRIAL



piano di lavoro ABS
ABS top
ANTIRIBALTAMENTO



1812.064 carrello con 64 utensili
trolley with 64 tools



79900



8011578971663



1.322,55



1815.010

1815.040

1815.100



1815.120

1815.140

1815.150

1815.010:

0050.307 3 x 75 0050.815 8 x 150 0055.603 6 x 38
0050.410 4 x 100 0052.006 PH 0 x 60 0056.103 PH 1 x 38
0050.510 5,5 x 100 0052.108 PH 1 x 80
0050.612 6,5 x 125 0052.210 PH 2 x 100

1815.040:

1030.060 mm 6 1030.120 mm 12 1030.180 mm 18
1030.070 mm 7 1030.130 mm 13 1030.190 mm 19
1030.080 mm 8 1030.140 mm 14 1030.200 mm 20
1030.090 mm 9 1030.150 mm 15 1030.220 mm 22
1030.100 mm 10 1030.160 mm 16 1030.240 mm 24
1030.110 mm 11 1030.170 mm 17

1815.100:

1500.080 mm 8 1500.160 mm 16 1500.270 mm 27
1500.090 mm 9 1500.170 mm 17 1500.300 mm 30
1500.100 mm 10 1500.180 mm 18 1500.320 mm 32
1500.110 mm 11 1500.190 mm 19 1505.010
1500.120 mm 12 1500.200 mm 20 1508.125 mm 125
1500.130 mm 13 1500.210 mm 21 1508.250 mm 250
1500.140 mm 14 1500.220 mm 22 1510.010
1500.150 mm 15 1500.240 mm 24 1512.010

1815.120:

0377.030 gr 300 0616.015 mm 150
0370.035 mm 35 0612.016 mm 160

1815.140:

0440.918 mm 180 0463.916 mm 160 0490.024 mm 240
0412.916 mm 160 0474.025 mm 250

1815.150:

0505.018 mm 180 0510.018 mm 180
0506.017 mm 170 0511.017 mm 170

1814.064 ASSORTIMENTO 64 UTENSILI - 6 moduli
SET 64 TOOLS - 6 modules



1814.064



9900



8011578949006



542,55

Contenuto-content:

1815.010 1815.120
1815.040 1815.140
1815.100 1815.150

1810.067

CARRELLO 67 UTENSILI - 6 moduli TROLLEY 67 TOOLS - 6 modules

Pro
INDUSTRIAL



piano di lavoro GOMMA
RUBBER top

 **1810.067** carrello con 67 utensili
trolley with 67 tools

 68700  8011578100047  **1.204,25**

1812.067

CARRELLO-PRO 67 UTENSILI- 6 mod. TROLLEY-PRO 67 TOOLS - 6 modules

Pro
INDUSTRIAL



piano di lavoro ABS
ABS top
ANTIRIBALTAMENTO

 **1812.067** carrello con 67 utensili
trolley with 67 tools

 69700  8011578974800  **1.304,25**



1815.010 1815.040 1815.100





1815.120 1815.140 1815.180

- 1815.010:**
 0050.307 3 x 75 0050.815 8 x 150 0055.603 6 x 38
 0050.410 4 x 100 0052.006 PH 0 x 60 0056.103 PH 1 x 38
 0050.510 5,5 x 100 0052.108 PH 1 x 80
 0050.612 6,5 x 125 0052.210 PH 2 x 100
- 1815.040:**
 1030.060 mm 6 1030.120 mm 12 1030.180 mm 18
 1030.070 mm 7 1030.130 mm 13 1030.190 mm 19
 1030.080 mm 8 1030.140 mm 14 1030.200 mm 20
 1030.090 mm 9 1030.150 mm 15 1030.220 mm 22
 1030.100 mm 10 1030.160 mm 16 1030.240 mm 24
 1030.110 mm 11 1030.170 mm 17
- 1815.100:**
 1500.080 mm 8 1500.160 mm 16 1500.270 mm 27
 1500.090 mm 9 1500.170 mm 17 1500.300 mm 30
 1500.100 mm 10 1500.180 mm 18 1500.320 mm 32
 1500.110 mm 11 1500.190 mm 19 1505.010
 1500.120 mm 12 1500.200 mm 20 1508.125 mm 125
 1500.130 mm 13 1500.210 mm 21 1508.250 mm 250
 1500.140 mm 14 1500.220 mm 22 1510.010
 1500.150 mm 15 1500.240 mm 24 1512.010
- 1815.120:**
 0377.030 gr 300 0616.015 mm 150
 0370.035 mm 35 0612.016 mm 160
- 1815.140:**
 0440.918 mm 180 0463.916 mm 160 0490.024 mm 240
 0412.916 mm 160 0474.025 mm 250
- 1815.180:**
 0344.020 mm 2 0344.040 mm 4 0344.080 mm 8
 0344.025 mm 2,5 0344.050 mm 5
 0344.030 mm 3 0344.060 mm 6

1814.067

ASSORTIMENTO 67 UTENSILI - 6 moduli SET 67 TOOLS - 6 modules

 **1814.067**

 9700  8011578949020  **524,25**

Contenuto-content:
 1815.010 1815.120
 1815.040 1815.140
 1815.100 1815.180

1810.128 CARRELO 128 UTENSILI - 9 moduli
 TROLLEY 128 TOOLS - 9 modules

Pro INDUSTRIAL



piano di lavoro GOMMA
 RUBBER top



1810.128 carrello con 128 utensili
 trolley with 128 tools



72400



8011578810004



1.497,70

1812.128 CARRELO-PRO 128 UTENSILI - 9 mod.
 TROLLEY-PRO 128 TOOLS - 9 mod.

Pro INDUSTRIAL



piano di lavoro ABS
 ABS top
 ANTIRIBALTAMENTO



1812.128 carrello con 128 utensili
 trolley with 128 tools



74400



8011578975227



1.597,70



1815.010



1815.100



1815.150

1815.010:

0050.307	3 x 75	0050.815	8 x 150	0055.603	6 x 38
0050.410	4 x 100	0052.006	PH 0 x 60	0056.103	PH 1 x 38
0050.510	5,5 x 100	0052.108	PH 1 x 80		
0050.612	6,5 x 125	0052.210	PH 2 x 100		

1815.040:

1030.060	mm 6	1030.120	mm 12	1030.180	mm 18
1030.070	mm 7	1030.130	mm 13	1030.190	mm 19
1030.080	mm 8	1030.140	mm 14	1030.200	mm 20
1030.090	mm 9	1030.150	mm 15	1030.220	mm 22
1030.100	mm 10	1030.160	mm 16	1030.240	mm 24
1030.110	mm 11	1030.170	mm 17		

1815.090:

1400.040	mm 4	1400.120	mm 12	1438.200	TX 20
1400.045	mm 4,5	1400.130	mm 13	1438.250	TX 25
1400.050	mm 5	1436.030	mm 3	1438.270	TX 27
1400.055	mm 5,5	1436.040	mm 4	1438.300	TX 30
1400.060	mm 6	1436.050	mm 5	1438.400	TX 40
1400.070	mm 7	1436.060	mm 6	1405.010	
1400.080	mm 8	1436.080	mm 8	1408.075	mm 75
1400.090	mm 9	1438.080	TX 8	1408.150	mm 150
1400.100	mm 10	1438.100	TX 10	1410.010	
1400.110	mm 11	1438.150	TX15	1412.010	
0351.090	mm 1,5-2-2,5-3-4-5-6-8-10				
0366.090	TX 10-15-20-25-27-30-40-45-50				

1815.100:

1500.080	mm 8	1500.160	mm 16	1500.270	mm 27
1500.090	mm 9	1500.170	mm 17	1500.300	mm 30
1500.100	mm 10	1500.180	mm 18	1500.320	mm 32
1500.110	mm 11	1500.190	mm 19	1505.010	
1500.120	mm 12	1500.200	mm 20	1508.125	mm 125
1500.130	mm 13	1500.210	mm 21	1508.250	mm 250
1500.140	mm 14	1500.220	mm 22	1510.010	
1500.150	mm 15	1500.240	mm 24	1512.010	

1815.120:

0377.030	gr 300	0616.015	mm 150
0370.035	mm 35	0612.016	mm 160

1815.140:

0440.918	mm 180	0463.916	mm 160	0490.024	mm 240
0412.916	mm 160	0474.025	mm 250		

1815.150:

0505.018	mm 180	0510.018	mm 180
0506.017	mm 170	0511.017	mm 170

1815.180:

0344.020	mm 2	0344.040	mm 4	0344.080	mm 8
0344.025	mm 2,5	0344.050	mm 5		
0344.030	mm 3	0344.060	mm 6		

1815.300:

0560.025	mm 250	1070.020	mm 200
0683.010		0620.010	

1814.128 ASSORTIMENTO 128 UTENSILI - 9 moduli
 SET 128 TOOLS - 9 modules



1814.128



13400



8011578949044



817,70

Contenuto-content:

1815.010	1815.120	1815.300
1815.040	1815.140	
1815.090	1815.150	
1815.100	1815.180	

1810.164 CARRELLO 164 UTENSILI - 9 moduli
 TROLLEY 164 TOOLS - 9 modules

Pro
 INDUSTRIAL



piano di lavoro GOMMA
 RUBBER top

 **1810.164** carrello con 164 utensili
 trolley with 164 tools

 75485  0115781000004  **1.676,80**

1812.164 CARRELLO-PRO 164 UTENSILI - 9 mod.
 TROLLEY-PRO 164 TOOLS - 9 mod.

Pro
 INDUSTRIAL



piano di lavoro ABS
 ABS top
 ANTIRIBALTAMENTO

 **1812.164** carrello con 164 utensili
 trolley with 164 tools

 77485  0115781000004  **1.776,80**



1815.010 1815.020 1815.040



1815.050 1815.090 1815.100



1815.180 1815.140 1815.150



1150.080 - 1150.100 - 1150.130 - 1150.150 - 1150.170



0234.010

1815.010: 0050.307 3 x 75 0050.410 4 x 100 0050.510 5,5 x 100 0050.612 6,5 x 125	0050.815 8 x 150 0052.006 PH 0 x 60 0052.108 PH 1 x 80 0052.210 PH 2 x 100	0055.603 6 x 38 0056.103 PH 1 x 38 0075.108 PH 1 x 80 0075.015 PH 2 x 100	0075.027 TX 27 0075.030 TX 30	1400.055 mm 5,5 1400.060 mm 6 1400.070 mm 7 1400.080 mm 8 1400.090 mm 9 1400.100 mm 10 1400.110 mm 11 0351.090 mm 1,5-2-2,5-3-4-5-6-8-10 0366.090 TX 10-15-20-25-27-30-40-45-50	1436.040 mm 4 1436.050 mm 5 1436.060 mm 6 1436.080 mm 8 1438.080 TX 8 1438.100 TX 10 1438.150 TX15	1438.300 TX 30 1438.400 TX 40 1405.010 mm 75 1408.075 mm 150 1408.150 mm 150 1410.010 mm 142.010	1815.180: 0344.020 mm 2 0344.025 mm 2,5 0344.030 mm 3 0344.040 mm 4 0344.050 mm 5 0344.060 mm 6 0344.080 mm 8	0234.010: 239.010 249.350 3,5 x 25 249.400 4 x 25 249.550 5,5 x 25 249.600 6 x 25 249.650 6,5 x 25 250.100 PH 1 x 25 250.200 PH 2 x 25 250.300 PH 3 x 25 251.100 PZ 1 x 25 251.200 PZ 2 x 25 251.300 PZ 3 x 25 253.080 TX 8 253.090 TX 9	253.100 TX 10 253.150 TX 15 253.200 TX 20 253.250 TX 25 253.270 TX 27 253.300 TX 30 253.400 TX 40 263.020 ES./HEX. mm 2 263.025 ES./HEX. mm 2,5 263.030 ES./HEX. mm 3 263.040 ES./HEX. mm 4 263.050 ES./HEX. mm 5 263.060 ES./HEX. mm 6
---	---	--	----------------------------------	---	--	---	---	---	---

1814.164 ASSORTIMENTO 164 UTENSILI - 9 moduli
 SET 164 TOOLS - 9 modules

 **1814.164**

 13245  0115781000004  **996,80**

Contenuto-content:
 1815.010 1815.090 1815.180 1150.130
 1815.020 1815.100 0234.010 1150.150
 1815.040 1815.140 1150.080 1150.170
 1815.050 1815.150 1150.100

1810.166 CARRELLINO 166 UTENSILI - 13 moduli
 TROLLEY 166 TOOLS - 13 modules

Pro INDUSTRIAL



piano di lavoro GOMMA
 RUBBER top



1810.166 carrello con 166 utensili
 trolley with 166 tools



77100



8011578810085



1.893,45

1812.166 CARRELLINO-PRO 166 UTENSILI- 13 mod.
 TROLLEY-PRO 166 TOOLS - 13 mod.

Pro INDUSTRIAL



piano di lavoro ABS
 ABS top
 ANTIRIBALTAMENTO



1812.166 carrello con 166 utensili
 trolley with 166 tools



78100



8011578974824



1.996,45

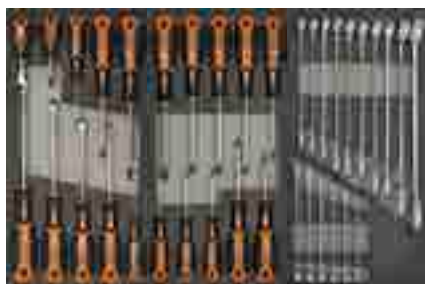

1815.010 1815.020 1815.040

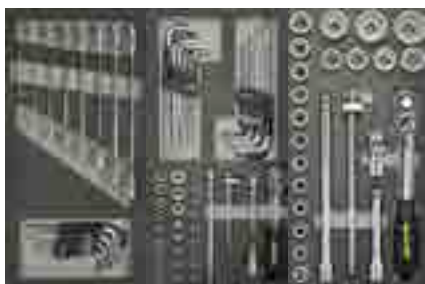

1815.070 1815.090 1815.100



1815.120 1815.140 1815.150



1815.180 1815.200 1815.300

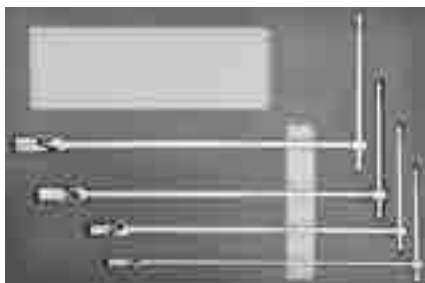

1815.380

1815.010:

0050.307	3 x 75	0050.815	8 x 150	0055.603	6 x 38
0050.410	4 x 100	0052.006	PH 0 x 60	0056.103	PH 1 x 38
0050.510	5,5 x 100	0052.108	PH 1 x 80		
0050.612	6,5 x 125	0052.210	PH 2 x 100		

1815.020:

0075.060	TX 6	0075.100	TX 10	0075.027	TX 27
0075.070	TX 7	0075.015	TX 15	0075.030	TX 30
0075.080	TX 8	0075.020	TX 20		
0075.090	TX 9	0075.025	TX 25		

1815.040:

1030.060	mm 6	1030.120	mm 12	1030.180	mm 18
1030.070	mm 7	1030.130	mm 13	1030.190	mm 19
1030.080	mm 8	1030.140	mm 14	1030.200	mm 20
1030.090	mm 9	1030.150	mm 15	1030.220	mm 22
1030.100	mm 10	1030.160	mm 16	1030.240	mm 24
1030.110	mm 11	1030.170	mm 17		

1815.070:

1020.067	mm 6x7	1020.123	mm 12x13	1020.189	mm
18x19					
1020.089	mm 8x9	1020.145	mm 14x15	1020.202	mm
20x22					
1020.101	mm 10x11	1020.167	mm 16x17		
0347.090	mm 1,5-2-2,5-3-4-5-6-8-10				

1815.090:

1400.040	mm 4	1400.120	mm 12	1438.200	TX 20
1400.045	mm 4,5	1400.130	mm 13	1438.250	TX 25
1400.050	mm 5	1436.030	mm 3	1438.270	TX 27
1400.055	mm 5,5	1436.040	mm 4	1438.300	TX 30
1400.060	mm 6	1436.050	mm 5	1438.400	TX 40
1400.070	mm 7	1436.060	mm 6	1405.010	
1400.080	mm 8	1436.080	mm 8	1408.075	mm 75
1400.090	mm 9	1438.080	TX 8	1408.150	mm 150
1400.100	mm 10	1438.100	TX 10	1410.010	
1400.110	mm 11	1438.150	TX15	1412.010	
0351.090	mm 1,5-2-2,5-3-4-5-6-8-10				
0366.090	TX 10-15-20-25-27-30-40-45-50				

1815.100:

1500.080	mm 8	1500.160	mm 16	1500.270	mm 27
1500.090	mm 9	1500.170	mm 17	1500.300	mm 30
1500.100	mm 10	1500.180	mm 18	1500.320	mm 32
1500.110	mm 11	1500.190	mm 19	1505.010	
1500.120	mm 12	1500.200	mm 20	1508.125	mm 125
1500.130	mm 13	1500.210	mm 21	1508.250	mm 250
1500.140	mm 14	1500.220	mm 22	1510.010	
1500.150	mm 15	1500.240	mm 24	1512.010	

1815.120:

0377.030	gr 300	0616.015	mm 150
0370.035	mm 35	0612.016	mm 160

1815.140:

0440.918	mm 180	0463.916	mm 160	0490.024	mm 240
0412.916	mm 160	0474.025	mm 250		

1815.150:

0505.018	mm 180	0510.018	mm 180
0506.017	mm 170	0511.017	mm 170

1815.180:

0344.020	mm 2	0344.040	mm 4	0344.080	mm 8
0344.025	mm 2,5	0344.050	mm 5		
0344.030	mm 3	0344.060	mm 6		

1815.200:

0344.320	mm 2	0344.340	mm 4	0344.380	mm 8
0344.325	mm 2,5	0344.350	mm 5		
0344.330	mm 3	0344.360	mm 6		

1815.300:

0560.025	mm 250	1070.020	mm 200
0683.010		0620.010	

1815.380:

1150.080	mm 8	1150.130	mm 13
1150.100	mm 10	1150.170	mm 17

1814.166 ASSORTIMENTO 166 UTENSILI - 13 moduli
 SET 166 TOOLS - 13 modules



1814.166



18100



8011578949068



1.213,45

Contenuto-content:

1815.010	1815.090	1815.150	1815.380
1815.020	1815.100	1815.180	
1815.040	1815.120	1815.200	
1815.070	1815.140	1815.300	

1810.181

CARRELLO 181 UTENSILI - 15 moduli
TROLLEY 181 TOOLS - 15 modules

Pro
 INDUSTRIAL



piano di lavoro GOMMA
RUBBER top

 **1810.181** carrello con 181 utensili
 trolley with 181 tools

 79500  0115781000004  **2.021,10**

1812.181

CARRELLO-PRO 181 UTENSILI - 15 mod.
TROLLEY-PRO 181 TOOLS - 15 mod.

Pro
 INDUSTRIAL



piano di lavoro ABS
ABS top
ANTIRIBALTAMENTO

 **1812.181** carrello con 181 utensili
 trolley with 181 tools

 80500  0115781000004  **2.121,10**



1815.010 1815.020 1815.040



1815.050 1815.070 1815.090



1815.100 1815.120 1815.140



1815.150 1815.180 1815.200



1815.220 1815.260 1815.300

1815.010:	0050.307 3 x 75	0050.815 8 x 150	0055.603 6 x 38
	0050.410 4 x 100	0052.006 PH 0 x 60	0056.103 PH 1 x 38
	0050.510 5,5 x 100	0052.108 PH 1 x 80	
	0050.612 6,5 x 125	0052.210 PH 2 x 100	
1815.020:	0075.060 TX 6	0075.100 TX 10	0075.027 TX 27
	0075.070 TX 7	0075.015 TX 15	0075.030 TX 30
	0075.080 TX 8	0075.020 TX 20	
	0075.090 TX 9	0075.025 TX 25	
1815.040:	1030.060 mm 6	1030.120 mm 12	1030.180 mm 18
	1030.070 mm 7	1030.130 mm 13	1030.190 mm 19
	1030.080 mm 8	1030.140 mm 14	1030.200 mm 20
	1030.090 mm 9	1030.150 mm 15	1030.220 mm 22
	1030.100 mm 10	1030.160 mm 16	1030.240 mm 24
	1030.110 mm 11	1030.170 mm 17	
1815.050:	1030.270 mm 27	1030.300 mm 30	1030.320 mm 32
1815.070:	1020.067 18x19 mm 6x7	1020.123 mm 12x13	1020.189 mm
	1020.089 20x22 mm 8x9	1020.145 mm 14x15	1020.202 mm
	1020.101 mm 10x11	1020.167 mm 16x17	

0347.090 mm 1,5-2-2,5-3-4-5-6-8-10			
1815.090:	1400.040 mm 4	1400.120 mm 12	1438.200 TX 20
	1400.045 mm 4,5	1400.130 mm 13	1438.250 TX 25
	1400.050 mm 5	1436.030 mm 3	1438.270 TX 27
	1400.055 mm 5,5	1436.040 mm 4	1438.300 TX 30
	1400.060 mm 6	1436.050 mm 5	1438.400 TX 40
	1400.070 mm 7	1436.060 mm 6	1405.010 mm 2
	1400.080 mm 8	1436.080 mm 8	1408.075 mm 2,5
	1400.090 mm 9	1438.080 TX 8	1408.150 mm 150
	1400.100 mm 10	1438.100 TX 10	1410.010
	1400.110 mm 11	1438.150 TX15	1412.010
0351.090 mm 1,5-2-2,5-3-4-5-6-8-10			
0366.090 TX 10-15-20-25-27-30-40-45-50			
1815.100:	1500.080 mm 8	1500.160 mm 16	1500.270 mm 27
	1500.090 mm 9	1500.170 mm 17	1500.300 mm 30
	1500.100 mm 10	1500.180 mm 18	1500.320 mm 32
	1500.110 mm 11	1500.190 mm 19	1505.010
	1500.120 mm 12	1500.200 mm 20	1508.125 mm 125
	1500.130 mm 13	1500.210 mm 21	1508.250 mm 250
	1500.140 mm 14	1500.220 mm 22	1510.010
	1500.150 mm 15	1500.240 mm 24	1512.010
1815.120:	0377.030 gr 300	0616.015 mm 150	
	0370.035 mm 35	0612.016 mm 160	

1815.140:	0440.918 mm 180	0463.916 mm 160	0490.024 mm 240
	0412.916 mm 160	0474.025 mm 250	
1815.150:	0505.018 mm 180	0510.018 mm 180	
	0506.017 mm 170	0511.017 mm 170	
1815.180:	0344.020 mm 2	0344.040 mm 4	0344.080 mm 8
	0344.025 mm 2,5	0344.050 mm 5	
	0344.030 mm 3	0344.060 mm 6	
1815.200:	0344.320 mm 2	0344.340 mm 4	0344.380 mm 8
	0344.325 mm 2,5	0344.350 mm 5	
	0344.330 mm 3	0344.360 mm 6	
1815.220:	1098.080 mm 8	1098.110 mm 11	1098.170 mm 17
	1098.090 mm 9	1098.130 mm 13	1098.190 mm 19
	1098.100 mm 10	1098.140 mm 14	
1815.260:	1055.080 mm 8	1055.120 mm 12	1055.170 mm 17
	1055.100 mm 10	1055.130 mm 13	1055.190 mm 19
	1055.110 mm 11	1055.140 mm 14	
1815.300:	0560.025 mm 250	1070.020 mm 200	
	0683.010	0620.010	

1814.181

ASSORTIMENTO 181 UTENSILI - 15 moduli
SET 181 TOOLS - 15 modules

 **1814.181**

 20500  0115781000004  **1.341,10**

Contenuto-content:
 1815.010 1815.070 1815.140 1815.220
 1815.020 1815.090 1815.150 1815.260
 1815.040 1815.100 1815.180 1815.300
 1815.050 1815.120 1815.200

1810.185 CARRELLINO 185 UTENSILI - 16 moduli
 TROLLEY 185 TOOLS - 16 modules

Pro INDUSTRIAL



piano di lavoro GOMMA
 RUBBER top

1810.185 carrello con 185 utensili
 trolley with 185 tools

81300  €
 8011578810122 2.191,60

1812.185 CARRELLINO-PRO 185 UTENSILI - 16 mod.
 TROLLEY-PRO 185 TOOLS - 16 mod.

Pro INDUSTRIAL



piano di lavoro ABS
 ABS top
 ANTIRIBALTAMENTO

1812.185 carrello con 185 utensili
 trolley with 185 tools

82400  €
 8011578974763 2.291,60



1815.010 1815.020 1815.040



1815.050 1815.070 1815.090



1815.100 1815.120 1815.140



1815.150 1815.180 1815.200



1815.220 1815.260 1815.300

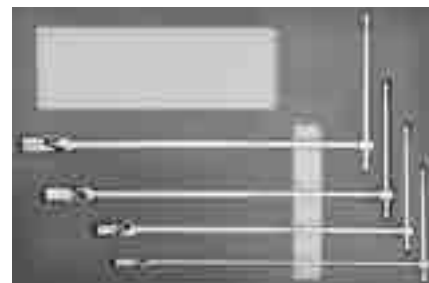

1815.380

1815.010:

0050.307	3 x 75	0050.815	8 x 150	0055.603	6 x 38
0050.410	4 x 100	0052.006	PH 0 x 60	0056.103	PH 1 x 38
0050.510	5,5 x 100	0052.108	PH 1 x 80		
0050.612	6,5 x 125	0052.210	PH 2 x 100		

1815.020:

0075.060	TX 6	0075.100	TX 10	0075.027	TX 27
0075.070	TX 7	0075.015	TX 15	0075.030	TX 30
0075.080	TX 8	0075.020	TX 20		
0075.090	TX 9	0075.025	TX 25		

1815.040:

1030.060	mm 6	1030.120	mm 12	1030.180	mm 18
1030.070	mm 7	1030.130	mm 13	1030.190	mm 19
1030.080	mm 8	1030.140	mm 14	1030.200	mm 20
1030.090	mm 9	1030.150	mm 15	1030.220	mm 22
1030.100	mm 10	1030.160	mm 16	1030.240	mm 24
1030.110	mm 11	1030.170	mm 17		

1815.050:

1030.270	mm 27	1030.300	mm 30	1030.320	mm 32
----------	-------	----------	-------	----------	-------

1815.070:

1020.067	mm 6x7	1020.123	mm 12x13	1020.189	mm
1020.089	mm 8x9	1020.145	mm 14x15	1020.202	mm
1020.101	mm 10x11	1020.167	mm 16x17		
0347.090	mm 1,5-2-2,5-3-4-5-6-8-10				

1815.090:

1400.040	mm 4	1400.120	mm 12	1438.200	TX 20
1400.045	mm 4,5	1400.130	mm 13	1438.250	TX 25
1400.050	mm 5	1436.030	mm 3	1438.270	TX 27
1400.055	mm 5,5	1436.040	mm 4	1438.300	TX 30
1400.060	mm 6	1436.050	mm 5	1438.400	TX 40
1400.070	mm 7	1436.060	mm 6	1405.010	
1400.080	mm 8	1436.080	mm 8	1408.075	mm 75
1400.090	mm 9	1438.080	TX 8	1408.150	mm 150
1400.100	mm 10	1438.100	TX 10	1410.010	
1400.110	mm 11	1438.150	TX15	1412.010	
0351.090	mm 1,5-2-2,5-3-4-5-6-8-10				
0366.090	TX 10-15-20-25-27-30-40-45-50				

1815.100:

1500.080	mm 8	1500.160	mm 16	1500.270	mm 27
1500.090	mm 9	1500.170	mm 17	1500.300	mm 30
1500.100	mm 10	1500.180	mm 18	1500.320	mm 32
1500.110	mm 11	1500.190	mm 19	1505.010	
1500.120	mm 12	1500.200	mm 20	1508.125	mm 125
1500.130	mm 13	1500.210	mm 21	1508.250	mm 250
1500.140	mm 14	1500.220	mm 22	1510.010	
1500.150	mm 15	1500.240	mm 24	1512.010	

1815.120:

0377.030	gr 300	0616.015	mm 150		
0370.035	mm 35	0612.016	mm 160		

1815.140:

0440.918	mm 180	0463.916	mm 160	0490.024	mm 240
----------	--------	----------	--------	----------	--------

0412.916	mm 160	0474.025	mm 250		
1815.150:					
0505.018	mm 180	0510.018	mm 180		
0506.017	mm 170	0511.017	mm 170		
1815.180:					
0344.020	mm 2	0344.040	mm 4	0344.080	mm 8
0344.025	mm 2,5	0344.050	mm 5		
0344.030	mm 3	0344.060	mm 6		
1815.200:					
0344.320	mm 2	0344.340	mm 4	0344.380	mm 8
0344.325	mm 2,5	0344.350	mm 5		
0344.330	mm 3	0344.360	mm 6		
1815.220:					
1098.080	mm 8	1098.110	mm 11	1098.170	mm 17
1098.090	mm 9	1098.130	mm 13	1098.190	mm 19
1098.100	mm 10	1098.140	mm 14		
1815.260:					
1055.080	mm 8	1055.120	mm 12	1055.170	mm 17
1055.100	mm 10	1055.130	mm 13	1055.190	mm 19
1055.110	mm 11	1055.140	mm 14		
1815.300:					
0560.025	mm 250	1070.020	mm 200		
0683.010	mm 250	0620.010			
1815.380:					
1150.080	mm 8	1150.130	mm 13		
1150.100	mm 10	1150.170	mm 17		

1814.185 ASSORT. 185 UTENSILI - 16 moduli
 SET 185 TOOLS - 16 modules

1814.185

22300  €
 8011578949105 1.511,60

Contenuto-content:
 1815.010 1815.070 1815.140 1815.220
 1815.020 1815.090 1815.150 1815.260
 1815.040 1815.100 1815.180 1815.300
 1815.050 1815.120 1815.200 1815.380

1810.216

CARRELLO 216 UTENSILI - 11 mod. TROLLEY 216 TOOLS - 11 modules

Pro INDUSTRIAL



piano di lavoro GOMMA
RUBBER top

1810.216 carrello con 216 utensili
trolley with 216 tools

74890 80115781000004 € 1.663,90

1812.216

CARRELLO-PRO 216 UTENSILI - 11 mod. TROLLEY-PRO 216 TOOLS - 11 mod.

Pro INDUSTRIAL



piano di lavoro ABS
ABS top
ANTIRIBALTAMENTO

1812.216 carrello con 216 utensili
trolley with 216 tools

76890 80115781000004 € 1.763,90

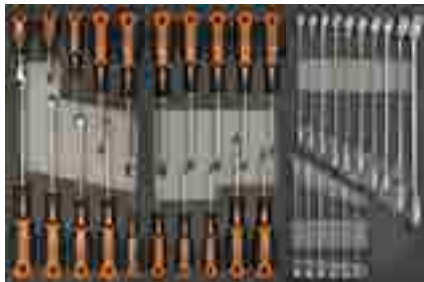

1815.010 1815.020 1815.040

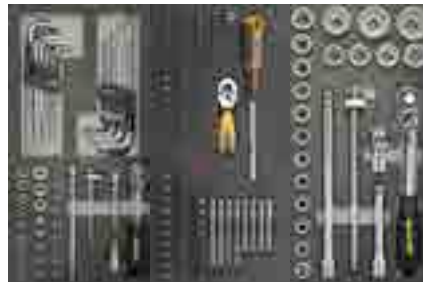

1815.090 1815.095 1815.100



1815.120 1815.140 1815.150

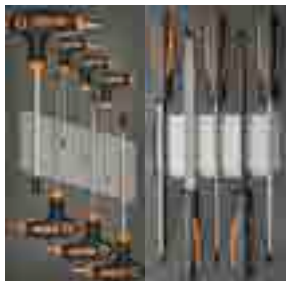

1815.180 1815.330

1815.010:
 0050.307 3 x 75 0050.815 8 x 150 0055.603 6 x 38
 0050.410 4 x 100 0052.006 PH 0 x 60 0056.103 PH 1 x 38
 0050.510 5,5 x 100 0052.108 PH 1 x 80
 0050.612 6,5 x 125 0052.210 PH 2 x 100
1815.020:
 0075.060 TX 6 0075.100 TX 10 0075.027 TX 27
 0075.070 TX 7 0075.015 TX 15 0075.030 TX 30
 0075.080 TX 8 0075.020 TX 20
 0075.090 TX 9 0075.025 TX 25
1815.040:
 1030.060 mm 6 1030.120 mm 12 1030.180 mm 18
 1030.070 mm 7 1030.130 mm 13 1030.190 mm 19
 1030.080 mm 8 1030.140 mm 14 1030.200 mm 20
 1030.090 mm 9 1030.150 mm 15 1030.220 mm 22
 1030.100 mm 10 1030.160 mm 16 1030.240 mm 24
 1030.110 mm 11 1030.170 mm 17
1815.090:
 1400.040 mm 4 1400.120 mm 12 1438.200 TX 20
 1400.045 mm 4,5 1400.130 mm 13 1438.250 TX 25
 1400.050 mm 5 1436.030 mm 3 1438.270 TX 27
 1400.055 mm 5,5 1436.040 mm 4 1438.300 TX 30
 1400.060 mm 6 1436.050 mm 5 1438.400 TX 40
 1400.070 mm 7 1436.060 mm 6 1405.010
 1400.080 mm 8 1436.080 mm 8 1408.075 mm 75
 1400.090 mm 9 1438.080 TX 8 1408.150 mm 150
 1400.100 mm 10 1438.100 TX 10 1410.010
 1400.110 mm 11 1438.150 TX15 1412.010

0351.090 mm 1,5-2-2,5-3-4-5-6-8-10
 0366.090 TX 10-15-20-25-27-30-40-45-50
1815.095:
 0249.400 mm 4x25 0255.300 TX 30x25 0263.950 mm 5x50
 0249.500 mm 5x25 0255.400 TX 40x25 0263.960 mm 6x50
 0249.600 mm 6x25 0263.015 mm 1,5x25 0245.100 PH 1x75
 0250.100 PH 1x25 0263.020 mm 2x25 0245.200 PH 2x75
 0250.200 PH 2x25 0263.025 mm 2,5x25 0245.109 PH 1x90
 0250.300 PH 3x25 0263.030 mm 3x25 0245.209 PH 2x90
 0251.100 PZ 1x25 0263.040 mm 4x25 0246.100 PZ 1x75
 0251.200 PZ 2x25 0263.050 mm 5x25 0246.109 PZ 1x90
 0251.300 PZ 3x25 0263.060 mm 6x25 0246.200 PZ 2x75
 0253.060 TX 6x25 1420.010 0246.209 PZ 2x90
 0253.070 TX 7x25 0084.010 1407.010
 0253.080 TX 8x25 0250.910 PH 1x25 T 0258.910 PZ 1x50 T
 0253.090 TX 9x25 0250.920 PH 2x25 T 0258.920 PZ 2x50 T
 0253.100 TX 10x25 0250.930 PH 3x25 T 0258.910 PZ 1x50 T
 0253.150 TX 15x25 0251.910 PZ 1x25 T 0258.920 PZ 2x50 T
 0253.200 TX 20x25 0251.920 PZ 2x25 T 0255.906 TX 6x50
 0253.250 TX 25x25 0251.930 PZ 3x25 T 0255.907 TX 7x50
 0253.270 TX 27x25 0258.100 PZ 1x50 0255.908 TX 8x50
 0253.300 TX 30x25 0258.200 PZ 2x50 0255.909 TX 9x50
 0255.060 TX 6x25 0258.300 PZ 3x50 0255.910 TX 10x50
 0255.070 TX 7x25 0260.100 PH 1x50 0255.915 TX 15x50
 0255.080 TX 8x25 0260.200 PH 2x50 0255.920 TX 20x50
 0255.090 TX 9x25 0260.300 PH 3x50 0255.925 TX 25x50
 0255.100 TX 10x25 0262.400 mm 4x50 0255.927 TX 27x50
 0255.150 TX 15x25 0262.500 mm 5x50 0255.930 TX 30x50

0255.200 TX 20x25 0262.600 mm 6x50 0255.940 TX 40x50
 0255.250 TX 25x25 0263.930 mm 3x50
 0255.270 TX 27x25 0263.940 mm 4x50
1815.100:
 1500.080 mm 8 1500.160 mm 16 1500.270 mm 27
 1500.090 mm 9 1500.170 mm 17 1500.300 mm 30
 1500.100 mm 10 1500.180 mm 18 1500.320 mm 32
 1500.110 mm 11 1500.190 mm 19 1505.010
 1500.120 mm 12 1500.200 mm 20 1508.125 mm 125
 1500.130 mm 13 1500.210 mm 21 1508.250 mm 250
 1500.140 mm 14 1500.220 mm 22 1510.010
 1500.150 mm 15 1500.240 mm 24 1512.010
1815.120:
 0377.030 gr 300 0616.015 mm 150
 0370.035 mm 35 0612.016 mm 160
1815.140:
 0440.918 mm 180 0463.916 mm 160 0490.024 mm 240
 0412.916 mm 160 0474.025 mm 250
1815.150:
 0505.018 mm 180 0510.018 mm 180
 0506.017 mm 170 0511.017 mm 170
1815.180:
 0344.020 mm 2 0344.040 mm 4 0344.080 mm 8
 0344.025 mm 2,5 0344.050 mm 5
 0344.030 mm 3 0344.060 mm 6
1815.330:
 0574.090 0574.290 0574.490
 0574.190 0574.390

1814.216

ASSORTIMENTO 216 UTENSILI - 11 moduli SET 216 TOOLS - 11 modules

1814.216

14893 80115781000004 € 983,90

Contenuto-content:
 1815.010 1815.095 1815.150
 1815.020 1815.100 1815.180
 1815.040 1815.120 1815.330
 1815.090 1815.140

1808.210

CARRELLINO 6 CASSETTI tipo STANDARD - piano di lavoro in gomma - vuoto TROLLEY 6 STANDARD type DRAWERS - rubber top - empty

piano di lavoro GOMMA
 RUBBER top

tipo STANDARD
 STANDARD type

piano di lavoro in gomma
 RUBBER top



- 1 cassetto/drawer h 74,5 x 410 x 570
- 4 cassetti/drawers h 100,5 x 410 x 570
- 1 cassetto/drawer h 153,5 x 410 x 570
- Guide telescopiche a sfera/Ball bearing sliders
- 2 ruote fisse - 2 ruote girevoli con freno
 2 wheels - 2 wheel with brake
- Serratura centralizzata/Lock
- Piano di lavoro in gomma/Rubber top mat

  **1808.210** 680 x 460 x 950  48000  8011578 000004  **580,00** **new**

1808.067

CARRELLINO 67 UTENSILI - 6 moduli TROLLEY 67 TOOLS - 6 modules

piano di lavoro GOMMA
 RUBBER top

tipo STANDARD
 STANDARD type



Contenuto-content:

- 1815.010
- 1815.040
- 1815.100
- 1815.120
- 1815.140
- 1815.180

  **1808.067** 680 x 460 x 950 **new**  57700  8011578 000004  **1.104,25**

1808.128

CARRELLINO CON 128 UTENSILI TROLLEY WITH 128 TOOLS

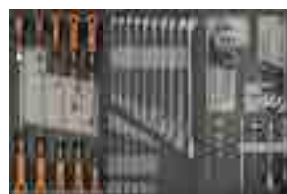

piano di lavoro GOMMA
 RUBBER top

tipo STANDARD
 STANDARD type



Contenuto-content:

- 1815.010 1815.140
- 1815.040 1815.150
- 1815.090 1815.180
- 1815.100 1815.300
- 1815.120





  **1808.128** 680 x 460 x 950 **new**  61400  8011578 000004  **1.397,70**

1815.010 MODULO 10 GIRAVITI
 MODULE 10 SCREWDRIVERS



Contenuto-content:

0050.307	3 x 75	0052.006	PH 0 x 60
0050.410	4 x 100	0052.108	PH 1 x 80
0050.510	5,5 x 100	0052.210	PH 2 x 100
0050.612	6,5 x 125	0055.603	6 x 38
0050.815	8 x 150	0056.103	PH 1 x 38



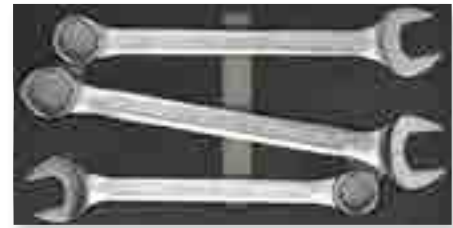

				
1815.010	370 x 188 x 30	735	8011578815004	60,55
1815.012	vuoto - empty	46	8011578815028	18,00

1815.050 MODULO 3 CHIAVI COMB. GRANDI
 MODULE 3 COMB. BIG WRENCHES



Contenuto-content:

1030.270	mm 27
1030.300	mm 30
1030.320	mm 32





				
1815.050	370 x 188 x 30	1322	8011578815127	69,95
1815.052	vuoto - empty	60	8011578815141	18,00

1815.020 MODULO 10 GIRAVITI TORX
 MODULE 10 TORX SCREWDRIVERS



Contenuto-content:

0075.060	TX 6	0075.015	TX 15
0075.070	TX 7	0075.020	TX 20
0075.080	TX 8	0075.025	TX 25
0075.090	TX 9	0075.027	TX 27
0075.100	TX 10	0075.030	TX 30

				
1815.020	370 x 188 x 30	620	8011578815042	63,35
1815.022	vuoto - empty	46	8011578815066	18,00

1815.070 MOD. 8 CHIAVI FORCH. + 9 ES. (17)
 MOD. 8 OPEN WR. + 9 HEX (17)



Contenuto-content:

1020.067	mm 6 x 7	1020.145	mm 14 x 15
1020.089	mm 8 x 9	1020.167	mm16 x 17
1020.101	mm 10 x 11	1020.189	mm18 x 19
1020.123	mm 12 x 13	1020.202	mm20 x 22
0347.090	mm 1,5-2-2,5-3-4-5-6-8-10		



				
1815.070	370 x 188 x 30	1115	8011578815165	61,75
1815.072	vuoto - empty	46	8011578815189	18,00

1815.040 MODULO 17 CHIAVI COMBinate
 MODULE 17 COMB. WRENCHES



Contenuto-content:

1030.060	mm 6	1030.120	mm 12	1030.180	mm 18
1030.070	mm 7	1030.130	mm 13	1030.190	mm 19
1030.080	mm 8	1030.140	mm 14	1030.200	mm 20
1030.090	mm 9	1030.150	mm 15	1030.220	mm 22
1030.100	mm 10	1030.160	mm 16	1030.240	mm 24
1030.110	mm 11	1030.170	mm 17		

				
1815.040	370 x 188 x 30	1860	8011578815080	102,00
1815.042	vuoto - empty	54	8011578815103	18,00

1815.080 MOD. 4 CHIAVI FORCHETTA GRANDI
 MODULE 4 OPEN BIG WRENCHES



Contenuto-content:

1020.213	mm 21 x 23
1020.247	mm 24 x 27
1020.258	mm 25 x 28
1020.302	mm 30 x 32

				
1815.080	370 x 188 x 30	1414	8011578815202	59,45
1815.082	vuoto - empty	60	8011578815226	18,00





1815.083 MODULO 8 CHIAVI POLIGONALI
 MOD. 8 OFFSET DOUBLE RING WR.



Contenuto-content:

- 1025.067 6-7
- 1025.089 8-9
- 1025.101 10-11
- 1025.123 12-13
- 1025.145 14-15
- 1025.167 16-17
- 1025.189 18-19
- 1025.202 20-22



				
1815.083	370 x 188 x 30	1400	8011578969325	69,35
1815.084	vuoto - empty	57	8011578969349	18,00

1815.086 MODULO 20 CHIAVI TORX
 MODULE 20 TORX WRENCHES



Contenuto-content:

- 1048.068 E 6 x E 8
- 1048.102 E 10 x E 12
- 1048.148 E 14 x E 18
- 1048.204 E 20 x E 24
- 1404.040 1/4" TX E 4 FEM
- 1404.050 1/4" TX E 5 FEM
- 1404.060 1/4" TX E 6 FEM
- 1404.070 1/4" TX E 7 FEM
- 1404.080 1/4" TX E 8 FEM
- 1404.100 1/4" TX E 10 FEM
- 1535.100 1/2" TX E 10 FEM
- 1535.120 1/2" TX E 12 FEM
- 1535.140 1/2" TX E 14 FEM
- 1535.160 1/2" TX E 16 FEM
- 1535.180 1/2" TX E 18 FEM
- 1535.200 1/2" TX E 20 FEM
- 1535.240 1/2" TX E 24 FEM
- 0366.090 TX 10-15-20-25-27-30-40-45-50

				
1815.086	370 x 188 x 30	1200	8011578969363	97,20
1815.087	vuoto - empty	57	8011578969387	18,00

1815.090 MOD. 30 BUS. 1/4" + 9 ES. + 9 TX (48)
 MOD. 30 SOCK. 1/4" + 9 HEX + 9 TX (48)



Contenuto-content:

- | | | |
|--|----------------|-----------------|
| 1400.040 mm 4 | 1400.120 mm 12 | 1438.200 TX 20 |
| 1400.045 mm 4,5 | 1400.130 mm 13 | 1438.250 TX 25 |
| 1400.050 mm 5 | 1436.030 mm 3 | 1438.270 TX 27 |
| 1400.055 mm 5,5 | 1436.040 mm 4 | 1438.300 TX 30 |
| 1400.060 mm 6 | 1436.050 mm 5 | 1438.400 TX 40 |
| 1400.070 mm 7 | 1436.060 mm 6 | 1405.010 |
| 1400.080 mm 8 | 1436.080 mm 8 | 1408.075 mm 75 |
| 1400.090 mm 9 | 1438.080 TX 8 | 1408.150 mm 150 |
| 1400.100 mm 10 | 1438.100 TX 10 | 1410.010 |
| 1400.110 mm 11 | 1438.150 TX 15 | 1412.010 |
| 0351.090 mm 1,5-2-2,5-3-4-5-6-8-10 | | |
| 0366.090 TX 10-15-20-25-27-30-40-45-50 | | |





				
1815.090	370 x 188 x 30	1442	8011578815240	144,10
1815.092	vuoto - empty	50	8011578815264	18,00

1815.095 MODULO 82 INSERTI
 MODULE 82 BITS



Contenuto-content:

- | | | |
|-------------------|--------------------|--------------------|
| 0249.400 mm 4x25 | 0255.300 TX 30x25 | 0263.950 mm 5x50 |
| 0249.500 mm 5x25 | 0255.400 TX 40x25 | 0263.960 mm 6x50 |
| 0249.600 mm 6x25 | 0263.015 mm 1.5x25 | 0245.100 PH 1x75 |
| 0250.100 PH 1x25 | 0263.020 mm 2x25 | 0245.200 PH 2x75 |
| 0250.200 PH 2x25 | 0263.025 mm 2.5x25 | 0245.109 PH 1x90 |
| 0250.300 PH 3x25 | 0263.030 mm 3x25 | 0245.209 PH 2x90 |
| 0251.100 PZ 1x25 | 0263.040 mm 4x25 | 0246.100 PZ 1x75 |
| 0251.200 PZ 2x25 | 0263.050 mm 5x25 | 0246.109 PZ 1x90 |
| 0251.300 PZ 3x25 | 0263.060 mm 6x25 | 0246.200 PZ 2x75 |
| 0253.060 TX 6x25 | 1420.010 | 0246.209 PZ 2x90 |
| 0253.070 TX 7x25 | 0084.010 | 1407.010 |
| 0253.080 TX 8x25 | 0250.910 PH 1x25 T | 0258.910 PZ 1x50 T |
| 0253.090 TX 9x25 | 0250.920 PH 2x25 T | 0258.920 PZ 2x50 T |
| 0253.100 TX 10x25 | 0250.930 PH 3x25 T | 0258.910 PZ 1x50 T |
| 0253.150 TX 15x25 | 0251.910 PZ 1x25 T | 0258.920 PZ 2x50 T |
| 0253.200 TX 20x25 | 0251.920 PZ 2x25 T | 0255.906 TX 6x50 |
| 0253.250 TX 25x25 | 0251.930 PZ 3x25 T | 0255.907 TX 7x50 |
| 0253.270 TX 27x25 | 0258.100 PZ 1x50 | 0255.908 TX 8x50 |
| 0253.300 TX 30x25 | 0258.200 PZ 2x50 | 0255.909 TX 9x50 |
| 0255.060 TX 6x25 | 0258.300 PZ 3x50 | 0255.910 TX 10x50 |
| 0255.070 TX 7x25 | 0260.100 PH 1x50 | 0255.915 TX 15x50 |
| 0255.080 TX 8x25 | 0260.200 PH 2x50 | 0255.920 TX 20x50 |
| 0255.090 TX 9x25 | 0260.300 PH 3x50 | 0255.925 TX 25x50 |
| 0255.100 TX 10x25 | 0262.400 mm 4x50 | 0255.927 TX 27x50 |
| 0255.150 TX 15x25 | 0262.500 mm 5x50 | 0255.930 TX 30x50 |
| 0255.200 TX 20x25 | 0262.600 mm 6x50 | 0255.940 TX 40x50 |
| 0255.250 TX 25x25 | 0263.930 mm 3x50 | |
| 0255.270 TX 27x25 | 0263.940 mm 4x50 | |





				
1815.095	370 x 188 x 30	900	8011578969448	123,80
1815.096	vuoto - empty	57	8011578969462	18,00

1815.100 MODULO 24 BUSSOLE 1/2"
 MODULE 24 SOCKETS 1/2"



Contenuto-content:

- | | | | |
|----------|-------|----------|--------|
| 1500.080 | mm 8 | 1500.240 | mm 24 |
| 1500.090 | mm 9 | 1500.270 | mm 27 |
| 1500.100 | mm 10 | 1500.300 | mm 30 |
| 1500.110 | mm 11 | 1500.320 | mm 32 |
| 1500.120 | mm 12 | 1505.010 | |
| 1500.130 | mm 13 | 1508.125 | mm 125 |
| 1500.140 | mm 14 | 1508.250 | mm 250 |
| 1500.150 | mm 15 | 1510.010 | |
| 1500.160 | mm 16 | 1512.010 | |
| 1500.170 | mm 17 | | |
| 1500.180 | mm 18 | | |
| 1500.190 | mm 19 | | |
| 1500.200 | mm 20 | | |
| 1500.210 | mm 21 | | |
| 1500.220 | mm 22 | | |

				
1815.100	370 x 188 x 30	3500	8011578815288	166,80
1815.102	vuoto - empty	54	8011578815301	18,00

1815.105 MOD. 24 BUSSOLE 1/2" in POLLICI
 MOD. 24 SOCKETS 1/2" in INCH

1/2"



Contenuto-content:

- | | | | |
|----------|---------|----------|--|
| 1504.010 | 3/8" | 1510.010 | |
| 1504.020 | 7/16" | 1512.010 | |
| 1504.030 | 1/2" | 1525.010 | |
| 1504.040 | 9/16" | 1525.015 | |
| 1504.050 | 5/8" | | |
| 1504.060 | 19/32" | | |
| 1504.070 | 11/16" | | |
| 1504.080 | 3/4" | | |
| 1504.090 | 25/32" | | |
| 1504.100 | 13/16" | | |
| 1504.110 | 7/8" | | |
| 1504.120 | 15/16" | | |
| 1504.130 | 1" | | |
| 1504.140 | 1.1/16" | | |
| 1504.150 | 1.1/8" | | |
| 1504.160 | 1.3/16" | | |
| 1504.170 | 1.1/4" | | |
| 1505.010 | | | |
| 1508.125 | mm 125 | | |
| 1508.250 | mm 250 | | |





				
1815.105	370 x 188 x 30	3500	8011578962524	193,05

1815.120 MOD. 4 MART. MAZZUOLA SCALPELLI
 MOD. 4 HAMMERS - MALLET - CHISELS



Contenuto-content:

- | | |
|----------|--------|
| 0377.030 | gr 300 |
| 0370.035 | mm 35 |
| 0616.015 | mm 150 |
| 0612.016 | mm 160 |





				
1815.120	370 x 188 x 30	1170	8011578815325	58,70
1815.122	vuoto - empty	52	8011578815349	18,00

1815.140 MODULO 5 PINZE
 MODULE 5 PLIERS



Contenuto-content:

- | | | | |
|----------|--------|----------|--------|
| 0440.918 | mm 180 | 0474.025 | mm 250 |
| 0412.916 | mm 160 | 0490.024 | mm 240 |
| 0463.916 | mm 160 | | |



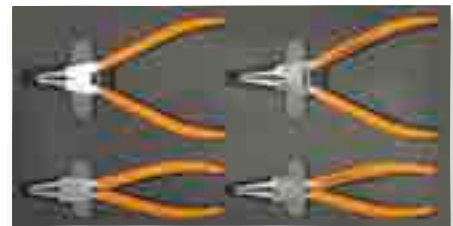

				
1815.140	370 x 188 x 30	1600	8011578815363	88,25
1815.142	vuoto - empty	48	8011578815387	18,00

1815.150 MODULO 4 PINZE ANELLI
 MODULE 4 CIRCLIP PLIERS



Contenuto-content:

- | | | | |
|----------|--------|----------|--------|
| 0505.018 | mm 180 | 0510.018 | mm 180 |
| 0506.017 | mm 170 | 0511.017 | mm 170 |

				
1815.150	370 x 188 x 30	1620	8011578815400	66,25
1815.152	vuoto - empty	68	8011578815424	18,00





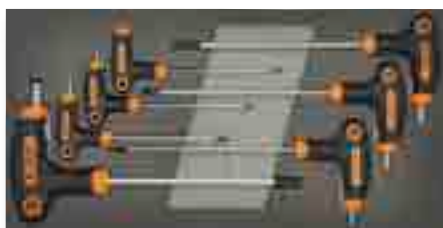

1815.180 MODULO 7 CHIAVI "T" IMPUGNATURA
 MODULE 7 "T" HANDLE WRENCHES



Contenuto-content:

0344.020 mm 2 0344.050 mm 5
 0344.025 mm 2,5 0344.060 mm 6
 0344.030 mm 3 0344.080 mm 8
 0344.040 mm 4





				
1815.180	370 x 188 x 30	546	8011578815448	47,95
1815.182	vuoto - empty	61	8011578815462	18,00

1815.220 MODULO 8 CHIAVI PIPA
 MOD. 8 ANGLE OPEN WRENCHES



Contenuto-content:

1098.080 mm 8 1098.130 mm 13
 1098.090 mm 9 1098.140 mm 14
 1098.100 mm 10 1098.170 mm 17
 1098.110 mm 11 1098.190 mm 19



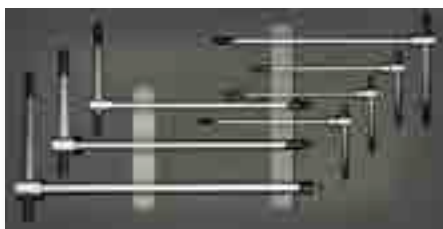

				
1815.220	370 x 188 x 30	1596	8011578815523	96,05
1815.222	vuoto - empty	60	8011578815547	18,00

1815.200 MOD. 7 CHIAVI TRE TESTE ESAGONO
 MOD. 7 THREE HEAD HEX. WRENCHES



Contenuto-content:

0344.320 mm 2 0344.340 mm 4 0344.380 mm 8
 0344.325 mm 2,5 0344.350 mm 5
 0344.330 mm 3 0344.360 mm 6

				
1815.200	370 x 188 x 30	658	8011578815486	100,15
1815.202	vuoto - empty	46	8011578815509	18,00

1815.240 MOD. 8 CHIAVI CRICCHETTO REVERS.
 MOD. 8 REV. RATCHET WRENCHES



Contenuto-content:

1060.080 mm 8 1060.130 mm 13
 1060.100 mm 10 1060.140 mm 14
 1060.110 mm 11 1060.170 mm 17
 1060.120 mm 12 1060.190 mm 19



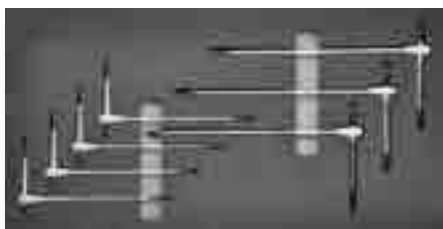

				
1815.240	370 x 188 x 30	992	8011578815561	147,50
1815.242	vuoto - empty	46	8011578815585	18,00

1815.210 MODULO 7 CHIAVI TRE TESTE TORX
 MOD. 7 TORX THREE H. WRENCHES



Contenuto-content:

0344.408 TX 8 0344.420 TX 20 0344.430 TX 30
 0344.410 TX 10 0344.425 TX 25
 0344.415 TX 15 0344.427 TX 27





				
1815.210	370 x 188 x 30	348	8011578949648	103,25
1815.212	vuoto - empty	68	8011578949662	18,00

1815.260 MOD. 8 CHIAVI CRICCHETTO SNOD.
 MOD. 8 FLEX RATCHET WRENCHES



Contenuto-content:

1055.080 mm 8 1055.130 mm 13
 1055.100 mm 10 1055.140 mm 14
 1055.110 mm 11 1055.170 mm 17
 1055.120 mm 12 1055.190 mm 19





				
1815.260	370 x 188 x 30	1132	8011578815608	139,60
1815.262	vuoto - empty	46	8011578815622	18,00

1815.300

MOD. 4 CESCOIA FORB. SCALP. CHIAVE
 MOD. 4 SNIPS-SCIS.-WRENCH-CHISEL



Contenuto-content:
 0560.025 mm 250 1070.020 mm 200
 0683.010 0620.010





				
1815.300	370 x 188 x 30	1400	8011578815646	83,10
1815.302	vuoto - empty	50	8011578815660	18,00

1815.330

MODULO 5 LIME
 MODULE 5 FILES



Contenuto-content:
 0574.090
 0574.190
 0574.290
 0574.390
 0574.490

				
1815.330	370 x 188 x 30	900	8011578969400	62,15
1815.332	vuoto - empty	57	8011578969424	18,00

1815.380

MOD. GRANDE 4 CHIAVI A "T" SNOD.
 MOD. BIG 4 "T" CARD. WRENCHES

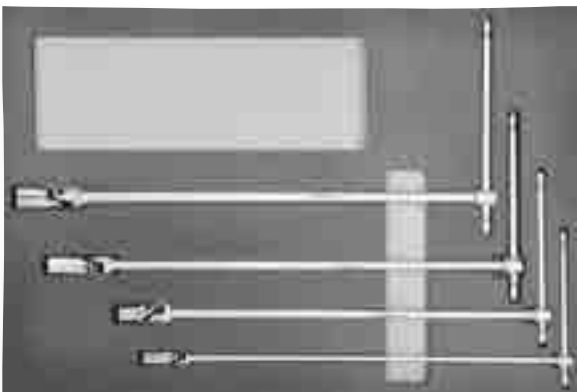

Contenuto-content:
 1150.080 mm 8 1150.130 mm 13
 1150.100 mm 10 1150.170 mm 17



				
1815.380	370 x 550 x 30	1700	8011578815684	170,50
1815.382	vuoto - empty	200	8011578815707	40,00

1815.400

MODULO 8 CHIAVI "T" SNODATE
 MODULE 8 "T" CARD. WRENCHES



Contenuto-content:
 1150.070 mm 7
 1150.080 mm 8
 1150.100 mm 10
 1150.120 mm 12
 1150.130 mm 13
 1150.140 mm 14
 1150.170 mm 17
 1150.190 mm 19



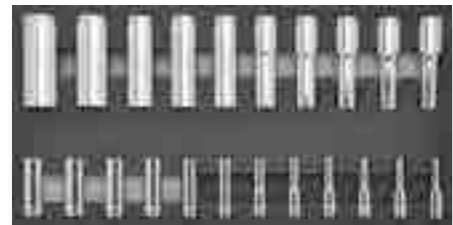

				
1815.400	370 x 550 x 30	3200	8011578969486	321,00
1815.402	vuoto - empty	200	8011578969509	40,00

1815.500

MOD. 22 CHIAVI BUSSOLA 1/4" - 1/2"
 MOD. 22 SOCKETS 1/4" - 1/2"



Contenuto-content:
 1402.040 4
 1402.045 4,5
 1402.050 5
 1402.055 5,5
 1402.060 6
 1402.070 7
 1402.080 8
 1402.090 9
 1402.100 10
 1402.110 11
 1402.120 12
 1402.130 13
 1502.100 10
 1502.110 11
 1502.120 12
 1502.130 13
 1502.140 14
 1502.150 15
 1502.170 17
 1502.190 19
 1502.220 22
 1502.240 24

				
1815.500	370 x 188 x 30	1770	8011578949686	114,50
1815.502	vuoto - empty	57	8011578949709	18,00





1815.540

MOD. 39 BUSS. TORX-ES. 1/4" - 1/2"
 MOD. 39 TORX-HEX SOCKETS 1/4" - 1/2"



Contenuto-content:

1436.030 mm 3	1534.200 TX 20	1535.100 10
1436.040 mm 4	1534.250 TX 25	1535.120 12
1436.050 mm 5	1534.270 TX 27	1535.140 14
1436.060 mm 6	1534.300 TX 30	1535.160 16
1436.080 mm 8	1534.400 TX 40	1535.180 18
1438.080 TX 8	1534.450 TX 45	1535.200 20
1438.100 TX 10	1534.500 TX 50	1535.240 24
1438.150 TX 15	1404.040 E 4	1530.040 4
1438.200 TX 20	1404.050 E 5	1530.050 5
1438.250 TX 25	1404.060 E 6	1530.060 6
1438.270 TX 27	1404.070 E 7	1530.080 8
1438.300 TX 30	1404.080 E 8	1530.100 10
1438.400 TX 40	1404.100 E 10	1530.120 12

	←-L-→			€
1815.540	370 x 188 x 30	1788	8011578949723	168,80
1815.542	vuoto - empty	66	8011578949747	18,00

1815.580

MODULO 20 BUSS. ES-TX-XZN 1/2"
 MOD. 20 HEX-TX-XZN SOCKETS 1/2"

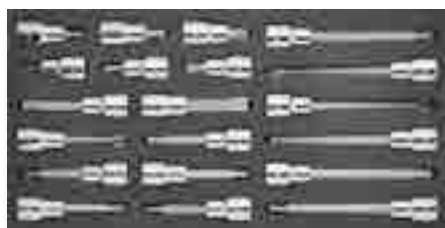

Contenuto-content:

1531.050 5	1537.040 M 4
1531.060 6	1537.050 M 5
1531.080 8	1537.060 M 6
1531.206 6	1537.080 M 8
1531.208 8	1537.100 M 10
1531.210 10	1537.120 M 12
1534.840 TX 40	
1534.845 TX 45	
1534.850 TX 50	
1534.855 TX 55	
1534.860 TX 60	
1534.940 TX 40	
1534.950 TX 50	
1534.955 TX 55	

	←-L-→			€
1815.580	370 x 188 x 30	2306	8011578949761	159,05
1815.582	vuoto - empty	57	8011578949785	18,00



1815.590

MODULO 18 BUSSOLE IMPACT
 MODULE 18 IMPACT SOCKETS



Contenuto-content:

1650.120 mm 12
1650.130 mm 13
1650.140 mm 14
1650.150 mm 15
1650.160 mm 16
1650.170 mm 17
1650.180 mm 18
1650.190 mm 19
1650.210 mm 21
1650.220 mm 22
1650.240 mm 24
1650.270 mm 27
1652.130 mm 13
1652.170 mm 17
1652.190 mm 19
1652.220 mm 22
1652.240 mm 24
1653.012

	←-L-→			€
1815.590	370 x 188 x 30	2300	8011578969523	151,10
1815.592	vuoto - empty	57	8011578969547	18,00



1815.595

MODULO 7 UTENSILI ISOLATI
 MODULE 7 INSULATED TOOLS







Contenuto-content:

0710.018 mm. 180
0716.016 mm. 160
0090.310 3,0 x 100
0090.410 4,0 x 100
0090.615 6,5 x 150
0092.110 PH 1 x 100
0092.210 PH 2 x 100

	←-L-→			€
1815.595	370 x 188 x 30	800	8011578969561	97,15
1815.596	vuoto - empty	57	8011578969585	18,00

1820 FLESSOMETRO - gommato
 TAPE RULE - rubber



					€
1820.030	mt. 3 x 16	126	12	8011578920005	3,50
1820.050	mt. 5 x 19	188	12	8011578920029	5,80

1820.912 ESPOSITORE IN CARTONE 12 FLESSOMETRI
 CARTON DESK DISPLAY 12 TAPE RULES



Contenuto-content:
 1820.030 Nr. 6
 1820.050 Nr. 6

					€
1820.912	280 x 190 x 80	2300		8011578949129	55,80

1821 FLESSOMETRO PROFESSIONALE
 TAPE RULE PROFESSIONAL

LARGHEZZA NASTRO mm 25

- gommato-cromato / rubber-chromed
- 2 pulsanti / 2 buttons
- doppia lettura su due lati nastro / double side
- nastro rivestito in nylon antigraffio / nylon coated tape
- gancio doppio / double hook



pulsante
button

pulsante
button





nastro rivestito in nylon antigraffio
 nylon coated tape



gancio doppio
 double hook



doppia lettura su due lati
 double side

					€
1821.050	mt. 5 x 25	280	6	8011578970826	11,15
1821.080	mt. 8 x 25	430	6	8011578970840	16,10



1844 CUTTER GUIDA IN FERRO - con 3 lame mm 18
 CUTTER - with 3 blades mm 18



1844.010 180 116 12 8011578932237 € 4,40

1844.900 ESPOSITORE IN CARTONE 12 CUTTER
 CARTON DESK DISPLAY 12 CUTTERS



Contenuto-content:
 1844.010 Nr. 12

1844.900 200 x 140 x 90 1250 8011578945640 € 52,80

1845 LAMA PER CUTTER mm 18
 BLADE FOR CUTTER mm 18

prezzo per una lama
 price for one blade



1845.010 18 6 10 8011578932268 € 0,12

1847 CUTTER PROFESSIONALE - con 5 lame con vite di bloccaggio lama - mm 18
 CUTTER PROFESSIONAL - with 5 blades and stop security screw - mm 18

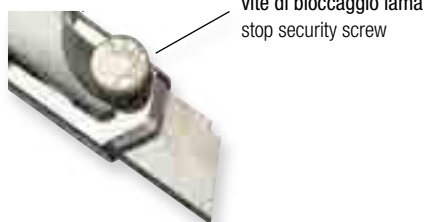

1847.010 18 135 12 8011578970864 € 6,75

punto vendita - sales point
mundial merchandising
 esposizione a libero servizio - self-service exhibition

Utensili in confezione appendibile self-service con codice a barre
Bar code for hanged self-service packaging

Model	Size	Barcode	Price
0050.307-9	3,0 x 75	8011578955007	3,30
0050.310-9	3,0 x 100	8011578955038	3,55
0050.410-9	4,0 x 100	8011578955090	4,50
0050.412-9	4,0 x 125	8011578955120	4,75
0050.510-9	5,5 x 100	8011578955151	4,80
0050.512-9	5,5 x 125	8011578955182	4,95
0050.515-9	5,5 x 150	8011578955212	5,10
0050.610-9	6,5 x 100	8011578955243	5,90
0050.612-9	6,5 x 125	8011578955274	6,20
0050.615-9	6,5 x 150	8011578955304	6,55
0050.815-9	8,0 x 150	8011578955335	8,40
0050.820-9	8,0 x 200	8011578955366	9,25
0050.920-9	10,0 x 200	8011578955387	11,95
0051.256-9	2,5 x 60	8011578955397	3,85
0051.310-9	3,0 x 100	8011578955427	4,20
0051.412-9	4,0 x 125	8011578955458	4,70
0051.415-9	4,0 x 150	8011578955489	5,10
0051.515-9	5,0 x 150	8011578955540	5,35



Model	Size	Barcode	Price
0053.315-9	PZ 3 x 150-8	8011578955939	8,60
0055.403-9	5,0 x 38	8011578955960	4,35
0055.603-9	6,5 x 38	8011578955991	4,45
0056.103-9	PH 1 x 38-4,5	8011578956028	4,35
0056.203-9	PH 2 x 38-6	8011578956059	4,45
0057.103-9	PZ 1 x 38-4,5	8011578956080	4,45
0057.203-9	PZ 2 x 38-6	8011578956110	4,55
0058.330-9	3,0 x 300	8011578956141	6,05
0058.430-9	4,0 x 300	8011578956172	6,95
0058.440-9	4,0 x 400	8011578956240	8,00
0058.530-9	5,0 x 300	8011578956202	7,75
0058.630-9	6,0 x 300	8011578956233	10,00
0058.640-9	6,0 x 400	8011578956257	10,80
0059.030-9	PH 0 x 300-3	8011578956264	5,45
0059.130-9	PH 1 x 300-5	8011578956295	7,55
0059.140-9	PH 1 x 400	8011578956332	7,80
0059.230-9	PH 2 x 300-6	8011578956325	10,00
0059.240-9	PH 2 x 400	8011578956349	10,95
0072.060-9	TX 6 x 60	8011578956516	4,00
0072.070-9	TX 7 x 60	8011578956547	4,00
0072.080-9	TX 8 x 60	8011578956578	4,00
0072.090-9	TX 9 x 60	8011578956608	4,80
0072.100-9	TX 10 x 80	8011578956639	4,90
0072.150-9	TX 15 x 80	8011578956660	4,90
0072.200-9	TX 20 x 100	8011578956691	5,10
0072.250-9	TX 25 x 100	8011578956721	5,30
0072.270-9	TX 27 x 100	8011578956752	5,30
0072.300-9	TX 30 x 100	8011578956783	6,85
0072.400-9	TX 40 x 125	8011578956813	9,05
0072.450-9	TX 45 x 125	8011578956844	9,05
0075.060-9	TX 6 x 60	8011578956875	4,40
0075.070-9	TX 7 x 60	8011578956905	4,40
0075.080-9	TX 8 x 60	8011578956936	4,40
0075.090-9	TX 9 x 60	8011578956967	5,05
0075.100-9	TX 10 x 80	8011578956998	5,15





Model	Size	Barcode	Price
0075.150-9	TX 15 x 80	8011578957025	5,15
0075.200-9	TX 20 x 100	8011578957056	5,30
0075.250-9	TX 25 x 100	8011578957087	5,65
0075.270-9	TX 27 x 100	8011578957117	5,65
0075.300-9	TX 30 x 100	8011578957148	7,20
0075.400-9	TX 40 x 125	8011578957179	9,50
0075.450-9	TX 45 x 125	8011578957209	9,50
0078.025-9	2,5 x 75	8011578957216	3,45
0078.030-9	3 x 75	8011578957230	3,45
0078.040-9	4 x 100	8011578957261	4,50
0078.050-9	5 x 100	8011578957292	4,50
0078.060-9	6 x 125	8011578957322	5,80
0080.100-9	SQ 1 x 100	8011578957353	4,70
0080.200-9	SQ 2 x 125	8011578957384	5,75
0080.300-9	SQ 3 x 150	8011578957414	7,85
0082.050-9	mm. 5	8011578957445	9,25
0082.055-9	mm. 5,5	8011578957476	9,25
0082.060-9	mm. 6	8011578957506	9,25
0082.070-9	mm. 7	8011578957537	10,25
0082.080-9	mm. 8	8011578957568	11,00
0082.090-9	mm. 9	8011578957599	11,60
0082.100-9	mm. 10	8011578957629	11,60
0082.110-9	mm. 11	8011578957660	12,35
0082.120-9	mm. 12	8011578957691	12,35
0082.130-9	mm. 13	8011578957721	12,95
0082.140-9	mm. 14	8011578957752	12,95
0084.010-9	1/4"	8011578957783	6,95
0084.310-9	1/4"	8011578958444	10,35
0087.010-9	1/4"	8011578957803	10,60
0087.310-9		8011578952686	15,30
0090.258-9	2,5 x 80	8011578957834	4,90
0090.310-9	3,0 x 100	8011578957865	5,30
0090.410-9	4,0 x 100	8011578957896	6,05
0090.512-9	5,5 x 125	8011578957926	7,10
0090.615-9	6,5 x 150	8011578957957	9,05









Model	Size	Barcode	Price
0052.006-9	PH 0 x 60-3	8011578955571	3,30
0052.010-9	PH 0 x 100-3	8011578955601	3,55
0052.108-9	PH 1 x 80-4,5	8011578955632	4,45
0052.112-9	PH 1 x 125-4,5	8011578955663	5,05
0052.210-9	PH 2 x 100-6	8011578955694	5,80
0052.215-9	PH 2 x 150-6	8011578955724	6,65
0052.315-9	PH 3 x 150-8	8011578955755	8,40
0053.006-9	PZ 0 x 60-3	8011578955786	3,40
0053.108-9	PZ 1 x 80-4,5	8011578955816	4,55
0053.112-9	PZ 1 x 125-4,5	8011578955847	5,15
0053.210-9	PZ 2 x 100-6	8011578955878	6,30
0053.215-9	PZ 2 x 150-6	8011578955908	6,75

Utensili in confezione appendibile self-service con codice a barre

Bar code for hanged self-service packaging







			€
0090.817-9	8,0 x 175	8011578957988	11,80
0092.007-9	PH 0 x 75	8011578958015	4,30
0092.110-9	PH 1 x 100	8011578958046	6,10
0092.210-9	PH 2 x 100	8011578958077	8,15
0092.315-9	PH 3 x 150	8011578958107	11,10
0093.007-9	PZ 0 x 75	8011578958138	4,75
0093.110-9	PZ 1 x 100	8011578958169	7,05
0093.210-9	PZ 2 x 100	8011578958190	8,70
0093.315-9	PZ 3 x 150	8011578958220	11,90
0115.206-9	mm. 2 x 60	8011578115104	2,50
0115.256-9	mm. 2,5 x 60	8011578115159	2,60
0115.307-9	mm. 3 x 75	8011578115197	2,30
0115.310-9	mm. 3 x 100	8011578115203	2,40
0115.410-9	mm. 4 x 100	8011578115289	2,65
0115.512-9	mm. 5 x 125	8011578115333	2,85
0115.612-9	mm. 6 x 125	8011578115425	3,60
0115.615-9	mm. 6 x 150	8011578115449	3,70
0115.815-9	mm. 8 x 150	8011578115456	4,65
0115.920-9	mm. 10 x 200	8011578115609	7,60
0116.002-9	PH 00-2 x 60	8011578116064	2,50
0116.006-9	PH 0-3 x 60	8011578116088	2,35
0116.010-9	PH 0-3 x 100	8011578116095	2,45
0116.108-9	PH 1-4,5 x 80	8011578116101	2,80
0116.112-9	PH 1-4,5 x 125	8011578116156	2,90
0116.210-9	PH 2-6 x 100	8011578116200	3,60
0116.215-9	PH 2-6 x 150	8011578116224	3,75
0116.315-9	PH 3-8 x 150	8011578116309	4,70
0130.307-9	mm. 3 x 75	8011578130053	2,60
0130.310-9	mm. 3 x 100	8011578130060	2,65
0130.410-9	mm. 4 x 100	8011578130107	3,10
0130.412-9	mm. 4 x 125	8011578130152	3,15
0130.510-9	mm. 5 x 100	8011578130206	3,30
0130.512-9	mm. 5 x 125	8011578130237	3,30
0130.515-9	mm. 5 x 150	8011578130251	3,45
0130.610-9	mm. 6 x 100	8011578130305	4,00
0130.612-9	mm. 6 x 125	8011578130329	4,10
0130.615-9	mm. 6 x 150	8011578130336	4,25
0130.815-9	mm. 8 x 150	8011578130404	5,70
0132.310-9	3 x 100	8011578132095	2,65
0132.415-9	4 x 150	8011578132125	3,30
0132.515-9	5 x 150	8011578132255	3,45
0135.006-9	PH 0-3 x 60	8011578135065	2,65
0135.010-9	PH 0-3 x 100	8011578135096	2,70
0135.108-9	PH 1-4,5 x 80	8011578135102	3,35
0135.112-9	PH 1-4,5 x 125	8011578135157	3,50
0135.210-9	PH 2-6 x 100	8011578135201	4,15
0135.215-9	PH 2-6 x 150	8011578135256	4,40
0135.315-9	PH 3-8 x 150	8011578135300	5,80
0136.006-9	PZ 0-3 x 60	8011578136093	3,30
0136.108-9	PZ 1-4,5 x 80	8011578136109	4,05
0136.112-9	PZ 1-4,5 x 125	8011578136130	4,20
0136.210-9	PZ 2-6 x 100	8011578136154	5,50
0136.215-9	PZ 2-6 x 150	8011578136185	5,90
0136.315-9	PZ 3-8 x 150	8011578136208	7,50
0137.140-9	4 x 30	8011578137052	2,95
0137.160-9	6 x 30	8011578137083	3,15
0137.210-9	PH 1-4,5 x 30	8011578137106	3,00
0137.220-9	PH 2-6 x 30	8011578137137	3,15
0137.310-9	PZ 1-4,5 x 30	8011578137151	3,95
0137.320-9	PZ 2-6 x 30	8011578137182	4,20
0138.325-9	3 x 250	8011578138035	4,60
0138.430-9	4 x 300	8011578138103	5,60
0138.630-9	6 x 300	8011578138202	6,70
0139.025-9	PH 0-3 x 250	8011578139032	5,35
0139.130-9	PH 1-4,5 x 300	8011578139094	6,15
0139.230-9	PH 2-6 x 300	8011578139124	7,05
0162.105-9	1,5 x 50	8011578162030	2,90
0162.206-9	2 x 50	8011578162054	2,90
0162.210-9	2,5 x 50	8011578162078	2,90
0162.310-9	3 x 50	8011578162122	2,90
0163.005-9	PH 000-2 x 50	8011578163037	2,90
0163.006-9	PH 00-2 x 50	8011578163075	2,90

			€
0163.015-9	PH 0-3 x 50	8011578163105	2,90
0163.904-9		8011578985240	2,90
0163.905-9		8011578985288	2,90
0163.906-9	TX 6	8011578163204	2,90
0163.907-9	TX 7	8011578163228	2,90
0163.908-9	TX 8	8011578163242	2,90
0163.909-9	TX 9	8011578163266	2,90
0163.910-9	TX 10	8011578163280	2,90
0163.915-9	TX 15	8011578163303	2,90
0163.920-9	TX 20	8011578163334	2,90
0170.307-9		8011578977856	2,60
0170.410-9		8011578977870	2,75
0170.510-9		8011578977894	3,15
0170.612-9		8011578977900	3,70
0172.007-9		8011578977924	2,60
0172.110-9		8011578977948	3,15
0172.210-9		8011578977962	3,60
0173.110-9		8011578977986	3,25
0173.210-9		8011578977993	3,60
0184.307-9	mm. 3 x 75	8011578184100	1,95
0184.407-9	mm. 4 x 75	8011578184155	2,40
0184.510-9	mm. 5 x 100	8011578184209	2,50
0184.612-9	mm. 6 x 125	8011578184254	2,70
0186.006-9	PH 0-3 x 60	8011578186005	1,95
0186.108-9	PH 1-4,5 x 80	8011578186050	2,40
0186.210-9	PH 2-6 x 100	8011578186104	2,70
0188.108-9	PZ 1-4,5 x 80	8011578188108	2,50
0188.210-9	PZ 2-6 x 100	8011578188153	2,80
0206.060-9	PH 2-6 x 60	8011578206000	2,60
0222.410-9	mm. 4 X 100	8011578222000	3,90
0223.306-9	mm. 3 x 60	8011578223007	3,60
0225.410-9	mm. 4 x 100	8011578225001	2,80
0232.306-9	mm. 3 x 60	8011578232016	2,50
0238.010-9	1/4"	8011578238070	8,80
0239.010-9	1/4"	8011578239077	7,90
0240.005-9	1/4" mm. 50	8011578240073	3,85
0240.010-9	1/4" mm. 75	8011578240059	5,10
0240.020-9	1/4" mm. 100	8011578240066	6,25
0240.030-9	1/4" mm. 150	8011578975609	11,20
0240.040-9	1/4" mm. 200	8011578240080	13,30
0241.014-9	1/4"	8011578241100	1,95
0241.038-9	3/8"	8011578241209	2,35
0241.120-9	1/2"	8011578241223	3,05
0243.060-9	6	8011578243012	3,25
0243.070-9	7	8011578243036	3,25
0243.080-9	8	8011578243050	3,25
0243.100-9	10	8011578243074	3,45
0243.110-9	11	8011578243098	3,65
0243.120-9	12	8011578243111	3,65
0243.130-9	13	8011578243135	4,20
0243.170-9	17	8011578243166	6,00
0243.380-9	3/8"	8011578243142	3,85
0244.045-9	mm. 4 x 100	8011578244002	4,50
0244.055-9	mm. 5 x 100	8011578244026	4,50
0244.065-9	mm. 6 x 100	8011578244040	4,50
0244.075-9	mm. 7 x 100	8011578244064	4,50
0244.085-9	mm. 8 x 100	8011578244088	4,50
0244.105-9	mm. 10 x 100	8011578244101	4,95
0244.125-9	mm. 12 x 100	8011578244125	5,25
0244.135-9	mm. 13 x 100	8011578244149	5,75
0245.100-9	PH 1 x 75	8011578245054	1,90
0245.109-9	PH 1 x 90	8011578245122	2,50
0245.115-9	PH 1 x 150	8011578245146	3,70
0245.200-9	PH 2 x 75	8011578245108	1,90
0245.209-9	PH 2 x 90	8011578245160	2,50
0245.215-9	PH 2 x 150	8011578245184	3,70
0246.100-9	PZ 1 x 75	8011578246051	1,90
0246.109-9	PZ 1 x 90	8011578246129	2,50
0246.115-9	PZ 1 x 150	8011578246143	3,70
0246.200-9	PZ 2 x 75	8011578246105	1,90
0246.209-9	PZ 2 x 90	8011578246167	2,50
0246.215-9	PZ 2 x 150	8011578246181	3,70

			€
0249.400-9	4 x 25 - pz 3	8011578249052	2,50
0249.500-9	5 x 25 - pz 3	8011578249106	2,50
0249.600-9	6 x 25 - pz 3	8011578249151	2,50
0250.100-9	PH 1 x 25 - pz 3	8011578250058	2,50
0250.200-9	PH 2 x 25 - pz 3	8011578250102	2,50
0250.300-9	PH 3 x 25 - pz 3	8011578250157	2,50
0250.810-9	PH 1 x 25 - pz 3 T.8011578250171	8011578250171	3,25
0250.820-9	PH 2 x 25 - pz 3 T.8011578250188	8011578250188	3,25
0250.910-9	PH 1 T. - pz 3	8011578250003	4,30
0250.920-9	PH 2 T. - pz 3	8011578250065	4,30
0250.930-9	PH 3 T. - pz 3	8011578250089	4,30
0251.100-9	PZ 1 x 25 - pz 3	8011578251055	2,50
0251.200-9	PZ 2 x 25 - pz 3	8011578251109	2,50
0251.300-9	PZ 3 x 25 - pz 3	8011578251154	2,50
0251.810-9	PZ 1 x 25 - pz 3 T.8011578251147	8011578251147	3,25
0251.820-9	PZ 2 x 25 - pz 3 T.8011578251161	8011578251161	3,25
0251.910-9	PZ 1 T. - pz 3	8011578251079	4,30
0251.920-9	PZ 2 T. - pz 3	8011578251093	4,30
0251.930-9	PZ 3 T. - pz 3	8011578251123	4,30
0253.060-9	TX 6x25 - pz 3	8011578253004	2,65
0253.070-9	TX 7x25 - pz 3	8011578253011	2,65
0253.080-9	TX 8x25 - pz 3	8011578253035	2,65
0253.090-9	TX 9x25 - pz 3	8011578253066	2,65
0253.100-9	TX 10x25 - pz 3	8011578253097	2,65
0253.150-9	TX 15x25 - pz 3	8011578253127	2,65
0253.200-9	TX 20x25 - pz 3	8011578253158	2,65
0253.250-9	TX 25x25 - pz 3	8011578253189	2,65
0253.270-9	TX 27x25 - pz 3	8011578253219	2,65
0253.300-9	TX 30x25 - pz 3	8011578253240	2,65
0253.400-9	TX 40x25 - pz 3	8011578253264	2,65
0255.060-9	TX 6x25 - pz 3	8011578255015	3,40
0255.070-9	TX 7x25 - pz 3	8011578255039	3,40
0255.080-9	TX 8x25 - pz 3	8011578255053	3,40
0255.090-9	TX 9x25 - pz 3	8011578255060	3,40
0255.100-9	TX 10x25 - pz 3	8011578255091	3,40
0255.150-9	TX 15x25 - pz 3	8011578255121	3,40
0255.200-9	TX 20x25 - pz 3	8011578255152	3,40
0255.250-9	TX 25x25 - pz 3	8011578255183	3,40
0255.270-9	TX 27x25 - pz 3	8011578255213	3,40
0255.300-9	TX 30x25 - pz 3	8011578255243	3,40
0255.400-9	TX 40x25 - pz 3	8011578255275	3,40
0255.906-9	TX 6x50 - pz 3	8011578255282	4,75
0255.907-9	TX 7x50 - pz 3	8011578255305	4,75
0255.908-9	TX 8x50 - pz 3	8011578255329	4,75
0255.909-9	TX 9x50 - pz 3	8011578255343	4,75
0255.910-9	TX 10x50 - pz 3	8011578255367	4,75
0255.915-9	TX 15x50 - pz 3	8011578255381	4,75
0255.920-9	TX 20x50 - pz 3	8011578255404	4,75
0255.925-9	TX 25x50 - pz 3	8011578255428	4,75
0255.927-9	TX 27x50 - pz 3	8011578255442	4,75

Utensili in confezione appendibile self-service con codice a barre

Bar code for hanged self-service packaging

		€			€			€			
0260.820-9	PH 2x50 - pz 3 T.	8011578260248	5,20	0318.070-9	7	8011578318055	8,40	0344.360-9	mm. 6	8011578344764	13,70
0260.910-9	PH 1x50 - pz 3 T.	8011578260187	7,15	0318.080-9	8	8011578318079	8,40	0344.380-9	mm. 8	8011578344801	17,40
0260.920-9	PH 2x50 - pz 3 T.	8011578260200	7,15	0318.090-9	9	8011578318093	8,60	0344.391-9	mm. 10	8011578344849	20,15
0262.400-9	4 x 50 - pz 3	8011578262051	3,40	0318.100-9	10	8011578340109	9,40	0344.392-9	mm. 12	8011578344863	25,25
0262.500-9	5 x 50 - pz 3	8011578262105	3,40	0318.110-9	11	8011578318116	9,50	0344.394-9	mm. 14	8011578344900	30,50
0262.600-9	6 x 50 - pz 3	8011578262150	3,40	0318.120-9	12	8011578318123	9,70	0344.406-9	TX 6	8011578344009	12,30
0263.015-9	1.5 x 25 - pz 3	8011578263010	2,50	0318.130-9	13	8011578318154	9,70	0344.407-9	TX 7	8011578344023	12,30
0263.020-9	2 x 25 - pz 3	8011578263034	2,50	0318.140-9	14	8011578318178	9,90	0344.408-9	TX 8	8011578344047	12,30
0263.025-9	2.5 x 25 - pz 3	8011578263058	2,50	0340.015-9	1,5	8011578340025	3,05	0344.409-9	TX 9	8011578344061	12,30
0263.030-9	3 x 25 - pz 3	8011578263102	2,50	0340.020-9	2	8011578340032	3,05	0344.410-9	TX 10	8011578344085	12,30
0263.040-9	4 x 25 - pz 3	8011578263201	2,50	0340.025-9	2,5	8011578340056	3,05	0344.415-9	TX 15	8011578344108	12,30
0263.050-9	5 x 25 - pz 3	8011578263256	2,50	0340.030-9	3	8011578340070	3,05	0344.420-9	TX 20	8011578344122	12,30
0263.060-9	6 x 25 - pz 3	8011578263300	2,50	0340.040-9	4	8011578340100	3,40	0344.425-9	TX 25	8011578344146	13,65
0263.930-9	3 x 50 - pz 3	8011578263324	3,70	0340.050-9	5	8011578340117	3,75	0344.427-9	TX 27	8011578344160	13,65
0263.940-9	4 x 50 - pz 3	8011578263348	3,70	0340.060-9	6	8011578340131	4,70	0344.430-9	TX 30	8011578344184	13,65
0263.950-9	5 x 50 - pz 3	8011578263362	3,70	0340.080-9	8	8011578340155	6,10	0344.440-9	TX 40	8011578344221	17,05
0263.960-9	6 x 50 - pz 3	8011578263386	3,70	0341.100-9	SQ 1-4 x 100	8011578341008	4,15	0344.445-9	TX 45	8011578344245	17,05
0270.040-9	mm. 4 x 75	8011578270001	3,00	0341.200-9	SQ 2-5 x 125	8011578341053	4,70	0345.015-9	1,5	8011578345006	1,20
0270.050-9	mm. 5 x 75	8011578270025	3,00	0341.300-9	SQ 3-6 x 150	8011578341084	4,85	0345.020-9	2	8011578345037	1,30
0270.060-9	mm. 6 x 75	8011578270049	3,00	0343.060-9	TX 6	8011578343033	3,00	0345.025-9	2,5	8011578345068	1,35
0270.080-9	mm. 8 x 75	8011578270063	3,00	0343.070-9	TX 7	8011578343057	3,00	0345.030-9	3	8011578345099	1,40
0270.100-9	mm. 10 x 75	8011578270087	3,00	0343.080-9	TX 8	8011578343071	3,10	0345.035-9	3,5	8011578345129	1,45
0272.020-9	TX 20 x 75	8011578272005	3,05	0343.090-9	TX 9	8011578343095	3,15	0345.040-9	4	8011578345150	1,55
0272.025-9	TX 25 x 75	8011578272029	3,05	0343.100-9	TX 10	8011578343101	3,30	0345.045-9	5	8011578345181	1,60
0272.027-9	TX 27 x 75	8011578272043	3,05	0343.150-9	TX 15	8011578343125	3,65	0345.050-9	5	8011578345211	1,70
0272.030-9	TX 30 x 75	8011578272067	3,05	0343.200-9	TX 20	8011578343132	3,65	0345.055-9	5	8011578345242	1,80
0272.040-9	TX 40 x 75	8011578272081	3,05	0343.250-9	TX 25	8011578343156	4,25	0345.060-9	6	8011578345273	1,85
0272.045-9	TX 45 x 75	8011578272104	3,05	0343.270-9	TX 27	8011578343187	4,40	0345.070-9	7	8011578345303	2,10
0272.050-9	TX 50 x 75	8011578272128	3,05	0343.300-9	TX 30	8011578343194	5,10	0345.080-9	8	8011578345334	2,45
0272.055-9	TX 55 x 75	8011578272142	3,05	0343.400-9	TX 40	8011578343217	5,50	0345.090-9	9	8011578345365	3,05
0274.005-9	XZN 5 x 75	8011578274009	3,45	0343.450-9	TX 45	8011578343248	5,65	0345.100-9	10	8011578345396	3,25
0274.006-9	XZN 6 x 75	8011578274023	3,45	0343.605-9	TX 5	8011578343538	3,85	0345.120-9	12	8011578345426	5,20
0274.008-9	XZN 8 x 75	8011578274047	3,45	0343.606-9	TX 6	8011578343552	3,85	0345.130-9	13	8011578345457	5,95
0274.010-9	XZN 10 x 75	8011578274061	3,45	0343.607-9	TX 7	8011578343576	3,85	0345.140-9	14	8011578345488	6,90
0274.012-9	XZN 12 x 75	8011578274085	3,45	0343.608-9	TX 8	8011578343590	3,85	0345.170-9	17	8011578345518	12,20
0275.005-9	RIBE 5 x 75	8011578275129	3,45	0343.609-9	TX 9	8011578343613	3,85	0345.190-9	19	8011578345549	15,90
0275.006-9	RIBE 6 x 75	8011578275143	3,45	0343.610-9	TX 10	8011578343637	3,95	0345.220-9	22	8011578345556	23,10
0275.007-9	RIBE 7 x 75	8011578275167	3,45	0343.615-9	TX 15	8011578343651	4,30	0345.240-9	24	8011578345587	29,25
0275.008-9	RIBE 8 x 75	8011578275181	3,45	0343.620-9	TX 20	8011578343675	4,30	0345.270-9	27	8011578975623	33,90
0275.009-9	RIBE 9 x 75	8011578275204	3,45	0343.625-9	TX 25	8011578343699	4,95	0345.705-9	7,05	8011578981983	1,45
0275.010-9	RIBE 10 x 75	8011578275228	3,45	0343.627-9	TX 27	8011578343705	5,10	0345.708-9	7,08	8011578982003	1,55
0275.012-9	RIBE 12 x 75	8011578275242	3,45	0343.630-9	TX 30	8011578343729	5,75	0345.710-9	7,10	8011578982027	1,65
0276.004-9	3/8"-mm. 10	8011578276003	4,90	0343.640-9	TX 40	8011578343743	6,20	0345.712-9	7,12	8011578982041	1,95
0276.006-9	1/2"-mm. 10	8011578276027	6,35					0345.715-9	7,15	8011578982065	2,05
0278.070-9	mm. 7	8011578278090	8,10					0345.718-9	7,18	8011578982089	2,20
0278.080-9	mm. 8	8011578278113	8,10	0344.020-9	2	8011578344030	3,95	0345.720-9	7,20	8011578982102	2,60
0278.100-9	mm. 10	8011578278151	8,10	0344.025-9	2,5	8011578344078	4,10	0345.723-9	7,23	8011578982157	2,80
0303.110-9	mm. 8 x 95	8011578303037	5,05	0344.030-9	3	8011578344092	4,25	0345.725-9	7,25	8011578982201	3,05
0303.210-9	mm. 8 x 95	8011578303051	5,05	0344.040-9	4	8011578344139	4,65	0345.920-9	2	8011578975647	1,40
0304.110-9	mm. 6 x 90	8011578304034	4,50	0344.050-9	5	8011578344207	5,20	0345.925-9	2,5	8011578975661	1,45
0304.210-9	mm. 6 x 90	8011578304058	4,50	0344.060-9	6	8011578344269	5,90	0345.930-9	3	8011578975685	1,55
0305.110-9	mm. 4 x 65	8011578305031	3,75	0344.080-9	8	8011578344306	6,80	0345.940-9	4	8011578975708	1,70
0305.210-9	mm. 4 x 65	8011578305055	3,75	0344.100-9	10	8011578344344	9,50	0345.950-9	5	8011578345709	2,10
0307.010-9		8011578307004	9,35	0344.200-9	TX 6	8011578344382	4,00	0345.960-9	6	8011578345723	2,40
0310.010-9		8011578310004	10,60	0344.207-9	TX 7	8011578344405	4,00	0345.980-9	8	8011578345747	3,50
0311.010-9		8011578311001	14,10	0344.208-9	TX 8	8011578344429	4,00	0345.981-9	10	8011578345761	5,10
0313.010-9		8011578313005	11,30	0344.209-9	TX 9	8011578344443	4,00				
0316.040-9	4	8011578316037	6,00	0344.210-9	TX 10	8011578344467	4,10				
0316.050-9	5	8011578316051	6,00	0344.215-9	TX 15	8011578344481	4,25	0350.015-9	1,5	8011578350031	1,60
0316.055-9	5,5	8011578316075	6,00	0344.220-9	TX 20	8011578344504	4,67	0350.020-9	2	8011578350055	1,80
0316.060-9	6	8011578316105	6,00	0344.225-9	TX 25	8011578344528	5,45	0350.025-9	2,5	8011578350109	1,90
0316.070-9	7	8011578316129	6,40	0344.230-9	TX 30	8011578344566	5,90	0350.030-9	3	8011578350154	1,95
0316.080-9	8	8011578316150	6,60	0344.240-9	TX 40	8011578344573	7,65	0350.040-9	4	8011578350208	2,20
0316.090-9	9	8011578316181	6,70	0344.320-9	mm. 2	8011578344603	10,70	0350.050-9	5	8011578350253	2,40
0316.100-9	10	8011578316204	7,10	0344.325-9	mm. 2,5	8011578344627	10,70	0350.060-9	6	8011578350307	2,80
0316.110-9	11	8011578316259	7,25	0344.330-9	mm. 3	8011578344641	10,80	0350.080-9	8	8011578350406	3,60
0316.120-9	12	8011578316273	7,60	0344.340-9	mm. 4	8011578344689	11,70	0350.100-9	10	8011578350451	4,20
0316.130-9	13	8011578316303	8,10	0344.350-9	mm. 5	8011578344726	12,05	0355.020-9	2	8011578355050	0,90
0316.140-9	14	8011578316310	8,25					0355.025-9	2,5	8011578355104	0,90
0318.050-9	5	8011578318000	6,80								
0318.055-9	5,5	8011578318017	6,80								
0318.060-9	6	8011578318031	7,00								

Utensili in confezione appendibile self-service con codice a barre

Bar code for hanged self-service packaging



0355.030-9	3	8011578355159	0,90
0355.040-9	4	8011578355258	1,10
0355.050-9	5	8011578355357	1,30
0355.060-9	6	8011578355456	1,50
0355.080-9	8	8011578355609	2,00
0355.100-9	10	8011578355708	2,90
0355.808-9		8011578982546	1,45
0355.810-9		8011578982607	1,50
0355.815-9		8011578982669	1,55
0355.820-9		8011578982720	1,65
0360.060-9	TX 6	8011578360009	1,70
0360.070-9	TX 7	8011578360030	1,70
0360.080-9	TX 8	8011578360061	1,70
0360.090-9	TX 9	8011578360092	1,70
0360.100-9	TX 10	8011578360122	2,10
0360.150-9	TX 15	8011578360153	2,20
0360.200-9	TX 20	8011578360184	2,40
0360.250-9	TX 25	8011578360214	2,50
0360.270-9	TX 27	8011578360245	2,60
0360.300-9	TX 30	8011578360276	2,65
0360.400-9	TX 40	8011578360306	2,70
0360.450-9	TX 45	8011578360337	3,20
0360.500-9	TX 50	8011578360351	3,50
0365.080-9		8011578982768	1,75
0365.100-9		8011578982805	2,15
0365.150-9		8011578982843	2,25
0365.200-9		8011578982881	2,45



0370.022-9	mm. 22	8011578370039	17,60
0370.028-9	mm. 28	8011578370077	19,80
0370.035-9	mm. 35	8011578370091	23,50
0370.042-9	mm. 42	8011578370114	28,70
0370.050-9	mm. 50	8011578370138	37,70
0370.060-9	mm. 60	8011578370152	49,20
0371.022-9	22	8011578371104	4,30
0371.028-9	28	8011578371203	5,10
0371.035-9	35	8011578371302	6,10
0371.042-9	42	8011578371357	8,60
0371.050-9	50	8011578371388	11,70
0371.060-9	60	8011578371500	15,30
0372.030-9	300 Din 200	8011578372101	7,20
0372.050-9	500 Din 400	8011578372156	8,35
0372.080-9	800 Din 600	8011578372200	11,40
0373.030-9	gr. 300	8011578373108	8,35
0373.050-9	gr. 500	8011578373122	9,70
0373.080-9	gr. 800	8011578373153	13,40
0373.905-9	gr. 500	8011578373160	35,00
0373.908-9	gr. 800	8011578373184	55,40
0373.910-9	gr. 1000	8011578373207	68,95
0373.915-9	gr. 1500	8011578373221	103,00
0374.050-9	gr. 500	8011578374006	12,50
0374.060-9	gr. 600	8011578374020	13,55
0374.080-9	gr. 800	8011578374044	15,90
0374.100-9	gr. 1000	8011578374068	18,20
0375.030-9	mm. 30	8011578375003	25,10
0375.035-9	mm. 35	8011578375027	28,25
0375.040-9	mm. 40	8011578375041	31,80
0375.050-9	mm. 50	8011578375065	44,90
0375.060-9	mm. 60	8011578375089	55,65
0376.035-9	mm. 35	8011578376000	28,45
0376.040-9	mm. 40	8011578376024	34,00
0376.050-9	mm. 50	8011578376048	44,00
0376.060-9	mm. 60	8011578376062	55,10
0376.130-9	30	8011578376086	5,05
0376.135-9	35	8011578376109	7,25
0376.140-9	40	8011578376123	8,80
0376.150-9	50	8011578376147	12,70
0376.160-9	60	8011578376161	17,00



0377.010-9	gr. 100	8011578377106	6,85
0377.020-9	gr. 200	8011578377151	7,10
0377.030-9	gr. 300	8011578377205	8,45
0377.040-9	gr. 400	8011578377250	9,75
0377.050-9	gr. 500	8011578377304	10,70
0377.060-9	gr. 600	8011578377359	11,80
0377.080-9	gr. 800	8011578377403	13,05
0377.100-9	gr. 1000	8011578377458	14,50
0377.150-9	gr. 1500	8011578377557	18,55
0377.200-9	gr. 2000	8011578377601	21,75
0378.010-9	gr. 100	8011578378004	2,60
0378.020-9	gr. 200	8011578378059	2,70
0378.030-9	gr. 300	8011578378103	2,90
0378.040-9	gr. 400	8011578378158	3,10
0378.050-9	gr. 500	8011578378202	3,30
0378.060-9	gr. 600	8011578378257	3,50
0378.080-9	gr. 800	8011578378301	3,80
0378.100-9	gr. 1000	8011578378356	4,10
0378.150-9	gr. 1500	8011578378370	4,50
0378.200-9	gr. 2000	8011578378394	4,90
0380.020-9	gr. 200	8011578380106	9,65
0380.030-9	gr. 300	8011578380151	12,25
0380.050-9	gr. 500	8011578380250	14,00
0380.080-9	gr. 800	8011578380304	17,60
0380.100-9	gr. 1000	8011578380359	19,00
0381.030-9	gr. 300	8011578381004	10,35
0382.030-9	gr. 300	8011578382308	11,95
0382.040-9	gr. 400	8011578382353	13,05
0382.210-9	300/400	8011578382506	3,35
0382.925-9	gr. 250	8011578382537	17,40
0382.930-9	gr. 300	8011578382551	18,25
0382.940-9	gr. 400	8011578382575	19,60
0383.080-9	gr. 800	8011578383107	10,95
0383.100-9	gr. 1000	8011578383102	11,80
0383.120-9	gr. 1200	8011578383268	14,35
0383.150-9	gr. 1500	8011578982980	16,35
0383.200-9	gr. 2000	8011578383282	18,45
0383.908-9	FIB gr. 800	8011578383183	14,50
0383.910-9	FIB gr. 1000	8011578383213	16,15
0383.912-9	FIB gr. 1250	8011578383244	16,25
0384.040-9	gr. 400	8011578384005	13,65
0385.040-9	gr. 400	8011578385002	17,30
0385.903-9	gr. 300	8011578385026	12,35
0385.905-9	gr. 500	8011578385040	14,20
0385.908-9	gr. 800	8011578385064	18,45
0385.910-9	gr. 1000	8011578385088	21,20
0386.010-9	gr. 35	8011578386054	12,90
0402.035-9	mm. 350	8011578402013	26,50
0402.045-9	mm. 450	8011578402006	33,90
0402.060-9	mm. 600	8011578402051	47,45
0402.075-9	mm. 750	8011578402105	65,90
0402.090-9	mm. 900	8011578402129	90,50
0403.035-9	mm. 350	8011578403157	15,00
0403.045-9	mm. 450	8011578403003	19,80
0403.060-9	mm. 600	8011578403058	24,95
0403.075-9	mm. 750	8011578403102	34,60
0403.090-9	mm. 900	8011578403126	45,75
0404.020-9	mm. 200	8011578404000	15,75
0405.030-9	mm. 600-12	8011578405007	71,70
0405.035-9	mm. 900-14	8011578405021	87,60
0407.010-9	mm. 190-6	8011578407001	26,00
0408.016-9	mm. 160	8011578408008	12,45
0409.018-9	mm. 180	8011578409005	13,00
0410.016-9	mm. 160	8011578410001	14,90
0412.916-9	mm. 165	8011578412159	11,80
0414.015-9	mm. 150	8011578414009	24,25
0415.016-9		8011578415006	20,35
0415.017-9		8011578983024	26,15
0416.010-9	mm. 150	8011578416003	31,45
0417.020-9	mm. 200	8011578417000	7,65
0417.022-9	mm. 220	8011578417055	8,30
0417.025-9	mm. 250	8011578417109	8,95



0417.028-9	mm. 280	8011578417123	10,60
0418.022-9	mm. 220	8011578418151	11,50
0418.025-9	mm. 250	8011578418205	13,00
0418.028-9	mm. 280	8011578418212	14,60
0420.022-9	mm. 220	8011578420109	12,35
0420.025-9	mm. 250	8011578420154	13,60
0420.028-9	mm. 280	8011578420185	15,20
0423.018-9	mm. 180	8011578423001	12,40
0425.018-9	mm. 180	8011578425050	10,05
0425.020-9	mm. 200	8011578425104	11,20
0430.010-9		8011578430009	20,70
0431.010-9		8011578431006	19,20
0432.010-9		8011578432003	19,40
0433.016-9	mm. 16 - PROF.	8011578433024	39,00
0433.020-9	mm. 20 - PROF.	8011578433048	39,00
0434.016-9	mm. 16	8011578434021	28,55
0434.020-9	mm. 20	8011578434045	28,55
0435.010-9	Ø 6.3	8011578435059	17,75
0436.010-9	Ø 9.3	8011578436056	20,30
0437.010-9		8011578437008	23,00
0440.916-9	mm. 160	8011578440053	11,40
0440.918-9	mm. 180	8011578440107	12,45
0440.920-9	mm. 200	8011578440152	13,70
0441.018-9	mm. 180	8011578441005	17,30
0441.020-9	mm. 200	8011578441029	18,15
0456.016-9	mm. 160	8011578456054	10,40
0456.018-9	mm. 180	8011578456108	10,70
0456.020-9	mm. 200	8011578456153	12,75
0462.016-9	mm. 160	8011578462000	15,90
0462.020-9	mm. 200	8011578462154	16,85
0463.916-9	mm. 170	8011578463151	11,65
0463.920-9	mm. 200	8011578463205	12,90
0466.916-9	mm. 170	8011578466152	12,30
0466.920-9	mm. 200	8011578466206	13,30
0467.916-9	mm. 160	8011578467258	11,50
0469.916-9	mm. 160	8011578469153	13,00
0472.010-9	mm. 240	8011578472009	18,70
0474.014-9	mm. 140	8011578474126	11,90
0474.018-9	mm. 180	8011578474058	16,85
0474.025-9	mm. 250	8011578474102	21,40
0475.025-9		8011578985141	33,85
0476.010-9	mm. 270	8011578476052	28,90
0478.010-9	mm. 280	8011578478100	26,95
0478.910-9	mm. 280	8011578478117	29,80
0479.016-9	mm. 160	8011578479039	12,40
0479.020-9	mm. 220	8011578479077	13,70
0480.010-9	mm. 460	8011578480004	34,40
0482.010-9	mm. 200	8011578482008	15,00
0483.010-9	mm. 250	8011578483005	25,75



0490.018-9	mm. 180	8011578490058	15,35
0490.024-9	mm. 240	8011578490003	17,40
0490.030-9	mm. 300	8011578490010	22,75
0491.024-9	mm. 240	8011578491000	19,95
0491.030-9	mm. 300	8011578491024	23,80
0492.018-9	mm. 180	8011578492007	22,85
0492.024-9	mm. 240	8011578492021	28,35
0492.030-9	mm. 300	8011578492045	34,10
0495.024-9	mm. 240	8011578495053	15,15
0497.024-9		8011578983185	10,45
0500.017-9	mm. 175-1"	8011578500030	18,90
0500.022-9	mm. 225-1-1/2"	8011578500054	24,15
0500.027-9	mm. 270-2"	8011578500078	28,35
0500.030-9	mm. 300-2-1/2"	8011578500092	32,25
0500.035-9	mm. 350-3"	80115785	

Utensili in confezione self-service con codice a barre

Bar code for hanged self-service packaging

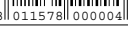
			€
0502.040-9	400 1.1/2"	8011578502157	40,75
0502.054-9	540 2"	8011578502201	65,20
0502.065-9	650 3"	8011578502256	122,05
0502.725-9	250 1/2"	8011578502300	24,60
0502.732-9	320 1"	8011578502324	28,40
0502.740-9	400 1.1/2"	8011578502348	40,75
0502.754-9	540 2"	8011578502362	65,20
0502.765-9	650 3"	8011578502386	122,05
0503.030-9	300 1"	8011578503000	27,55
0503.041-9	410 1.1/2"	8011578503109	39,50
0503.052-9	520 2"	8011578503154	64,70
0503.062-9	620 3"	8011578503208	119,95
0504.020-9	mm. 200-8"	8011578504205	13,65
0504.025-9	mm. 250-10"	8011578504250	17,50
0504.030-9	mm. 300-12"	8011578504304	18,95
0504.035-9	mm. 350-14"	8011578504359	23,25
0504.045-9	mm. 450-18"	8011578504458	30,45
0504.060-9	mm. 600-24"	8011578504601	41,20
0504.090-9	mm. 900-36"	8011578504779	92,65
0504.114-9	mm. 350-14"	8011578504946	31,45
0504.118-9	18"-450	8011578504656	47,70
0504.124-9	24"-600	8011578504670	75,10
0504.136-9	36"-900	8011578504694	138,20
0504.725-9	mm. 250-1-1/2"	8011578504809	15,70
0504.735-9	mm. 350-2"	8011578504823	21,60
0504.745-9	mm. 450-2"-1/2"	8011578504847	29,20
0504.760-9	mm. 600-3"	8011578504861	47,70
0504.790-9	mm. 900-4"	8011578504885	89,40
0504.950-9	mm. 300-4"	8011578504755	36,75
0504.953-9		8011578504960	17,65
0504.960-9	mm. 900-6"	8011578504908	142,30
0504.963-9		8011578983284	34,60
0504.990-9	Ø 90	8011578504922	26,90
0505.014-9	mm. 140	8011578505257	11,65
0505.018-9	mm. 180	8011578505301	12,70
0505.022-9	mm. 220	8011578505356	16,60
0505.032-9	mm. 320	8011578505400	21,25
0506.013-9	mm. 130	8011578506056	12,30
0506.017-9	mm. 170	8011578506100	13,30
0506.021-9	mm. 210	8011578506155	17,55
0506.031-9	mm. 310	8011578506209	22,15
0510.014-9	mm. 140	8011578510053	11,10
0510.018-9	mm. 180	8011578510107	12,15
0510.022-9	mm. 220	8011578510152	16,20
0510.032-9	mm. 320	8011578510206	20,65
0511.013-9	mm. 130	8011578511050	11,65
0511.017-9	mm. 170	8011578511104	12,90
0511.021-9	mm. 210	8011578511159	17,00
0511.031-9	mm. 310	8011578511203	21,75
0513.014-9		8011578983307	14,15
0513.018-9		8011578983321	15,35
0513.022-9		8011578983345	19,55
0514.013-9		8011578983369	14,90
0514.017-9		8011578983383	15,95
0514.021-9		8011578983406	20,65
0515.014-9		8011578983420	13,40
0515.018-9		8011578983444	14,50
0515.022-9		8011578983468	18,70
0516.013-9		8011578983482	14,05
0516.017-9		8011578983505	15,10
0516.021-9		8011578983529	19,80
0518.010-9	mm. 280	8011578518004	16,10
0518.020-9	mm. 280	8011578518011	16,10
0520.010-9	mm. 120	8011578520007	7,20
0522.010-9	mm. 120	8011578522001	7,20
0524.010-9	mm. 120	8011578524005	7,20
0525.010-9	mm. 150	8011578525002	7,30
0526.010-9	mm. 115	8011578526009	7,30
0527.010-9	mm. 115	8011578527006	7,30
0528.010-9	mm. 120	8011578528003	7,30
0532.110-9	mm. 155	8011578532055	4,50
0532.210-9	mm. 155	8011578532109	4,60

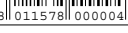
			€
0533.010-9		8011578533007	15,30
0534.010-9		8011578534004	15,30
0540.110-9	mm. 150	8011578540050	4,70
0540.210-9	mm. 150	8011578540104	4,90
0541.210-9	mm. 165	8011578541057	5,70
0552.010-9		8011578552008	10,45
0553.010-9		8011578553005	18,20
0555.010-9		8011578555009	23,45
0555.020-9		8011578555023	37,35
0555.030-9		8011578555047	34,00
0555.040-9		8011578555061	45,10
0555.050-9	80 x 30	8011578555085	35,04
0555.060-9		8011578555108	22,90
0558.010-9		8011578558000	5,40
0559.022-9	mm. 220	8011578559052	20,40
0559.024-9	mm. 240	8011578559106	22,20
0559.026-9	mm. 260	8011578559151	23,80
0559.030-9	mm. 300	8011578559205	28,90
0560.020-9	mm. 200	8011578560058	13,20
0560.025-9	mm. 250	8011578560102	16,05
0560.030-9	mm. 300	8011578560157	20,30
0561.010-9		8011578561000	16,25
0562.010-9		8011578562007	16,25
0563.010-9		8011578563004	16,25
0564.010-9		8011578564001	13,85
0565.010-9		8011578565008	13,85
0566.010-9		8011578566005	13,85
0567.010-9		8011578567019	22,20
0568.010-9		8011578568030	22,20
0569.010-9		8011578569051	20,60
0570.010-9		8011578570002	7,80
0572.010-9		8011578572006	19,65
0574.080-9		8011578574161	8,25
0574.090-9		8011578574017	9,45
0574.100-9		8011578574000	12,60
0574.180-9		8011578574185	9,45
0574.190-9		8011578574031	10,70
0574.200-9		8011578574024	13,45
0574.280-9		8011578574208	8,25
0574.290-9		8011578574055	8,90
0574.300-9		8011578574048	11,00
0574.380-9		8011578574222	8,25
0574.390-9		8011578574116	9,35
0574.400-9		8011578574062	12,25
0574.480-9		8011578574246	8,25
0574.490-9		8011578574079	9,25
0574.500-9		8011578574086	11,90
0574.780-9		8011578574260	8,25
0574.790-9		8011578574192	8,90
0574.800-9		8011578574109	11,60
0575.040-9		8011578575007	8,70
0575.080-9		8011578575021	8,70
0576.060-9	6	8011578576004	8,45
0576.080-9	8	8011578576059	8,60
0576.100-9	10	8011578576103	8,95
0576.120-9	12	8011578576158	9,40
0576.140-9	14	8011578576189	9,80
0576.160-9	16	8011578576196	9,90
0576.180-9	18	8011578576226	10,35
0576.200-9	20	8011578576233	10,50
0576.220-9	22	8011578576257	10,90
0576.250-9	25	8011578576288	11,40
0576.300-9	30	8011578576301	12,65

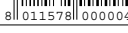

0580.060-9	6	8011578580100	10,10
0580.080-9	8	8011578580155	10,20
0580.100-9	10	8011578580209	10,25
0580.120-9	12	8011578580254	10,40

			€
0580.140-9	14	8011578580308	10,65
0580.160-9	16	8011578580353	10,65
0580.180-9	18	8011578580407	11,50
0580.200-9	20	8011578580452	11,50
0580.220-9	22	8011578580506	11,90
0580.250-9	25	8011578580551	12,25
0580.300-9	30	8011578580605	14,10
0582.060-9	6	8011578582050	
0582.080-9	8	8011578582104	14,65
0582.100-9	10	8011578582159	15,40
0582.120-9	12	8011578582203	16,00
0582.140-9		8011578582258	16,00
0582.160-9	16	8011578582302	17,75
0582.180-9		8011578582357	17,75
0582.200-9	20	8011578582401	19,75
0588.014-9	140	8011578588205	3,55
0589.013-9	130	8011578589257	4,00
0591.010-9	100	8011578591106	2,55
0591.011-9	110	8011578591113	2,80
0591.012-9	120	8011578591120	3,00
0592.010-9	100	8011578592103	2,55
0592.011-9	110	8011578592110	2,80
0592.012-9	120	8011578592127	3,00
0593.910-9		8011578593025	29,20
0594.010-9		8011578594008	14,60
0595.010-9		8011578595005	10,00
0596.010-9		8011578596002	13,50
0597.910-9		8011578597009	12,60
0598.010-9		8011578598006	3,00
0598.910-9		8011578598020	7,65
0599.110-9	pz 12	8011578599010	9,70
0599.210-9	pz 12	8011578599058	8,50
0599.410-9	pz 10	8011578599041	22,70
0600.015-9	mm. 150	8011578600105	10,90
0600.020-9	mm. 200	8011578600204	19,05
0600.025-9	mm. 250	8011578600259	25,95
0600.030-9	mm. 300	8011578600266	35,15
0601.025-9		8011578601003	31,00
0601.030-9		8011578601034	40,20
0601.925-9	mm. 250	8011578601027	5,75
0601.930-9	mm. 300	8011578601041	5,75
0612.013-9	mm. 8 x 125	8011578612009	5,05
0612.016-9	mm. 12 x 150	8011578612054	6,10
0614.013-9	mm. 8 x 125	8011578614058	5,70
0614.016-9	mm. 12 x 150	8011578614102	6,85
0615.100-9	mm. 1-10 x 125	8011578615055	4,45
0615.200-9	mm. 2-10 x 125	8011578615109	4,45
0615.300-9	mm. 3-10 x 125	8011578615154	4,45
0615.400-9	mm. 4-12 x 150	8011578615208	5,30
0615.500-9	mm. 5-12 x 150	8011578615253	5,30
0615.600-9	mm. 6-12 x 150	8011578615307	5,30
0616.012-9	mm. 10 x 120	8011578616052	4,85
0616.015-9	mm. 12 x 150	8011578616106	5,45
0616.910-9		8011578616120	12,65
0617.020-9	mm. 2	8011578617059	4,70
0617.030-9	mm. 3	8011578617073	4,95
0617.040-9	mm. 4	8011578617097	5,00
0617.050-9	mm. 5	8011578617127	5,40
0617.060-9	mm. 6	8011578617134	6,10
0617.080-9	mm. 8	8011578617158	6,55
0624.120-9		8011578609108	4,40
0624.220-9		8011578609153	4,70
0624.225-9		8011578609207	4,75
0624.230-9		8011578609252	5,45
0624.525-9		8011578986063	4,75
0625.025-9	mm. 16 x 250	8011578625054	4,75
0625.030-9	mm. 16 x 300	8011578625108	5,55
0625.035-9	mm. 16 x 350	8011578625153	6,40
0625.040-9	mm. 16 x 400	8011578625207	7,15
0626.025-9	mm. 16 x 250	801157	

Utensili in confezione appendibile self-service con codice a barre

Bar code for hanged self-service packaging



0626.040-9	mm. 16 x 400	8011578626150	7,15
0628.030-9	mm. 16 x 300	8011578628055	9,70
0628.035-9	mm. 16 x 350	8011578628109	10,75
0629.030-9	mm. 16 x 300	8011578629052	9,70
0629.035-9	mm. 16 x 350	8011578629106	10,75
0629.110-9		8011578629151	2,90
0630.030-9	mm. 16 x 300	8011578630003	12,25
0630.035-9	mm. 16 x 350	8011578630058	13,30
0631.030-9	mm. 16 x 300	8011578631000	12,25
0631.035-9	mm. 16 x 350	8011578631055	13,30
0633.050-9	50	8011578633059	12,60
0633.070-9	70	8011578633073	12,80
0638.010-9	gr. 100	8011578638009	4,70
0638.020-9	gr. 200	8011578638108	5,45
0638.030-9	gr. 300	8011578638054	6,65
0638.040-9	gr. 400	8011578638146	7,50
0638.050-9	gr. 500	8011578638153	8,60
0638.080-9	gr. 800	8011578638207	11,60
0640.020-9	gr. 200	8011578640101	8,45
0640.030-9	gr. 300	8011578640156	9,30
0640.040-9	gr. 400	8011578640200	10,15
0640.050-9	gr. 500	8011578640255	11,10
0671.010-9	mm. 400	8011578671006	8,30
0672.010-9	mm. 600	8011578672003	12,25
0677.010-9		8011578977221	21,70
0680.010-9	mm. 145	8011578680008	6,20
0683.010-9	mm. 145	8011578683009	9,40
0686.110-9	mm. 145	8011578686055	7,60
0686.210-9	mm. 145	8011578686086	8,05
0689.010-9		8011578689001	7,30
0700.010-9	mm. 200	8011578700010	16,40
0702.010-9	mm. 450	8011578702106	32,30
0710.018-9	mm. 180	8011578710002	25,60
0710.020-9	mm. 200	8011578710026	30,75
0712.016-9	mm. 160	8011578712044	19,45
0712.020-9	mm. 200	8011578712068	23,35
0714.016-9	mm. 160	8011578714086	19,85
0714.020-9	mm. 200	8011578714109	23,65
0716.016-9	mm. 160	8011578716127	23,80
0739.010-9		8011578739003	15,00
0740.010-9		8011578740009	15,55
0741.020-9	mm. 32-240	8011578741006	186,20
0741.040-9	mm. 52-400	8011578741020	259,70
0741.920-9		8011578741044	163,95
0741.940-9		8011578741068	286,35
0750.010-9		8011578750022	46,80
0751.010-9		8011578751005	46,80
0752.010-9		8011578752002	46,80
0756.010-9		8011578756000	41,20
0769.015-9	mm. 15	8011578769000	19,30
0769.022-9	mm. 22	8011578769024	24,00
0770.022-9	mm. 22	8011578770600	7,95
0772.032-9	mm. 32	8011578772635	16,95
0773.010-9	mm. 42	8011578773007	43,10



0774.032-9	mm. 32	8011578774653	18,30
0775.110-9	18 x 3 rame	8011578775674	1,35
0775.210-9	18 x 3 inox	8011578775698	4,30
0776.063-9	mm. 63	8011578776725	67,00
0776.110-9	18 x 6 rame	8011578776756	1,60
0776.210-9	18 x 6 inox	8011578776787	4,35
0776.310-9	22 x 6 plastica	8011578776817	2,05
0777.127-9	mm. 127	8011578777845	161,60
0777.210-9	42 x 11 plastica	8011578777876	15,50
0782.002-9	mm. 2"	8011578782900	66,70
0782.110-9	31 x 19 acciaio	8011578782931	4,30
0782.210-9	31 x 19 inox	8011578782962	12,60
0786.042-9		8011578786007	44,75



0790.042-9	mm. 42	8011578790998	16,20
0792.042-9	mm. 42	8011578792121	28,30
0792.142-9		8011578792145	6,35
0794.063-9	mm. 63	8011578794156	68,10
0794.163-9		8011578794170	22,80
0795.010-9		8011578795009	16,20
0796.100-9		8011578796198	22,10
0796.300-9		8011578796181	14,90
0797.300-9		8011578797218	29,10
0798.240-9		8011578798246	13,65
0799.010-9		8011578799007	21,20
0815.010-9		8011578815035	50,60
0830.010-9		8011578830021	7,20
0832.010-9		8011578832001	21,45
0833.010-9	pz 10	8011578833008	37,20
0839.010-9		8011578839000	16,05
0840.010-9	1/2" FEMMINA	8011578840006	29,10
0842.010-9	1/2"	8011578970390	15,80
0843.010-9	1/2"	8011578843021	4,20
1020.067-9	6-7	8011578020033	3,20
1020.089-9	8-9	8011578020071	3,55
1020.090-9	8-10	8011578020408	3,95
1020.101-9	10-11	8011578020095	4,05
1020.103-9	10-13	8011578020446	4,30
1020.123-9	12-13	8011578020125	4,35
1020.137-9	13-17	8011578020422	5,15
1020.145-9	14-15	8011578020132	4,85
1020.167-9	16-17	8011578020156	5,20
1020.179-9		8011578985608	6,55
1020.189-9	18-19	8011578020187	6,60
1020.202-9	20-22	8011578020200	7,05
1020.213-9	21-23	8011578020224	8,35
1020.246-9	24-26	8011578020248	10,00
1020.247-9	24-27	8011578020231	10,05
1020.258-9	25-28	8011578020262	11,55
1020.279-9		8011578985622	11,55
1020.302-9	30-32	8011578020286	14,30
1020.326-9	32-36	8011578020309	26,80
1020.361-9	36-41	8011578020323	31,25
1020.416-9	41-46	8011578020347	42,15
1020.465-9	46-50	8011578020361	57,10
1025.067-9	6-7	8011578025021	4,20
1025.089-9	8-9	8011578025052	4,80
1025.101-9	10-11	8011578025076	5,35
1025.123-9	12-13	8011578025106	5,95
1025.145-9	14-15	8011578025120	6,70
1025.167-9	16-17	8011578025137	7,45
1025.189-9	18-19	8011578025151	10,60
1025.202-9	20-22	8011578025182	11,90
1025.213-9	21-23	8011578025205	13,85
1025.246-9	24-26	8011578025311	16,65
1025.247-9	24-27	8011578025250	16,65
1025.258-9	25-28	8011578025274	20,15
1025.302-9	30-32	8011578025298	24,85
1025.364-9	36-41	8011578025304	49,00









1030.055-9	5.5-5.5	8011578030001	3,15
1030.060-9	6-6	8011578030018	3,30
1030.070-9	7-7	8011578030032	3,30
1030.080-9	8-8	8011578030070	3,55
1030.090-9	9-9	8011578030094	3,70
1030.100-9	10-10	8011578030100	3,85
1030.110-9	11-11	8011578030131	4,10
1030.120-9	12-12	8011578030186	4,50
1030.130-9	13-13	8011578030209	4,60
1030.140-9	14-14	8011578030223	4,80
1030.150-9	15-15	8011578030254	5,05
1030.160-9	16-16	8011578030261	5,20



1030.170-9	17-17	8011578030285	5,70
1030.180-9	18-18	8011578030308	7,00
1030.190-9	19-19	8011578030315	7,65
1030.200-9	20-20	8011578030322	8,25
1030.210-9	21-21	8011578030353	9,05
1030.220-9	22-22	8011578030407	10,00
1030.230-9	23-23	8011578030421	11,20
1030.240-9	24-24	8011578030438	11,35
1030.250-9	25-25	8011578030445	13,25
1030.260-9	26-26	8011578030452	13,55
1030.270-9	27-27	8011578030506	14,20
1030.280-9	28-28	8011578030520	16,20
1030.290-9	29-29	8011578030681	16,95
1030.300-9	30-30	8011578030629	16,95
1030.320-9	32-32	8011578030605	18,90
1030.340-9		8011578983680	18,90
1030.360-9	36-36	8011578030650	40,95
1030.410-9	41-41	8011578030674	49,95
1030.460-9	46-46	8011578030704	50,15
1030.500-9	50-50	8011578030728	64,70
1035.005-9	pollici 1/4"	8011578035006	3,95
1035.008-9	pollici 5/16"	8011578035020	4,05
1035.010-9	pollici 3/8"	8011578035044	4,55
1035.020-9	pollici 7/16"	8011578035068	4,80
1035.030-9	pollici 1/2"	8011578035082	5,70
1035.040-9	pollici 9/16"	8011578035105	5,80
1035.050-9	pollici 5/8"	8011578035129	6,15
1035.070-9	pollici 11/16"	8011578035143	6,90
1035.080-9	pollici 3/4"	8011578035167	9,40
1035.100-9	pollici 13/16"	8011578035181	11,85
1035.110-9	pollici 7/8"	8011578035204	13,10
1035.120-9	pollici 15/16"	8011578035228	15,55
1035.130-9	pollici 1"	8011578035242	16,80
1035.140-9	pollici 1.1/16"	8011578035266	19,25
1035.150-9	pollici 1.1/8"	8011578035280	21,75
1035.170-9	pollici 1.1/4"	8011578035303	25,35
1038.080-9	8-8	8011578038007	5,00
1038.100-9	10-10	8011578038021	5,45
1038.110-9	11-11	8011578038045	5,80
1038.120-9	12-12	8011578038069	6,20
1038.130-9	13-13	8011578038083	6,80
1038.140-9	14-14	8011578038106	7,50
1038.150-9	15-15	8011578038120	8,40
1038.170-9	17-17	8011578038144	9,70
1038.190-9	19-19	8011578038168	11,40
1040.080-9	8-8	8011578040000	4,40
1040.100-9	10-10	8011578040024	5,60
1040.110-9	11-11	8011578040048	5,70
1040.120-9	12-12	8011578040062	6,00
1040.130-9	13-13	8011578040086	6,05
1040.140-9	14-14	8011578040109	6,70
1040.150-9	15-15	8011578040123	6,90
1040.170-9	17-17	8011578040147	7,65
1040.190-9	19-19	8011578040161	8,15
1040.220-9	22-22	8011578040185	10,50
1040.240-9	24-24	8011578040208	12,40
1040.270-9	27-27	8011578040222	13,55
1040.300-9	30-30	8011578040246	16,25
1040.320-9	32-32	8011578040260	16,35
1040.550-9	55-55	8011578040321	114,15
1040.600-9	60-60	8011578040345	146,75
1040.650-9	65-65	8011578040383	200,70
1040.700-9	70-70	8011578040369	319,80
1040.750-9	75-75	8011578040406	354,65
1040.800-9	80-80	8011578040420	405,20
1040.850-9	85-85	8011578040444	464,75
1048.068-9	TX E6 x E8	8011578048006	2,80
1048.102-9	TX E10 x E12	8011578048020	3,35
1048.148-9	TX E14 x E18	8011578048044	5,45
1048.204-9	TX E20 x E24	8011578048068	9,20
1051.080-9	8 x 10		



Utensili in confezione self-service con codice a barre



Bar code for hanged self-service packaging



		€			€			€			
1051.101-9	10 x 11	8011578051143	10,35	1074.050-9	mm. 50	8011578074142	82,65	1078.243-9	24 x 30	8011578078324	6,05
1051.113-9	11 x 13	8011578051167	10,80	1074.055-9	mm. 55	8011578074166	118,55	1078.273-9	27 x 30	8011578078348	6,25
1051.124-9	12 x 14	8011578051181	10,90	1074.060-9	mm. 60	8011578074180	156,15	1078.302-9	30 x 32	8011578078300	7,35
1051.179-9	17 x 19	8011578051204	13,55	1074.065-9	mm. 65	8011578074203	190,75	1078.363-9	36 x 41	8011578078362	13,00
1051.192-9	19 x 22	8011578051228	17,40	1074.070-9	mm. 70	8011578074227	207,05	1078.416-9	41 x 46	8011578078461	20,60
1051.224-9	22 x 24	8011578051242	19,65	1074.946-9	mm. 460	8011578074241	39,75	1078.465-9	46 x 50	8011578078485	25,70
1051.247-9	24 x 27	8011578051266	19,80	1074.961-9	mm. 610	8011578074265	55,65	1078.505-9	50 x 55	8011578078508	38,40
1051.302-9	30 x 32	8011578051280	41,10	1074.976-9	mm. 760	8011578074289	95,95	1078.556-9	55 x 60	8011578078522	43,65
1052.212-9	21-22	8011578052100	14,15	1074.986-9	mm. 860	8011578075026	113,05	1078.808-9		8011578984083	1,90
1053.212-9		8011578053000	21,60	1075.024-9	mm. 24	8011578075262	13,70	1078.810-9		8011578984106	2,20
1055.080-9	8	8011578055103	12,40	1075.027-9	mm. 27	8011578075286	15,80	1078.812-9		8011578984120	2,40
1055.090-9	9	8011578055127	13,00	1075.030-9	mm. 30	8011578075309	16,50	1079.006-9	mm. 6	8011578079000	1,60
1055.100-9	10	8011578055141	13,25	1075.032-9	mm. 32	8011578075002	22,00	1079.007-9	mm. 7	8011578079024	1,60
1055.110-9	11	8011578055165	13,60	1075.036-9	mm. 36	8011578075026	27,90	1079.008-9	mm. 8	8011578079048	1,60
1055.120-9	12	8011578055189	15,00	1075.041-9	mm. 41	8011578075040	32,10	1079.009-9	mm. 9	8011578079062	1,65
1055.130-9	13	8011578055202	15,15	1075.046-9	mm. 46	8011578075064	40,80	1079.010-9	mm. 10	8011578079086	1,65
1055.140-9	14	8011578055226	17,00	1075.050-9	mm. 50	8011578075088	53,70	1079.011-9	mm. 11	8011578079680	1,70
1055.150-9	15	8011578055240	18,55	1075.055-9	mm. 55	8011578075101	69,70	1079.012-9	mm. 12	8011578079420	1,70
1055.160-9	16	8011578055264	18,70	1075.060-9	mm. 60	8011578075125	89,70	1079.013-9	mm. 13	8011578079109	1,75
1055.170-9	17	8011578055288	19,70	1075.065-9	mm. 65	8011578075149	122,70	1079.015-9	mm. 15	8011578079444	2,00
1055.180-9	18	8011578055301	19,90	1075.070-9	mm. 70	8011578075163	130,70	1079.017-9	mm. 17	8011578079123	2,20
1055.190-9	19	8011578055325	21,10	1075.075-9	mm. 75	8011578075177	150,15	1079.019-9	mm. 19	8011578079147	2,35
1058.080-9		8011578983765	9,50	1075.080-9	mm. 80	8011578075187	287,20	1079.022-9	mm. 22	8011578079161	3,10
1058.100-9		8011578983802	10,25	1075.085-9	mm. 85	8011578075194	292,85	1079.023-9	mm. 23	8011578079703	3,10
1058.130-9		8011578983840	11,60	1075.090-9	mm. 90	8011578075200	405,70	1079.024-9	mm. 24	8011578079185	3,55
1058.170-9		8011578983888	14,35	1075.095-9	mm. 95	8011578075224	418,70	1079.027-9	mm. 27	8011578079208	4,40
1058.190-9		8011578983925	15,35	1075.100-9	mm. 100	8011578075248	443,70	1079.030-9	mm. 30	8011578079222	5,25
1060.080-9	8	8011578060053	13,15	1076.024-9	mm. 24	8011578076009	14,60	1079.032-9	mm. 32	8011578079246	6,25
1060.090-9	9	8011578060077	13,80	1076.027-9	mm. 27	8011578076023	14,70	1079.034-9	mm. 34	8011578079468	7,10
1060.100-9	10	8011578060091	14,00	1076.030-9	mm. 30	8011578076047	15,70	1079.036-9	mm. 36	8011578079260	8,45
1060.110-9	11	8011578060114	14,40	1076.032-9	mm. 32	8011578076061	16,55	1079.038-9	mm. 38	8011578079482	8,50
1060.120-9	12	8011578060138	15,90	1076.036-9	mm. 36	8011578076085	19,20	1079.041-9	mm. 41	8011578079284	14,20
1060.130-9	13	8011578060152	16,05	1076.041-9	mm. 41	8011578076108	24,70	1079.042-9	mm. 42	8011578079505	14,40
1060.140-9	14	8011578060176	18,05	1076.046-9	mm. 46	8011578076122	27,70	1079.046-9	mm. 46	8011578079307	16,90
1060.150-9	15	8011578060190	19,70	1076.050-9	mm. 50	8011578076146	37,90	1079.050-9	mm. 50	8011578079321	19,90
1060.160-9	16	8011578060213	19,80	1076.055-9	mm. 55	8011578076160	51,70	1079.055-9	mm. 55	8011578079345	23,90
1060.170-9	17	8011578060237	20,85	1076.060-9	mm. 60	8011578076184	61,20	1079.060-9	mm. 60	8011578079369	36,30
1060.180-9	18	8011578060251	22,30	1076.065-9	mm. 65	8011578076207	83,70	1079.065-9	mm. 65	8011578079383	44,20
1060.190-9	19	8011578060275	22,70	1076.070-9	mm. 70	8011578076221	107,70	1079.070-9	mm. 70	8011578079406	73,70
1060.220-9	22	8011578060299	32,15	1076.075-9	mm. 75	8011578076238	116,45	1079.075-9	mm. 75	8011578079529	88,70
1060.240-9	24	8011578060312	37,40	1076.080-9	mm. 80	8011578076245	159,70	1079.080-9	mm. 80	8011578079543	103,70
1065.080-9	mm. 8	8011578068004	7,10	1076.085-9	mm. 85	8011578076252	191,50	1079.085-9	mm. 85	8011578079567	123,70
1065.100-9	mm. 10	8011578068028	8,10	1076.090-9	mm. 90	8011578076269	223,30	1079.090-9	mm. 90	8011578079581	129,70
1065.130-9	mm. 13	8011578068042	8,80	1076.095-9	mm. 95	8011578076283	250,70	1079.095-9	mm. 95	8011578079604	194,70
1065.170-9	mm. 17	8011578068066	11,25	1076.100-9	mm. 100	8011578076306	260,70	1079.100-9	mm. 100	8011578079642	260,70
1065.190-9	mm. 19	8011578068080	12,90	1076.105-9	mm. 105	8011578076320	349,70	1079.105-9	mm. 105	8011578079659	283,70
1067.080-9	mm. 8	8011578067021	8,10	1076.110-9	mm. 110	8011578076344	366,40	1079.110-9	mm. 110	8011578079727	348,70
1067.100-9	mm. 10	8011578067045	8,70	1076.115-9	mm. 115	8011578076368	380,20	1079.115-9	mm. 115	8011578079741	386,55
1067.130-9	mm. 13	8011578067069	9,75	1076.120-9	mm. 120	8011578076382	487,25	1079.120-9	mm. 120	8011578079765	442,70
1067.170-9	mm. 17	8011578067083	13,60	1076.125-9	mm. 125	8011578076405	488,30	1079.125-9	mm. 125	8011578079789	469,70
1067.190-9	mm. 19	8011578067106	14,80	1076.130-9	mm. 130	8011578076429	626,10	1079.130-9	mm. 130	8011578079802	497,70
1069.104-9	MM 10-1/4"	8011578069001	5,80	1076.135-9	mm. 135	8011578076443	690,70	1079.135-9	mm. 135	8011578079826	525,40
1069.138-9	MM 13-3/8"	8011578069025	6,70	1076.140-9	mm. 140	8011578076467	759,70	1079.808-9		8011578984182	1,60
1069.192-9	MM 19-1/2"	8011578069049	7,80	1077.025-9		8011578077006	2,80	1079.810-9		8011578984205	1,75
1069.914-9	MM 10-1/4" BIT	8011578069063	5,35	1078.067-9	6 x 7	8011578078003	1,45	1079.813-9		8011578984229	2,05
1070.015-9	150	8011578070151	11,35	1078.078-9	7 x 8	8011578078027	1,55	1079.817-9		8011578984243	2,60
1070.020-9	200	8011578070205	14,05	1078.083-9	8 x 9	8011578078041	1,75	1079.819-9		8011578984267	3,15
1070.025-9	250	8011578070250	20,45	1078.085-9	8 x 10	8011578078065	1,75	1080.067-9	mm. 6-7	8011578080068	2,35
1070.030-9	300	8011578070304	25,30	1078.101-9	10 x 11	8011578078089	1,80	1080.089-9	mm. 8-9	8011578080082	2,50
1070.037-9	375	8011578070328	53,95	1078.103-9	10 x 13	8011578078102	1,75	1080.101-9	mm. 10-11	8011578080105	2,55
1070.045-9	450	8011578070342	85,15	1078.123-9	12 x 13	8011578078126	1,80	1080.123-9	mm. 12-13	8011578080129	2,75
1071.015-9	mm. 150	8011578071004	13,40	1078.137-9	13 x 17	8011578078140	2,10	1080.145-9	mm. 14-15	8011578080143	2,90
1071.020-9	mm. 200	8011578071028	15,55	1078.145-9	14 x 15	8011578078409	2,50	1080.167-9	mm. 16-17	8011578080167	2,95
1071.025-9	mm. 250	8011578071042	22,95	1078.167-9	16 x 17	8011578078423	2,60	1080.189-9	mm. 18-19	8011578080181	3,10
1071.030-9	mm. 300	8011578071066	28,25	1078.175-9	17 x 19	8011578078164	2,75	1080.202-9	mm. 20-22	8011578080204	3,50
1074.024-9	mm. 24	8011578074005	29,10	1078.177-9	17 x 22	8011578078188	3,25	1080.246-9	mm. 24-26	8011578080242	3,80
1074.027-9	mm. 27	8011578074029	33,55	1078.189-9	18 x 19	8011578078447	3,00	1080.258-9	mm. 25-28	8011578080259	4,30
1074.030-9	mm. 30	8011578074043	38,35	1078.192-9	19 x 22	8011578078201	3,25	1080.302-9	mm. 30-32	8011578080303	4,85
1074.032-9	mm. 32	8011578074067	44,55	1078.194-9	19 x 24	8011578078225	3,80	1080.555-9	mm. 55-55	8011578080501	8,60
1074.036-9	mm. 36	8011578074081	53,50	1078.202-9	20 x 22	8011578078249	3,85	1090.060-9	mm. 6-6	8011578090067	3,20
1074.041-9	mm. 41	8011578074104	63,45	1078.224-9	22 x 24	8011578078263	4,30	1090.070-9	mm. 7-7	8011578090074	3,20
1074.046-9	mm. 46	8011578074128	74,25	1078.242-9	24 x 27	8011578078287	5,40	1090.080-9	mm. 8-8	8011578090081	3,30

Utensili in confezione appendibile self-service con codice a barre

Bar code for hanged self-service packaging







		€
1090.090-9	mm. 9-9	8011578090098 3,30
1090.100-9	mm. 10-10	8011578090104 3,60
1090.110-9	mm. 11-11	8011578090111 4,00
1090.120-9	mm. 12-12	8011578090128 4,10
1090.130-9	mm. 13-13	8011578090135 4,65
1090.140-9	mm. 14-14	8011578090142 4,65
1090.150-9	mm. 15-15	8011578090159 5,00
1090.160-9	mm. 16-16	8011578090166 5,00
1090.170-9	mm. 17-17	8011578090173 5,60
1090.190-9	mm. 19-19	8011578090197 5,65
1090.200-9	mm. 20-20	8011578090203 5,80
1090.220-9	mm. 22-22	8011578090227 6,30
1092.067-9	6 x 7	8011578092054 3,00
1092.089-9	8 x 9	8011578092078 3,15
1092.101-9	10 x 11	8011578092092 3,65
1092.123-9	12 x 13	8011578092115 4,20
1092.145-9	14 x 15	8011578092139 4,45
1092.167-9	16 x 17	8011578092153 4,90
1092.189-9	18 x 19	8011578092177 6,05
1092.202-9	20 x 22	8011578092191 7,30
1092.213-9	21 x 23	8011578092214 7,95
1092.246-9	24 x 26	8011578092238 9,90
1092.258-9	25 x 28	8011578092252 11,35
1092.279-9	27 x 29	8011578092276 11,65
1092.302-9	30 x 32	8011578092290 11,90
1096.067-9	6 x 7	8011578096052 11,70
1096.089-9	8 x 9	8011578096076 12,65
1096.101-9	10 x 11	8011578096090 13,10
1096.123-9	12 x 13	8011578096113 15,20
1096.145-9	14 x 15	8011578096137 18,15
1096.167-9	16 x 17	8011578096151 19,55
1096.189-9	18 x 19	8011578096175 24,25
1096.202-9	20 x 22	8011578096199 25,65
1097.910-9	5-8-10	8011578097073 6,85
1097.912-9	12 x 250	8011578097127 4,65
1097.914-9	14 x 320	8011578097080 5,15
1097.919-9	19 x 400	8011578097103 10,80
		
1098.060-9	6	8011578098056 7,45
1098.070-9	7	8011578098070 7,45
1098.080-9	8	8011578098094 7,45
1098.090-9	9	8011578098117 4,45
1098.100-9	10	8011578098131 7,70
1098.110-9	11	8011578098155 8,55
1098.120-9	12	8011578098179 9,15
1098.130-9	13	8011578098193 9,85
1098.140-9	14	8011578098216 10,85
1098.150-9	15	8011578098230 13,10
1098.160-9	16	8011578098254 14,40
1098.170-9	17	8011578098278 15,05
1098.180-9	18	8011578098292 15,50
1098.190-9	19	8011578098315 16,75
1098.200-9	20	8011578098339 20,00
1098.210-9	21	8011578098353 20,90
1098.220-9	22	8011578098377 20,95
1098.230-9	23	8011578098391 26,90
1098.240-9	24	8011578098414 26,95
1098.270-9	27	8011578098438 34,30
1098.300-9	30	8011578098452 41,60
1098.320-9	32	8011578098476 41,60
1150.060-9	mm. 6	8011578001032 28,70
1150.070-9	mm. 7	8011578001063 28,70
1150.080-9	mm. 8	8011578001094 28,70
1150.090-9	mm. 9	8011578001124 29,70
1150.100-9	mm. 10	8011578001155 29,70
1150.110-9	mm. 11	8011578001186 34,20
1150.120-9	mm. 12	8011578001216 34,20
1150.130-9	mm. 13	8011578001247 34,20
1150.140-9	mm. 14	8011578001278 40,70

		€
1150.150-9	mm. 15	8011578001308 40,70
1150.160-9	mm. 16	8011578001339 40,70
1150.170-9	mm. 17	8011578001360 40,70
1150.180-9	mm. 18	8011578001391 49,70
1150.190-9	mm. 19	8011578001421 49,70
1150.200-9	mm. 20	8011578001452 49,70
1150.210-9	mm. 21	8011578001483 49,70
1150.220-9	mm. 22	8011578001513 49,70
1150.240-9	mm. 24	8011578001575 49,70
1152.030-9	mm. 3	8011578001506 29,70
1152.040-9	mm. 4	8011578001520 29,70
1152.050-9	mm. 5	8011578001544 29,70
1152.060-9	mm. 6	8011578001568 32,70
1152.080-9	mm. 8	8011578001537 35,70
1153.020-9	TX 20	8011578115302 35,70
1153.025-9	TX 25	8011578115319 35,70
1153.027-9	TX 27	8011578975746 35,70
1153.030-9	TX 30	8011578975760 39,20
1153.040-9	TX 40	8011578975784 39,20
1153.045-9	TX 45	8011578115357 40,70
1155.005-9	1/4"	8011578001612 36,20
1155.010-9	3/8"	8011578001599 38,70
1155.020-9	1/2"	8011578001988 49,70
1158.140-9	14	8011578005009 46,70
1158.160-9	16	8011578001551 51,70
1158.200-9	21	8011578001605 68,20
1170.016-9	16	8011578117009 8,05
1170.021-9	21	8011578117023 8,05
1325.070-9	7	8011578001681 7,60
1325.080-9	8	8011578001728 7,70
1325.100-9	10	8011578001780 8,90
1325.120-9	12	8011578001841 10,75
1325.130-9	13	8011578001872 10,85
1328.060-9	mm. 6	8011578004064 13,80
1328.070-9	mm. 7	8011578004071 13,80
1328.080-9	mm. 8	8011578004088 13,80
1328.090-9	mm. 9	8011578004095 13,80
1328.100-9	mm. 10	8011578004101 16,15
1328.110-9	mm. 11	8011578004118 16,15
1328.120-9	mm. 12	8011578004125 19,40
1328.130-9	mm. 13	8011578004132 19,40
1328.140-9	mm. 14	8011578004149 24,70
1328.150-9	mm. 15	8011578004156 24,70
1328.160-9	mm. 16	8011578004163 30,70
1328.170-9	mm. 17	8011578004170 30,80
1328.180-9	mm. 18	8011578004187 31,10
1328.190-9	mm. 19	8011578004194 31,10
1328.220-9	mm. 22	8011578004224 40,60
1328.240-9	mm. 24	8011578004248 43,05
1334.270-9	27 x 30	8011578901646 30,80
1334.272-9	27 x 32	8011578976040 30,80
1334.303-9	30 x 33	8011578901684 30,80
1334.910-9	19 x 400	8011578901707 10,55
1336.179-9	17x19x22x1/2"	8011578976026 13,65
1336.247-9	24x27x32x3/4"	8011578901622 57,60
1338.050-9	mm. 500	8011578133801 19,60
1339.010-9	mm. 20	8011578133900 14,95
1345.250-9	250 x 120	8011578345600 33,20
1345.300-9	300 x 140	8011578345624 45,35
1345.400-9	400 x 120	8011578345648 47,70
1345.500-9	500 x 120	8011578345662 50,70
1345.600-9	600 x 120	8011578345686 55,20
1347.250-9	250 x 120	8011578347024 55,20
1347.300-9	300 x 140	8011578347048 77,85
1347.400-9	400 x 120	8011578347062 78,40
1347.500-9	500 x 120	8011578347086 81,90
1348.007-9	mm. 75	8011578348007 16,60
1348.010-9	mm. 100	8011578348021 20,85
1348.015-9	mm. 100	8011578984649 34,10
1350.035-9	15-35	8011578350000 16,25
1350.050-9	35-50	8011578350017 29,45
1350.080-9	50-80	8011578350024 36,20

		€
1350.120-9	80-120	8011578350048 49,00
1350.180-9	120-180	8011578350062 68,20
1351.035-9		8011578984489 20,35
1351.050-9		8011578984526 34,90
1351.080-9		8011578984564 42,35
1351.120-9		8011578984601 57,10
1351.180-9		8011578984687 80,60
1352.028-9	25-28	8011578352004 5,70
1352.032-9	30-32	8011578352028 5,70
1352.036-9	34-36	8011578352066 7,90
1352.042-9	40-42	8011578352080 7,90
1352.050-9	45-50	8011578352103 10,60
1352.055-9	52-55	8011578352127 10,60
1352.062-9	58-62	8011578352141 14,80
1352.075-9	68-75	8011578352165 14,80
1352.090-9	80-90	8011578352189 21,35
1352.100-9	98-100	8011578352202 21,35
1352.115-9	110-115	8011578352226 31,45
1352.130-9	120-130	8011578352240 31,45
1352.145-9	135-145	8011578352264 46,20
1352.165-9	155-165	8011578352288 46,20
1352.195-9	180-195	8011578352301 73,95
1352.220-9	205-220	8011578352325 73,95
1360.011-9	110	8011578360368 11,70
1360.015-9	155	8011578360382 12,70
1360.211-9	110	8011578360405 3,10
1360.215-9	155	8011578360429 3,20
1362.015-9	1/2" 115	8011578362003 54,20
1363.015-9	115	8011578363000 74,00
1364.010-9	60-140	8011578364007 16,90
1366.010-9	8 x 10	8011578360375 8,45
1370.101-9		8011578370169 12,40
1383.010-9		8011578383343 60,95
1385.010-9		8011578385033 21,60
1386.010-9		8011578386061 17,95
1388.038-9	mm. 38	8011578388065 36,35
1388.055-9	mm. 55	8011578388089 38,80
1391.010-9		8011578972028 21,00
1400.040-9	mm. 4	8011578002039 2,20
1400.045-9	mm. 4.5	8011578002046 2,20
1400.050-9	mm. 5	8011578002060 2,20
1400.055-9	mm. 5.5	8011578002084 2,20
1400.060-9	mm. 6	8011578002091 2,20
1400.070-9	mm. 7	8011578002121 2,20
1400.080-9	mm. 8	8011578002145 2,25
1400.090-9	mm. 9	8011578002169 2,25
1400.100-9	mm. 10	8011578002183 2,35
1400.110-9	mm. 11	8011578002206 2,40
1400.120-9	mm. 12	8011578002213 2,50
1400.130-9	mm. 13	8011578002244 2,60
1402.040-9	LUNGA mm. 4	8011578140205 3,10
1402.045-9	LUNGA mm. 4.5	8011578140229 3,10
1402.050-9	LUNGA mm. 5	8011578140250 3,10
1402.055-9	LUNGA mm. 5.5	8011578140267 3,10
1402.060-9	LUNGA mm. 6	8011578140281 3,10
1402.070-9	LUNGA mm. 7	8011578140304 3,10
1402.080-9	LUNGA mm. 8	8011578140328 3,10
1402.090-9	LUNGA mm. 9	8011578140342 3,25
1402.100-9	LUNGA mm. 10	8011578140366 3,25
1402.110-9	LUNGA mm. 11	8011578140380 3,60
1402.120-9	LUNGA mm. 12	8011578140403 3,75
1402.130-9	LUNGA mm. 13	8011578140427 3,75
1402.140-9	LUNGA mm. 14	8011578140243 4,35
1404.040-9	TX E 4 FEM	8011578140441 3,35
1404.050-9	TX	

Utensili in confezione appendibile self-service con codice a barre

Bar code for hanged self-service packaging

		€			€			€
1406.010-9	1/4"	14,60	1500.160-9	mm. 16	3,75	1505.910-9	1/2"	46,55
1407.010-9	1/4"-1/4"	16,05	1500.170-9	mm. 17	4,15	1506.010-9	1/2"	21,35
1408.075-9	mm. 75	3,20	1500.180-9	mm. 18	4,15	1508.125-9	mm. 125	6,25
1408.150-9	mm. 150	4,55	1500.190-9	mm. 19	4,25	1508.250-9	mm. 250	9,85
1410.010-9	1/4"	5,35	1500.200-9	mm. 20	4,45	1509.125-9	mm. 125	16,20
1412.010-9	1/4"	8,05	1500.210-9	mm. 21	5,00	1509.250-9	mm. 250	16,65
1414.010-9	1/4"	7,05	1500.220-9	mm. 22	5,00	1510.010-9	1/2"	10,60
1420.010-9		4,15	1500.230-9	mm. 23	6,00	1512.010-9	1/2"	12,65
1425.010-9	1/4" F x 3/8" M	3,60	1500.240-9	mm. 24	6,10	1520.010-9	1/2"-1/4"	5,05
1430.300-9	mm. 3	2,55	1500.250-9	mm. 25	6,25	1525.010-9	1/2" F x 3/8" M	4,20
1430.400-9	mm. 4	2,55	1500.260-9	mm. 26	6,50	1525.015-9	1/2" F x 3/4" M	9,90
1430.500-9	mm. 5	2,55	1500.270-9	mm. 27	6,65	1527.160-9	mm. 16	5,30
1430.600-9	mm. 6	2,55	1500.280-9	mm. 28	6,95	1527.210-9	mm. 21	7,05
1432.100-9	PH 1	2,55	1500.300-9	mm. 30	7,15	1530.040-9	4	6,20
1432.200-9	PH 2	2,55	1500.320-9	mm. 32	7,50	1530.050-9	5	6,20
1432.300-9	PH 3	2,55	1501.080-9	mm. 8	3,45	1530.060-9	6	6,20
1434.100-9	PZ 1	2,55	1501.090-9	mm. 9	3,45	1530.080-9	8	6,20
1434.200-9	PZ 2	2,55	1501.100-9	mm. 10	3,45	1530.100-9	10	6,20
1434.300-9	PZ 3	2,55	1501.110-9	mm. 11	3,45	1530.120-9	12	6,25
1436.030-9	3	2,55	1501.120-9	mm. 12	3,45	1530.140-9	14	7,05
1436.040-9	4	2,55	1501.130-9	mm. 13	3,55	1530.170-9	17	7,45
1436.050-9	5	2,55	1501.140-9	mm. 14	3,55	1530.190-9	19	7,95
1436.060-9	6	2,55	1501.150-9	mm. 15	3,55	1531.050-9	mm. 5	6,65
1436.080-9	8	2,55	1501.160-9	mm. 16	3,75	1531.060-9	mm. 6	6,65
1438.080-9	TX 8	3,50	1501.170-9	mm. 17	4,15	1531.080-9	mm. 8	6,65
1438.100-9	TX 10	3,50	1501.180-9	mm. 18	4,15	1531.100-9	mm. 10	6,65
1438.150-9	TX 15	3,50	1501.190-9	mm. 19	4,25	1531.205-9	mm. 5 X 140	9,50
1438.200-9	TX 20	3,50	1501.200-9	mm. 20	5,00	1531.206-9	mm. 6 X 140	9,50
1438.250-9	TX 25	3,50	1501.210-9	mm. 21	5,00	1531.208-9	mm. 8 X 140	9,50
1438.270-9	TX 27	3,50	1501.220-9	mm. 22	5,00	1531.210-9	mm. 10 X 140	9,50
1438.300-9	TX 30	3,50	1501.230-9		6,00	1532.050-9	mm. 5 X 90	8,05
1438.400-9	TX 40	3,50	1501.240-9	mm. 24	6,10	1532.060-9	mm. 6 X 90	8,05
1450.060-9	mm. 6	2,85	1501.260-9		6,50	1532.080-9	mm. 8 X 90	8,05
1450.070-9	mm. 7	2,85	1501.270-9	mm. 27	6,65	1534.200-9	TX 20	6,65
1450.080-9	mm. 8	2,85	1501.280-9		6,95	1534.250-9	TX 25	6,65
1450.090-9	mm. 9	2,85	1501.300-9	mm. 30	7,15	1534.270-9	TX 27	6,65
1450.100-9	mm. 10	2,95	1501.320-9	mm. 32	7,50	1534.300-9	TX 30	6,65
1450.110-9	mm. 11	2,95	1502.100-9	mm. 10	6,95	1534.400-9	TX 40	6,65
1450.120-9	mm. 12	2,95	1502.110-9	mm. 11	6,95	1534.450-9	TX 45	6,65
1450.130-9	mm. 13	3,05	1502.120-9	mm. 12	6,95	1534.500-9	TX 50	6,65
1450.140-9	mm. 14	3,35	1502.130-9	mm. 13	6,95	1534.840-9	40 x 90	8,05
1450.150-9	mm. 15	3,55	1502.140-9	mm. 14	6,95	1534.845-9	45 x 90	8,05
1450.160-9	mm. 16	3,55	1502.150-9	mm. 15	6,95	1534.850-9	50 x 90	8,05
1450.170-9	mm. 17	3,70	1502.160-9	mm. 16	6,95	1534.855-9	55 x 90	8,05
1450.180-9	mm. 18	3,70	1502.170-9	mm. 17	7,05	1534.860-9	60 x 90	9,40
1450.190-9	mm. 19	3,95	1502.180-9	mm. 18	7,25	1534.870-9	70 x 90	10,55
1450.200-9	mm. 20	4,05	1502.190-9	mm. 19	7,25	1534.940-9	40 x 140	9,75
1450.210-9	mm. 21	4,20	1502.210-9	mm. 21	7,70	1534.945-9	45 x 140	9,75
1450.220-9	mm. 22	4,75	1502.220-9	mm. 22	7,90	1534.950-9	50 x 140	9,75
1455.010-9	3/8"	30,10	1502.240-9	mm. 24	8,70	1534.955-9	55 x 140	9,75
1455.210-9		23,00	1502.270-9	mm. 27	11,35	1535.100-9	TX E 10 FEM	4,45
1458.075-9	mm. 75	4,75	1502.300-9	mm. 30	12,10	1535.120-9	TX E 12 FEM	4,45
1458.150-9	mm. 150	6,25	1502.320-9	mm. 32	12,80	1535.140-9	TX E 14 FEM	4,45
1460.010-9	3/8"	9,00	1504.010-9	3/8"	4,40	1535.160-9	TX E 16 FEM	4,45
1462.010-9	3/8"	9,85	1504.020-9	7/16"	4,40	1535.180-9	TX E 18 FEM	4,45
1470.010-9	3/8"-1/4"	4,55	1504.030-9	1/2"	4,40	1535.200-9	TX E 20 FEM	5,20
1475.010-9	3/8" F x 1/4" M	3,60	1504.040-9	9/16"	4,40	1535.240-9	TX E 24 FEM	5,90
1475.020-9	3/8" F x 1/2" M	3,70	1504.050-9	5/8"	4,40	1537.040-9	XZN M 4 X 55	5,85
1477.160-9	mm. 16	5,45	1504.060-9	19/32"	4,40	1537.050-9	XZN M 5 X 55	5,85
1477.210-9	mm. 21	6,65	1504.070-9	11/16"	5,40	1537.060-9	XZN M 6 X 55	5,85
			1504.080-9	3/4"	5,40	1537.080-9	XZN M 8 X 55	5,85
			1504.090-9	25/32"	5,40	1537.100-9	XZN M 10 X 55	5,85
			1504.100-9	13/16"	5,40	1537.120-9	XZN M 12 X 55	6,50
			1504.110-9	7/8"	6,05	1538.060-9	RIBE 6 X 55	5,85
			1504.120-9	15/16"	6,05	1538.070-9	RIBE 7 X 55	5,85
1500.080-9	mm. 8	3,45	1504.130-9	1"	6,90	1538.080-9	RIBE 8 X 55	5,85
1500.090-9	mm. 9	3,45	1504.140-9	1.1/16"	6,90	1538.100-9	RIBE 10 X 55	5,85
1500.100-9	mm. 10	3,45	1504.150-9	1.1/8"	8,10	1538.120-9	RIBE 12 X 55	6,65
1500.110-9	mm. 11	3,45	1504.160-9	1.3/16"	8,10	1600.220-9	mm. 22	8,85
1500.120-9	mm. 12	3,45	1504.170-9	1.1/4"	8,10	1600.230-9	mm. 23	8,85
1500.130-9	mm. 13	3,55	1505.010-9	1/2"	40,20	1600.240-9	mm. 24	9,25
1500.140-9	mm. 14	3,55	1505.210-9		27,35	1600.260-9	mm. 26	9,40
1500.150-9	mm. 15	3,55						

Utensili in confezione appendibile self-service con codice a barre

Bar code for hanged self-service packaging













1600.270-9	mm. 27	8011578901806	9,40
1600.280-9	mm. 28	8011578901820	9,40
1600.300-9	mm. 30	8011578976101	10,05
1600.320-9	mm. 32	8011578901868	10,65
1600.330-9	mm. 33	8011578901882	12,70
1600.340-9	mm. 34	8011578901805	12,70
1600.360-9	mm. 36	8011578901929	14,10
1600.380-9	mm. 38	8011578901943	14,10
1600.410-9	mm. 41	8011578976125	16,45
1600.460-9	mm. 46	8011578901981	16,65
1600.500-9	mm. 50	8011578902001	18,75
1600.550-9	mm. 55	8011578902018	28,90
1600.600-9	mm. 60	8011578902032	34,20
1605.010-9	3/4"	8011578902063	85,30
1608.100-9	mm. 100	8011578902094	13,45
1608.200-9	mm. 200	8011578976149	18,00
1608.400-9	mm. 400	8011578902131	29,45
1610.010-9	3/4"	8011578902155	33,25
1612.010-9	3/4"	8011578976163	35,25
1625.010-9	3/4"-1/2"	8011578902193	11,45
1642.360-9	mm. 36	8011578642006	20,40
1642.410-9	mm. 41	8011578642020	22,05
1642.460-9	mm. 46	8011578642044	24,30
1642.500-9	mm. 50	8011578642068	27,15
1642.550-9	mm. 55	8011578642082	35,55
1642.600-9	mm. 60	8011578642105	40,05
1642.650-9	mm. 65	8011578642129	47,90
1642.700-9	mm. 70	8011578642143	55,80
1642.750-9	mm. 75	8011578642167	64,20
1642.800-9	mm. 80	8011578642181	74,90
1645.010-9	1"	8011578645007	162,50
1646.010-9	1"	8011578646004	73,20
1647.200-9	mm. 200	8011578647001	40,05
1647.400-9	mm. 400	8011578647025	60,30
1648.010-9	1-3/4"	8011578648008	16,45
1650.080-9	mm. 8	8011578650018	5,05
1650.100-9	mm. 10	8011578650001	5,05
1650.110-9	mm. 11	8011578650025	5,05
1650.120-9	mm. 12	8011578650049	5,05
1650.130-9	mm. 13	8011578650063	5,05
1650.140-9	mm. 14	8011578650087	5,05
1650.150-9	mm. 15	8011578650100	5,05
1650.160-9	mm. 16	8011578650124	5,05
1650.170-9	mm. 17	8011578650148	5,60
1650.180-9	mm. 18	8011578650162	6,35
1650.190-9	mm. 19	8011578650186	6,35
1650.210-9	mm. 21	8011578650209	7,10
1650.220-9	mm. 22	8011578650223	7,45
1650.240-9	mm. 24	8011578650247	8,05
1650.270-9	mm. 27	8011578650261	10,65
1650.300-9	mm. 30	8011578650285	12,00
1650.320-9	mm. 32	8011578650308	12,90
1652.100-9	mm. 10	8011578652005	10,15
1652.130-9	mm. 13	8011578652029	10,15
1652.140-9	mm. 14	8011578652043	10,15
1652.150-9	mm. 15	8011578652166	10,15
1652.170-9	mm. 17	8011578652067	10,15
1652.180-9		8011578985707	11,10
1652.190-9	mm. 19	8011578652081	11,10
1652.210-9	mm. 21	8011578652159	11,70
1652.220-9	mm. 22	8011578652104	11,70
1652.240-9	mm. 24	8011578652128	12,90
1652.270-9	mm. 27	8011578652142	17,35
1653.012-9	1/2"	8011578653002	12,90
1654.010-9	1/2"	8011578654009	18,05
1654.910-9		8011578985745	12,35
1656.170-9	1/2" - mm. 17	8011578656003	11,85
1656.190-9	1/2" - mm. 19	8011578656027	11,85
1656.210-9	1/2" - mm. 21	8011578656041	11,85
1664.170-9	mm. 17	8011578664008	15,55
1664.190-9	mm. 19	8011578664022	15,55
1664.210-9	mm. 21	8011578664046	15,55

1664.220-9	mm. 22	8011578664060	15,55
1664.230-9	mm. 23	8011578664084	15,55
1664.240-9	mm. 24	8011578664091	15,55
1664.260-9	mm. 26	8011578664121	15,55
1664.270-9	mm. 27	8011578664107	15,55
1664.300-9	mm. 30	8011578664145	17,55
1664.320-9	mm. 32	8011578664169	19,50
1664.330-9	mm. 33	8011578664183	20,00
1664.360-9	mm. 36	8011578664206	21,35
1664.380-9	mm. 38	8011578664220	22,10
1664.410-9	mm. 41	8011578664244	24,45
1664.460-9	mm. 46	8011578664268	31,25
1665.170-9	mm. 17	8011578166502	26,85
1665.190-9	mm. 19	8011578166519	26,85
1665.210-9		8011578984922	26,85
1665.220-9	mm. 22	8011578166526	26,85
1665.240-9	mm. 24	8011578166533	26,85
1665.270-9	mm. 27	8011578166540	26,85
1665.300-9	mm. 30	8011578166557	28,70
1665.320-9	mm. 32	8011578166564	30,25
1665.330-9	mm. 33	8011578166571	31,10
1665.360-9	mm. 36	8011578166588	33,60
1665.410-9	mm. 41	8011578166595	39,00
1665.460-9	mm. 46	8011578665005	45,35
1666.010-9	3/4"	8011578166601	26,95
1667.010-9	3/4"	8011578166700	50,40
1668.010-9	3/4"-1/2"	8011578166809	17,00
1668.020-9	3/4"-1"	8011578985783	18,70
1669.010-9	3/4"	8011578166908	1,95
1669.050-9	3/4"	8011578166922	1,70
1670.270-9		8011578985943	27,20
1670.300-9		8011578985783	27,20
1670.320-9		8011578985981	27,20
1670.330-9		8011578986025	27,10
1670.360-9	mm. 36	8011578167004	27,20
1670.410-9	mm. 41	8011578167028	32,30
1670.460-9	mm. 46	8011578167042	33,55
1670.500-9	mm. 50	8011578167066	41,40
1670.550-9	mm. 55	8011578167080	57,50
1670.600-9	mm. 60	8011578167103	60,60
1670.650-9	mm. 65	8011578167127	74,25
1671.010-9	1"	8011578167110	49,05
1673.010-9	1-3/4"	8011578167301	22,55
1708.010-9	1/2"	8011578708009	23,05
1709.010-9	1/2"	8011578709006	46,60
1720.000-9	80 x 70	8011578720001	27,80
1720.001-9	90 x 100	8011578720025	39,55
1720.002-9	120 x 100	8011578720049	40,70
1720.003-9	170 x 150	8011578720063	74,85
1720.004-9	220 x 150	8011578720077	77,20
1720.100-9		8011578720100	5,40
1720.102-9		8011578720124	10,15
1720.104-9		8011578720148	27,60
1720.300-9		8011578720162	5,05
1720.302-9		8011578720186	5,65
1720.304-9		8011578720209	5,65
1723.001-9	90 x 100	8011578723002	39,55
1723.002-9	130 x 100	8011578723019	44,20
1723.003-9	160 x 150	8011578723026	78,35
1723.004-9	200 x 150	8011578723040	93,65
1723.101-9	mm. 100	8011578723064	23,05
1723.103-9	mm. 150	8011578723088	46,60
1723.201-9	mm. 200	8011578723101	36,00
1723.203-9	mm. 300	8011578723125	63,10
1723.251-9	mm. 100	8011578976286	36,00
1723.253-9	mm. 152	8011578976262	63,10
1725.010-9		8011578725006	188,95
1726.010-9		8011578726003	188,95
1730.001-9	mm. 135	8011578975821	29,65
1730.002-9	mm. 220	8011578730024	52,35
1731.001-9	mm. 110	8011578731007	39,15
1731.002-9	mm. 160	8011578731021	80,10

1738.010-9	18/22x50	8011578738006	20,15
1739.010-9	20x12/50	8011578975845	38,35
1739.020-9	20x60/80	8011578739027	48,95
1820.030-9	3	8011578820039	4,20
1820.050-9	5	8011578820053	6,50
1821.050-9	mt. 5 x mm. 25	8011578821005	11,85
1821.080-9	mt. 8 x mm. 25	8011578821029	16,80
1844.010-9	3	8011578843007	5,10
1845.010-9	mm. 18	8011578845001	1,90
1847.010-9		8011578847005	7,45

Indice analitico











Analytical index

																			
0010	pag.	12		0177	pag.	34		0340A	pag.	47		0416	pag.	63		0504ZZ	pag.	78	
0020	pag.	12		0179	pag.	34		0341	pag.	47		0417	pag.	64		0505	pag.	79	
0012	pag.	13		0184	pag.	35		0075	pag.	47		0417.900	pag.	64		0506	pag.	79	
0014	pag.	13		0186	pag.	35		0343	pag.	48		0418	pag.	64		0510	pag.	79	
0015	pag.	14		0188	pag.	35		0343D	pag.	48		0420	pag.	64		0511	pag.	79	
0016	pag.	14		0190	pag.	35		0343H	pag.	48		0420.900	pag.	64		0512A	pag.	79	
0017	pag.	15		0193	pag.	35		0343HT	pag.	48		0423	pag.	65		0512.900	pag.	79	
0070	pag.	15		0206	pag.	36		0343TT	pag.	48		0425	pag.	65		0513	pag.	80	
0024.010	pag.	16		0222	pag.	36		0344	pag.	49		0430	pag.	65		0514	pag.	80	
0025.030	pag.	17		0223	pag.	36		0344A	pag.	49		0431	pag.	65		0515	pag.	80	
0050	pag.	18		0225	pag.	36		0344X	pag.	49		0432	pag.	65		0516	pag.	80	
0051	pag.	18		0232	pag.	36		0344XT	pag.	49		0433	pag.	66		0517A	pag.	80	
0052	pag.	18		0234	pag.	38		0344F	pag.	50		0433.	pag.	66		0517.900	pag.	82	
0053	pag.	18		0234.900	pag.	38		0344FZ	pag.	50		0433.1	pag.	66		0518.010	pag.	82	
0055	pag.	19		0236	pag.	38		0344FT	pag.	50		0433.2	pag.	66		0518.020	pag.	82	
0056	pag.	19		0236.900	pag.	38		0344T	pag.	51		0434	pag.	66		0520	pag.	82	
0057	pag.	19		0238	pag.	39		0344TZ	pag.	51		0434.	pag.	66		0522	pag.	82	
0058	pag.	19		0239	pag.	39		0344TX	pag.	51		0434.1	pag.	66		0524	pag.	83	
0059	pag.	19		0240	pag.	39		0344	pag.	51		0434.2	pag.	66		0525	pag.	83	
0062	pag.	20		0241	pag.	39		0345	pag.	52		0435	pag.	67		0526	pag.	83	
0063	pag.	20		0243	pag.	39		0345.7	pag.	52		0435.	pag.	67		0527	pag.	83	
0064	pag.	20		0244	pag.	39		0345Z	pag.	52		0435...	pag.	67		0528	pag.	83	
0066	pag.	21		0245	pag.	39		0346	pag.	52		0435X	pag.	67		0529.900	pag.	84	
0068	pag.	21		0246	pag.	39		0347	pag.	53		0436.	pag.	67		0533	pag.	84	
0070	pag.	22		0249	pag.	39		0350	pag.	53		0436	pag.	67		0534	pag.	84	
0072	pag.	23		0250	pag.	40		0351	pag.	53		0436...	pag.	67		0532A	pag.	84	
0073	pag.	23		0250T	pag.	40		0352	pag.	53		0436X	pag.	67		0532B	pag.	84	
0073	pag.	23		0250Z	pag.	40		0353	pag.	53		0437	pag.	68		0540A	pag.	84	
0074	pag.	23		0251	pag.	40		0355	pag.	54		0437A	pag.	68		0540B	pag.	84	
0075	pag.	24		0251T	pag.	40		0355.8	pag.	54		0439D	pag.	68		0541B	pag.	84	
0076	pag.	24		0251Z	pag.	40		0356	pag.	54		0439E	pag.	68		0558	pag.	85	
0076	pag.	24		0253	pag.	40		0357	pag.	54		0439C	pag.	68		0544	pag.	85	
0077	pag.	24		0255	pag.	40		0360	pag.	55		0439.900	pag.	69		0544	pag.	85	
0078	pag.	25		0255Z	pag.	40		0362	pag.	55		0439.911	pag.	69		0552	pag.	85	
0080	pag.	25		0256	pag.	41		0365	pag.	55		0439.912	pag.	69		0553	pag.	86	
0082	pag.	25		0258	pag.	41		0366	pag.	55		0439ZF	pag.	69		0555.010	pag.	86	
0083	pag.	25		0258T	pag.	41		0367	pag.	55		0440Z	pag.	70		0555.020	pag.	86	
0083	pag.	26		0258Z	pag.	41		0370	pag.	56		0441	pag.	70		0555.030	pag.	86	
0083A	pag.	26		0260	pag.	41		0371	pag.	56		0456	pag.	70		0555.040	pag.	86	
0084	pag.	26		0260T	pag.	41		0372	pag.	56		0462	pag.	70		0555.050	pag.	86	
0087	pag.	26		0260Z	pag.	41		0373	pag.	56		0463Z	pag.	71		0555.060	pag.	87	
0090	pag.	28		0262	pag.	41		0373Z	pag.	56		0466Z	pag.	71		0559	pag.	87	
0092	pag.	28		0263	pag.	41		0374	pag.	57		0467Z	pag.	71		0560	pag.	87	
0093	pag.	28		0263Z	pag.	41		0375	pag.	57		0469Z	pag.	71		0561	pag.	87	
0094	pag.	28		0266	pag.	42		0376	pag.	57		0472	pag.	72		0562	pag.	87	
0095	pag.	29		01420	pag.	42		0376	pag.	57		0474	pag.	72		0563	pag.	88	
0096	pag.	29		01470	pag.	42		0377	pag.	58		0475	pag.	72		0564	pag.	88	
0730	pag.	29		01520	pag.	42		0378	pag.	58		0476	pag.	72		0565	pag.	88	
0115	pag.	30		0084	pag.	42		0380	pag.	58		0478	pag.	73		0566	pag.	88	
0116	pag.	30		0087	pag.	42		0381	pag.	58		0478Z	pag.	73		0567	pag.	88	
0119C	pag.	30		0270	pag.	43		0382	pag.	59		0479	pag.	73		0568	pag.	89	
0119D	pag.	30		0272	pag.	43		0382B	pag.	59		0480	pag.	74		0569	pag.	89	
0121	pag.	30		0274	pag.	43		0382Z	pag.	59		0482	pag.	74		0570	pag.	89	
0130	pag.	31		0275	pag.	43		0383	pag.	59		0483	pag.	74		0572	pag.	90	
0132	pag.	31		0276A	pag.	43		0383Z	pag.	59		0490	pag.	75		0574.1	pag.	90	
0135	pag.	31		0276	pag.	43		0384	pag.	60		0490.900	pag.	75		0574.2	pag.	90	
0136	pag.	31		0278	pag.	44		0385	pag.	60		0491	pag.	75		0574.3	pag.	90	
0137A	pag.	31		0303A	pag.	44		0385B	pag.	60		0491.900	pag.	75		0574.4	pag.	91	
0137B	pag.	32		0303B	pag.	44		0386	pag.	60		0492	pag.	76		0574.5	pag.	91	
0137C	pag.	32		0304A	pag.	44		0390	pag.	60		0492.900	pag.	76		0574.8	pag.	91	
0138	pag.	32		0304B	pag.	44		0402	pag.	61		0495	pag.	76		0574.990	pag.	91	
0139	pag.	32		0305A	pag.	45		0403	pag.	61		0497	pag.	76		0575...	pag.	92	
0147C	pag.	32		0305B	pag.	45		0404	pag.	61		0500	pag.	76		0576	pag.	92	
0147D	pag.	32		0307	pag.	45		0404.900	pag.	61		0501	pag.	76		0577	pag.	92	
0148	pag.	32		0310	pag.	45		0405	pag.	61		0502	pag.	77		0580	pag.	92	
0162	pag.	33		0311	pag.	45		0407	pag.	61		0502S	pag.	77		0581	pag.	93	
0163	pag.	33		0313	pag.	45		0408	pag.	62		0503	pag.	77		0582	pag.	93	
0163X	pag.	33		0316	pag.	46		0409	pag.	62		0504	pag.	77		0583	pag.	93	
0164	pag.	33		0318	pag.	46		0410	pag.	62		0504A	pag.	78		0588	pag.	93	
0170	pag.	34		0082	pag.	46		0412Z	pag.	62		0504S	pag.	78		0591	pag.	93	
0172	pag.	34		0078	pag.	47		0414	pag.	63		0504ZF	pag.	78		0589	pag.	93	
0173	pag.	34		0340	pag.	47		0415	pag.	63		0504ZT	pag.	78		0592	pag.	94	







Indice analitico

Analytical index

									
0593Z	pag. 94	0774	pag. 108	1061	pag. 130	1366	pag. 151	1531A	pag. 164
0594	pag. 94	0775	pag. 109	1061	pag. 130	1367	pag. 151	1532	pag. 164
0595	pag. 94	0776	pag. 109	1062	pag. 130	1369	pag. 151	1532Z	pag. 165
0596	pag. 95	0776...	pag. 109	1063	pag. 131	1370	pag. 152	1534	pag. 165
0597	pag. 95	0777	pag. 109	1064	pag. 131	1371	pag. 152	1534A	pag. 165
0598	pag. 95	0777...	pag. 109	1065	pag. 131	1380	pag. 152	1534T	pag. 165
0598Z	pag. 95	0782	pag. 109	1065	pag. 132	1383	pag. 152	1534Z	pag. 165
0599A	pag. 95	0782...	pag. 110	1067	pag. 132	1385	pag. 152	1534TZ	pag. 166
0599B	pag. 95	0786	pag. 110	1068	pag. 132	1386	pag. 153	1535	pag. 166
0599D	pag. 96	0790	pag. 110	1068	pag. 132	1388	pag. 153	1535Z	pag. 166
0600	pag. 96	0792	pag. 110	1069	pag. 132	1390	pag. 153	1537	pag. 166
0601	pag. 96	0792A	pag. 110	1070	pag. 133	1391	pag. 153	1538	pag. 166
0601A	pag. 97	0794	pag. 111	1071	pag. 133	1393	pag. 153	1538Z	pag. 166
0612	pag. 97	0794A	pag. 111	1074	pag. 133	1394	pag. 154	1542	pag. 167
0614	pag. 97	0795	pag. 111	1074Z	pag. 134	1400	pag. 154	1545	pag. 167
0615	pag. 97	0796.100	pag. 111	1075	pag. 134	1400Z	pag. 154	1548	pag. 168
0616	pag. 97	0796.300	pag. 111	1076	pag. 134	1400ZZ	pag. 154	1555	pag. 168
0616Z	pag. 97	0797	pag. 111	1077	pag. 135	1402	pag. 154	1557	pag. 169
0617	pag. 98	0798	pag. 111	1078	pag. 135	1402Z	pag. 155	1560	pag. 169
0617A	pag. 98	0799	pag. 112	1078.8	pag. 135	1404	pag. 155	1565	pag. 170
0620	pag. 98	0803	pag. 112	1078.9	pag. 135	1404Z	pag. 155	1570	pag. 170
0623	pag. 98	0807	pag. 112	1079	pag. 136	1405	pag. 155	1600	pag. 171
0624	pag. 98	0815	pag. 112	1079.8	pag. 137	1405.2	pag. 155	1605	pag. 171
0624.5	pag. 99	0830	pag. 112	1079.9	pag. 137	1405Z	pag. 155	1608	pag. 171
0625	pag. 99	0832	pag. 113	1079.9	pag. 137	1406	pag. 156	1610	pag. 171
0626	pag. 99	0833	pag. 113	1080	pag. 138	1407	pag. 156	1612	pag. 171
0628	pag. 99	0839	pag. 113	1081	pag. 138	1408	pag. 156	1625	pag. 171
0629	pag. 99	0840	pag. 113	1090	pag. 138	1410	pag. 156	1640	pag. 171
0629A	pag. 100	0841	pag. 113	1092	pag. 139	1412	pag. 156	1640	pag. 172
0630	pag. 100	0842	pag. 113	1093	pag. 139	1414	pag. 156	1642	pag. 172
0631	pag. 100	0843	pag. 113	1093A	pag. 140	1420	pag. 156	1645	pag. 172
0633	pag. 100	0847	pag. 114	1096	pag. 140	1425	pag. 157	1646	pag. 172
0635	pag. 100	1020	pag. 114	1097	pag. 140	1430	pag. 157	1647	pag. 173
0638	pag. 101	1021	pag. 114	1097A	pag. 140	1432	pag. 157	1648	pag. 173
0638A	pag. 101	1021	pag. 115	1097Z	pag. 141	1434	pag. 157	1649	pag. 173
0638Z	pag. 101	1022	pag. 115	1098	pag. 141	1436	pag. 157	1650	pag. 173
0640	pag. 101	1023	pag. 116	1099	pag. 141	1438	pag. 157	1652	pag. 173
0640A	pag. 101	1025	pag. 116	1099	pag. 142	1440	pag. 157	1652Z	pag. 174
0671	pag. 102	1026	pag. 116	1099A	pag. 142	1442	pag. 158	1653	pag. 174
0672	pag. 102	1030	pag. 117	1100.015	pag. 142	1450	pag. 158	1654	pag. 174
0677	pag. 102	1031	pag. 117	1150	pag. 144	1455	pag. 158	1654	pag. 174
0677.900	pag. 102	1031	pag. 118	1150X	pag. 144	1455.2	pag. 158	1655	pag. 174
0680	pag. 102	1032	pag. 118	1150FX	pag. 145	1458	pag. 159	1656	pag. 174
0680.900	pag. 102	1033	pag. 119	1150Z	pag. 145	1460	pag. 159	1658	pag. 175
0683	pag. 102	1033	pag. 119	1152	pag. 145	1462	pag. 159	1659	pag. 175
0683.900	pag. 103	1035	pag. 120	1153	pag. 145	1470	pag. 159	1664	pag. 175
0686A	pag. 103	1035	pag. 120	1155	pag. 145	1475	pag. 159	1665	pag. 175
0686B	pag. 103	1035	pag. 121	1158	pag. 146	1477	pag. 159	1666	pag. 175
0689	pag. 103	1038	pag. 121	1170	pag. 146	1490	pag. 160	1667	pag. 175
0689.900	pag. 103	1039	pag. 121	1325	pag. 146	1500	pag. 160	1668	pag. 176
0700	pag. 103	1039	pag. 122	1328	pag. 146	1500Z	pag. 160	1669	pag. 176
0702	pag. 103	1040	pag. 122	1328.904	pag. 147	1500ZZ	pag. 160	1669	pag. 176
0705	pag. 104	1041	pag. 122	1334	pag. 147	1501	pag. 161	1670	pag. 176
0710	pag. 104	1041	pag. 123	1334Z	pag. 147	1501Z	pag. 161	1671	pag. 176
0712	pag. 104	1041	pag. 123	1336	pag. 147	1502	pag. 161	1673	pag. 177
0714	pag. 104	1043	pag. 124	1338	pag. 147	1502Z	pag. 161	1674	pag. 177
0716	pag. 105	1048	pag. 124	1339	pag. 148	1504	pag. 162	1674	pag. 177
0728	pag. 105	1048	pag. 124	1345	pag. 148	1504Z	pag. 162	1700	pag. 177
0730	pag. 105	1050.015	pag. 124	1347	pag. 148	1505	pag. 162	1702	pag. 177
0730.900	pag. 105	1051	pag. 125	1348	pag. 148	1505.2	pag. 162	1708	pag. 178
0739	pag. 106	1051C	pag. 125	1349	pag. 148	1505Z	pag. 163	1709	pag. 178
0740	pag. 106	1052	pag. 125	1349...	pag. 148	1506	pag. 163	1720	pag. 178
0741	pag. 106	1053	pag. 126	1349...	pag. 149	1508	pag. 163	1720...	pag. 179
0741Z	pag. 107	1055	pag. 126	1350	pag. 149	1509	pag. 163	1720...	pag. 179
0750	pag. 107	1056	pag. 126	1351	pag. 149	1510	pag. 163	1723	pag. 179
0751	pag. 107	1056	pag. 127	1352	pag. 149	1512	pag. 163	1723...	pag. 179
0752	pag. 107	1056	pag. 127	1360	pag. 150	1520	pag. 163	1723...	pag. 180
0756	pag. 108	1057	pag. 127	1360A	pag. 150	1525	pag. 164	1723...	pag. 180
0769	pag. 108	1058	pag. 128	1362	pag. 150	1527	pag. 164	1725	pag. 180
0770	pag. 108	1058.9	pag. 129	1363	pag. 150	1530	pag. 164	1726	pag. 180
0772	pag. 108	1060	pag. 129	1364	pag. 150	1530Z	pag. 164	1730	pag. 181
0773	pag. 108	1061	pag. 129	1365	pag. 151	1531	pag. 164	1731	pag. 181

Indice analitico

Analytical index

			
1738	pag. 181	1815.086	pag. 202
1739	pag. 182	1815.090	pag. 202
1739	pag. 182	1815.095	pag. 202
1750	pag. 182	1815.100	pag. 203
1754	pag. 182	1815.105	pag. 203
1756	pag. 182	1815.120	pag. 203
1756	pag. 182	1815.140	pag. 203
1756	pag. 183	1815.150	pag. 204
1759.010	pag. 183	1815.180	pag. 204
1759.110	pag. 183	1815.200	pag. 204
1762	pag. 183	1815.210	pag. 204
1762	pag. 184	1815.220	pag. 204
1763	pag. 184	1815.240	pag. 204
1764	pag. 184	1815.260	pag. 205
1764	pag. 185	1815.300	pag. 205
1765	pag. 185	1815.330	pag. 205
1765	pag. 185	1815.380	pag. 205
1766	pag. 185	1815.400	pag. 205
1766	pag. 186	1815.500	pag. 206
1766	pag. 186	1815.540	pag. 206
1766	pag. 186	1815.580	pag. 206
1767	pag. 186	1815.590	pag. 206
1767	pag. 187	1815.595	pag. 207
1770	pag. 187	1820	pag. 207
1774	pag. 187	1820.912	pag. 207
1778	pag. 187	1821	pag. 208
1778	pag. 188	1844	pag. 208
1803.210	pag. 188	1844.900	pag. 208
1805.210	pag. 188		
1805.056	pag. 190		
1810.210	pag. 190		
1813.005	pag. 191		
1813.010	pag. 191		
1813.020	pag. 191		
1812.210	pag. 191		
1813.005	pag. 192		
1813.010	pag. 192		
1813.020	pag. 192		
1810.064	pag. 192		
1812.064	pag. 193		
1814.064	pag. 193		
1810.067	pag. 193		
1812.067	pag. 194		
1814.067	pag. 194		
1810.128	pag. 194		
1812.128	pag. 195		
1814.128	pag. 195		
1810.164	pag. 195		
1812.164	pag. 196		
1814.164	pag. 196		
1810.166	pag. 196		
1812.166	pag. 197		
1814.166	pag. 197		
1810.181	pag. 197		
1812.181	pag. 198		
1814.181	pag. 198		
1810.185	pag. 198		
1812.185	pag. 199		
1814.185	pag. 199		
1810.216	pag. 199		
1812.216	pag. 200		
1814.216	pag. 200		
1808.210	pag. 200		
1808.067	pag. 200		
1808.128	pag. 201		
1815.010	pag. 201		
1815.020	pag. 201		
1815.040	pag. 201		
1815.050	pag. 201		
1815.070	pag. 201		
1815.080	pag. 202		
1815.083	pag. 202		

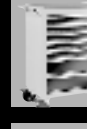



0066.010 pagina 21

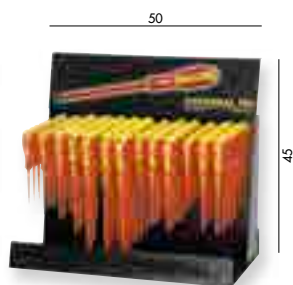

0096.010 pagina 29



0074.010 pagina 23



0077.010 pagina 24



0083.010 pagina 26



0068.010 pagina 21



0439.410 pagina 68



0439.510 pagina 68



0439.310 pagina 68



0439.915 pagina 69



0512.110 pagina 79



0728.010 pagina 105

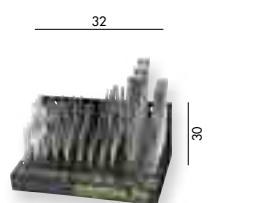

0623.010 pagina 98



1064.015 pagina 131



1100.015 pagina 142



1570.015 pagina 170



1050.015 pagina 124



0344.990 pagina 51

punto vendita-sales point
mundial merchandising
 progetta e modifica la tua esposizione
 di utensili professionali
 design and modify your professional
 tools exhibition

- espositori personalizzati e funzionali per categorie di utensili
 special display for each tools range
- larghezza 50 cm
 width 50 cm
- altezza 40/80 cm
 height 40/80 cm
- riduzione dello spazio espositivo
 reduced exhibition area

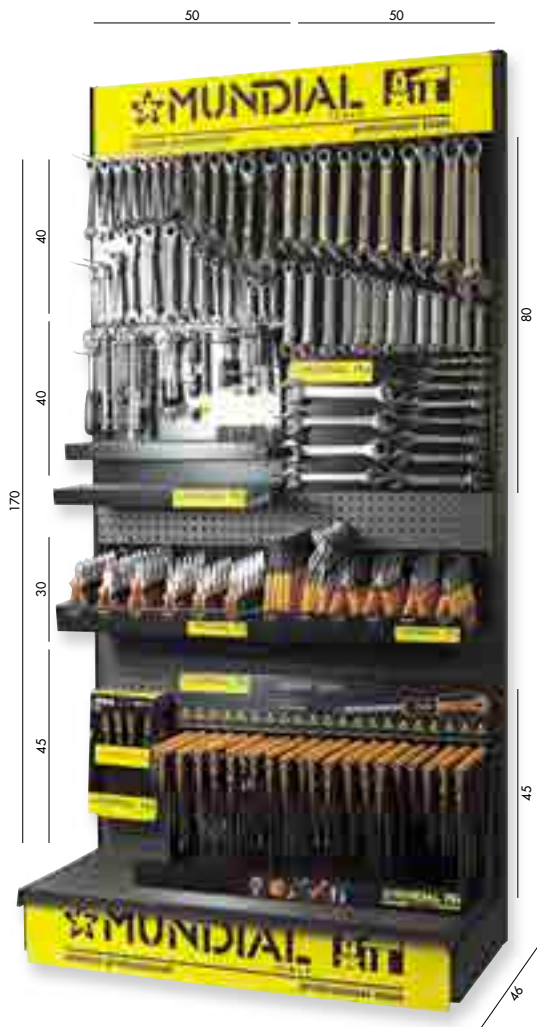

0010.015 pagina 12



0012.015 pagina 13



0070.010 pagina 15



0014.010 pagina 13



0015.010 pagina 14



0016.015 pagina 14



0017.010 pagina 15









Rivenditore - Dealer: